



**GULF CRETE LTD.**

شركة خليج الخرسانه المحدوده

# Company

# Profile

CONSTRUCTION MAINTENANCE REPAIR & RESTORATION

Gulf Crete Contracting LTD.



SCAN ME



[Gulfcrete.com](http://Gulfcrete.com)

# Agenda

4-5	Introduction	23-25	Capital Equipment
6	Mission & Vision	26-28	Work Target Areas
7-17	Our Services	29-34	Activities
18-19	Organization Chart	35-101	Work Images
20-22	Human Recourses	102-104	Partner

# Agenda

105-119	Major Projects	211-216	Training Certification
120-122	Approval	217-241	CO-MENDER & GULFCRETE
123-133	GOVERMENT CERTIFICATION	242	Contact us
134-142	Accreditation Certification	243	Conclusion
143-210	Work Certification		



# INTRODUCTION





# Gulf Crete

- ▶ Gulf Crete Contracting LTD. Is a specialized contracting company that comprises shareholders with a combined experience of 30 years in the Construction industry. Its main principal owner is a 2nd Classification Contractor that has been in business since 1979 in the Saudi Arabian Market for Civil, Electromechanical & Architectural works. In 2008 the General Contracting Company saw the need for a specialized division focusing on Fire Proofing, Water Proofing, Concrete Repair & Restoration, Specialty Floor Coatings, and Maintenance Repair & Operations. This division flourished with success and in 2014 it was unanimously decided by all shareholders to separate the division as its own stand-alone entity.

## Mission

To deliver a premier company in the Jordanian Market delivering innovative services, out-of-the-box thinking, and advanced technologies based on an in-depth understanding & market analysis in the field of fireproofing, water proofing, concrete repair & restoration, specialty flooring & MRO. Gerziem Management is dedicated to being a company admired for its excellence in providing creative approaches, superior advice, and executions capabilities by its clients, shareholders, suppliers, and employees

## Vision

To become the market leader in our industry by utilizing innovation, technology, state of the art equipment & materials and key human resource elements while delivering top class quality service while being conscious of the clients bottom line needs in the Jordanian Market

## Core Value

Our Core values will shape the culture and define the character of our company, guiding how we behave and make decisions. Put our client's interest ahead of our own: This means we deliver more than is expected. It doesn't simply mean we do whatever the client asks Integrity: Exciting trust by taking accountability, acting ethically and promoting open forms of communication between all individuals at all levels Best people: Attracting, training, and developing the best talent in our industry and encouraging a "can do" attitude. Client Value Creation: Improving our client's business through performance, long-term win-win scenarios and focusing on execution excellence



# OUR SERVICES



# Our Services



Concrete Repair/Restoration &  
Strengthening



Rock Fall Protection



Survey Technology



Expansion joint



# Our Services



Fire Proofing

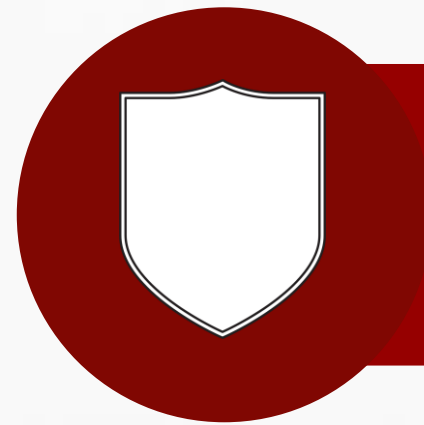

Vertical & Horizontal Protective and  
Decorative Coatings



Water Proofing



Renovation & Fit Out



# Concrete Repair/Restoration & Strengthening

A leader in its field - GCL offers comprehensive engineering solutions, technical assistance, and quality applications for concrete repair, flooring repairs, and structural concrete. In addition, GCL provides the design and implementation of structural strengthening systems using Fiber Reinforced Polymer (FRP). Our experience and expertise combine specialized and conventional concrete repair methods to provide the most practical solution for all concrete repair projects.





# RockFall Protection

During the last decades, large rock falls occurred on the steep slopes along mountainous areas of Saudi Arabia, causing serious damage to buildings and traffic facilities, injury to people, and delayed traffic on roads, Settlements, and transportation facilities in mountainous areas with steep rock slopes are vulnerable to rock falls. In recent years, a number of highways have been or are scheduled to be built in the southern region of Saudi Arabia, that carry significant risk of increasing rock fall hazard events. GCL offers comprehensive engineering solutions, technical assistance, and quality applications for rockfall protection.



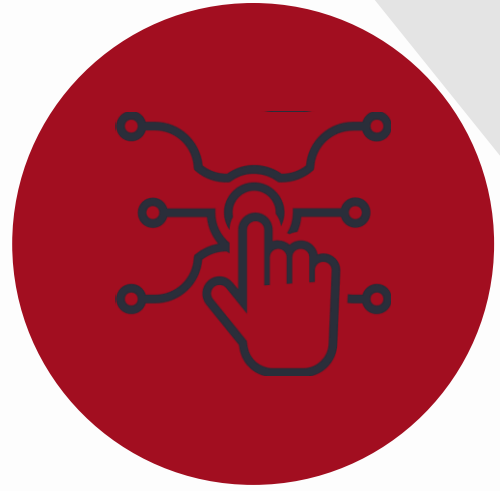

# Survey Technology

During the past 50 years, surveying and engineering measurement technology has made five quantum leaps: the electronic distance meter, total station, GPS, robotic total station, and laser scanner. Aircraft systems or drones will be the sixth quantum leap in technology. Surveying with a drone offers enormous potential to GIS professionals. With a drone, it is possible to carry out topographic surveys of the same quality as the highly accurate measurements collected by traditional methods, but in a fraction of the time. This substantially reduces the cost of a site survey and the workload of specialists in the field. GCL Provides all these services.





# Expansion joint

Expansion joints are designed to allow for continuous traffic between structures while accommodating movement, shrinkage, and temperature variations on reinforced and prestressed concrete, composite, and steel structures. They stop the bridge from bending out of place in extreme conditions and also allow enough vertical movement to permit bearing replacement without the need to dismantle the bridge expansion joint. GCL has expertise and experience in such applications.

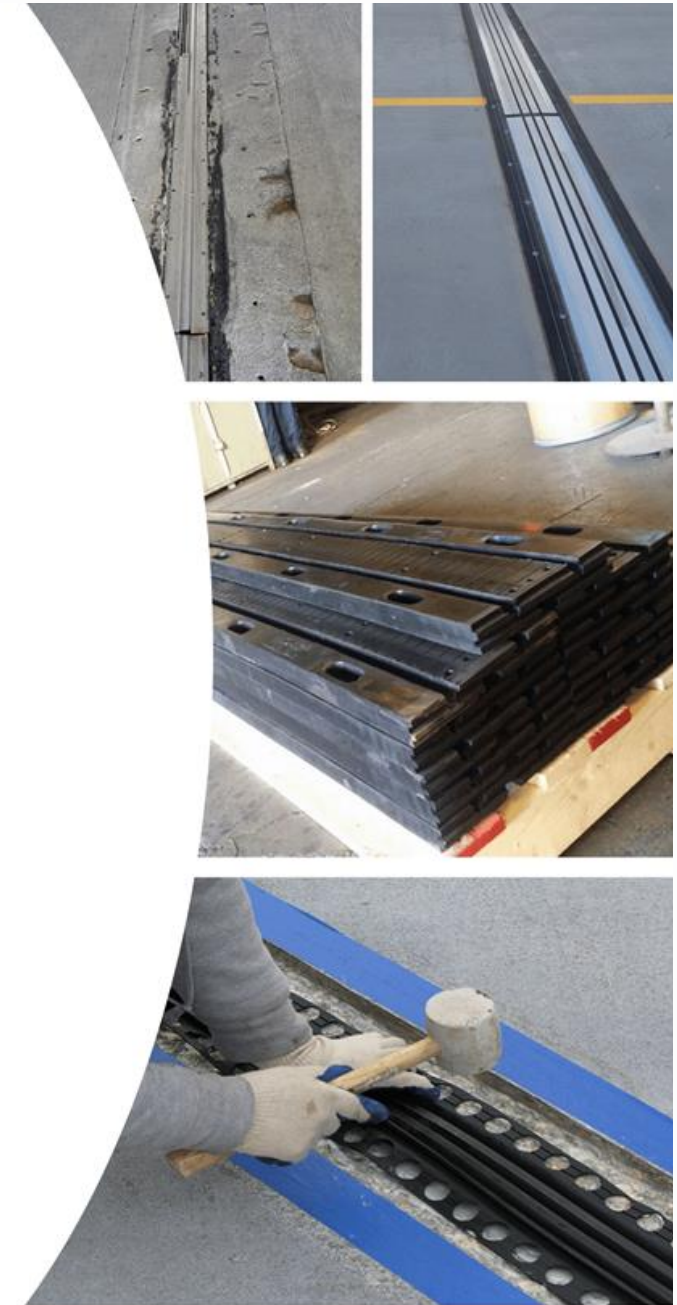



# Fire Proofing

GCL specializes in commercial fireproofing, thermal and acoustical insulation, and firestop services. We adhere to industry standards and provide quality services at reasonable prices. We will examine the situation closely whether it's a new install or retrofit remodel project and work together with you to achieve the desired solution. Timelines are crucial in commercial construction, and it is our goal to help keep your projects moving, so constant coordination is very important to us.





# Vertical & Horizontal Protective and Decorative Coatings

Protective coatings are given to concrete surfaces to prevent damage and for a rehabilitated look. GCL co. supplies and applies a wide range of protective coatings. Appropriate protective coating materials are recommended by experienced Engineers from GCL Co. to provide quality solutions. Epoxy resins, non-slip coatings, polyurethanes, cementations coatings, acrylic coatings, membranes, food grade systems, tanking/waterproofing, and chemical-resistant coatings. GCL offers decorative flooring solutions that give a new look to an old concrete floor. Decorative coatings are a perfect alternative to concrete replacement, tiles, resin floors, and other topical systems. Decorative floors include acid staining, densifying, impregnated sealers & polished concrete, Creative & flexible designs are created with logos saw cuts, aggregate & decorative saw cuts. Specialty grinding machines can be helpful in a way to provide the required preparation of the concrete substrate for proper levels, mechanical bonding, and decorative work.





# Water Proofing

Waterproofing is necessary in any kind of environment, but especially in areas with heavy moisture. In areas where there is a lot of moisture collection on the ground, hydrostatic pressure can create a nightmare for a building's foundation. Whether it's waterproofing or damp proofing, our experts here at GCL know the jeopardy that inferior waterproofing puts a structure in, and they strive to mitigate any issues with superior knowledge and experience. We carefully select premium quality products to best match the requirements and our installers are highly trained and qualified.

- ✓ Waterproofing
- ✓ Dampproofing
- ✓ Site Caulking
- ✓ Tilt Wall Panel

- ✓ Caulking Water Repellants
- ✓ Below Grade
- ✓ Waterproofing Deck Coatings

- ✓ Window Caulking
- ✓ Floor Sealers
- ✓ Traffic Coatings







# Renovation & Fit Out

GCL carries out exceptional commercial and residential property refurbishments and renovations. we fit out precision interiors; we develop client relationships based on mutual trust and understanding and are open to our client's objectives. With our vast global relationship with material suppliers of paints, wood, doors, furniture & fixtures. GCL can provide you with a total turnkey solution. Whether it's a listed building renovation, retail fit-out, or office fit-out, we apply our stringent management control procedures to guarantee the highest standard of finish and defect-free handover, irrespective of the demands of the contract programmed. We are solid and reliable, and we exceed client expectations.

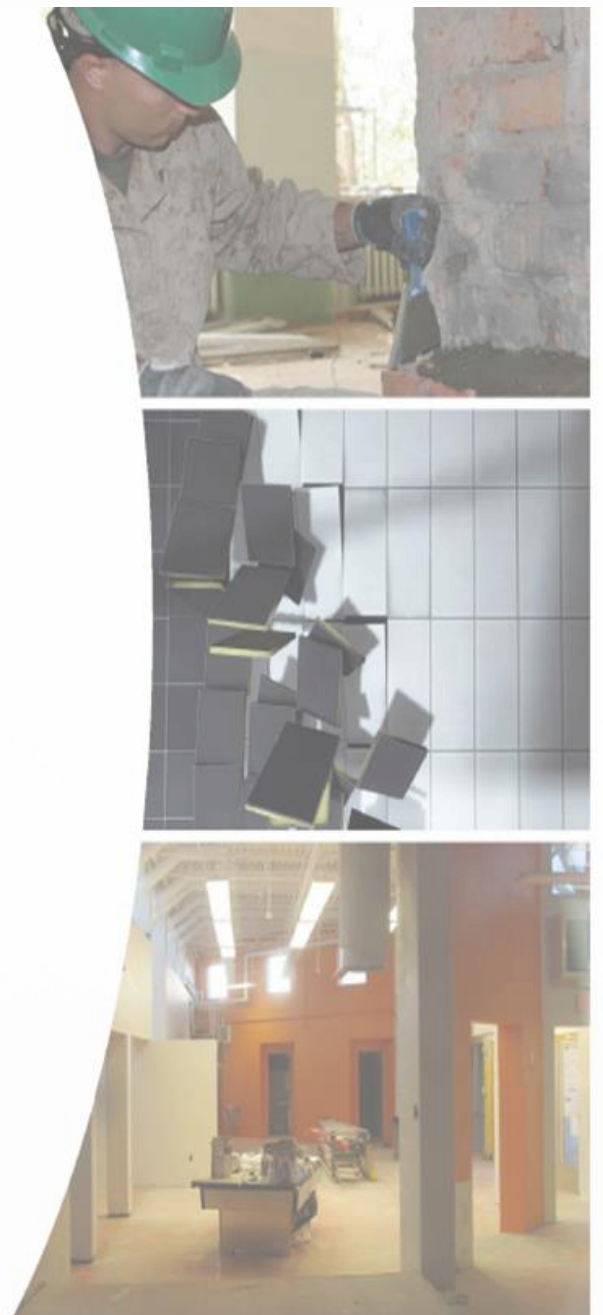



# ORGANIZATION CHART



# Organization Chart

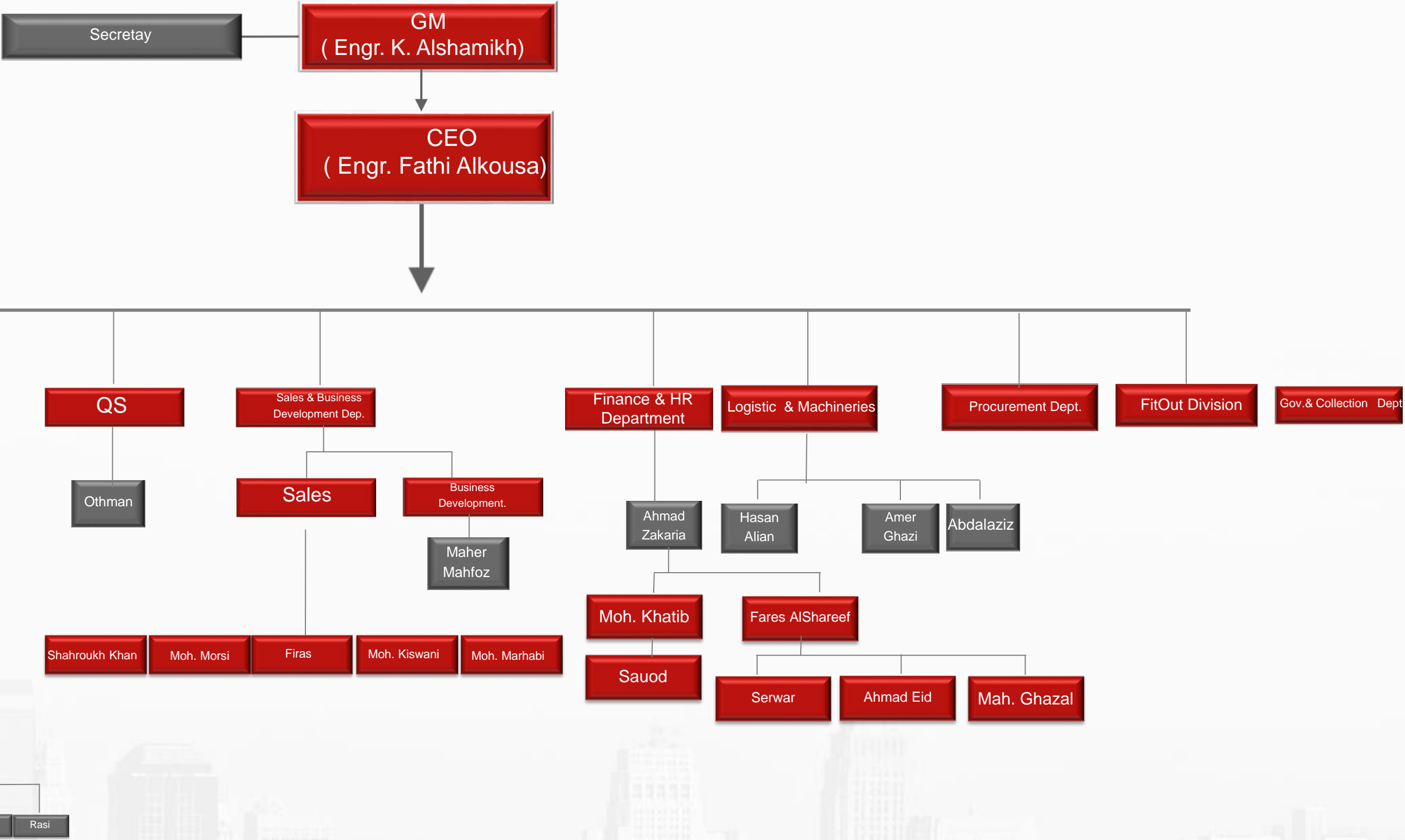



# HUMAN RESOURCES



# Our Human Resources

GCL classifies all its employees as Team members as they are all contributing to the process of producing goods or providing services. All the engineering staff, technicians, and team members are trained, and educated in new processes, materials, safety procedures, and tools, which helps in maintaining the highest level of quality, the company has >100 skilled and un-skilled team members in addition to the engineering and foreman whom are experts in their field with high efficiency.

# Our Human Resources



Position	Nationality	Number of Staff
Civil& Arch Eng	Arab	10
Civil Eng Asst	East Asian& Syrian	5
Quantity Surveyor	East Asian & Filipino	2
Finance, HR, Procurement & Administration	Arab and East Asian	5
Sales	Arab and East Asian	5
Safety Officer	East Asian & Pakistani	2
Drafts Man	Filipino	2
Carpenters	East Asian, Syrian & Pakistani (COP.)	25
Steel Workers	East Asian & Syrian (COP.)	32
Skilled Workers (Painters, Roofers, etc.)	All Nationality	150
<b>Total</b>		<b>238</b>



# CAPITAL EQUIPMENT



# Our Capital Equipment



**Total Equipment more than  
180 machines and tool.**





# Our Capital Equipment

GCL owns the following equipment stocked at our local facilities:



EQUIPMENT DESCRIPTION	Unit	QTY	EQUIPMENT DESCRIPTION	Unit	QTY	EQUIPMENT DESCRIPTION	Unit	QTY
Air Compressor 125cfm	Pcs	1	Generator 100kw	Pcs	1	Tile Grinding	Pcs	2
Air Compressor 250cfm	Pcs	1	Generator 250Kw	Pcs	1	DRONE & Surveying Instrument	Pcs	3
Air Compressor 375cfm	Pcs	1	Air Less Spray Machines	Pcs	10	Water Tankers	Pcs	2
Diamond Grinding MGM 500	Pcs	5	Foam Concrete Pumping machine	Pcs	3	Pick-up	Pcs	3
Diamond Grinding MGM 1000	Pcs	16	Asphalt cutter	Pcs	3	Diana	Pcs	1
Diamond Grinding MGM Grand 3 headed	Pcs	4	Water pumps	Pcs	2	Lesiter Hand Welding Machine	Pcs	12
Airless Spray Machine for Fireproof And Epoxy Application	Pcs	5	Concrete mixer	Pcs	2	Lesiter Automatic Welding Machine	Pcs	2
Screed Pumping machine	Pcs	2	Small Jack Hammers	Pcs	40	Postemizer Grout Injection Machine	Pcs	4
Epoxy Injection machine	Pcs	3	Big Jack Hammers	Pcs	20	Postemizer Cementicious Fire Proof Machine	Pcs	3
Delta Shot Cretemachine	Pcs	2	Concrete Drilling Machine	Pcs	10	Shotcrete Machine Betonmaster (Turbosol+putzmeister +otherbrands)	Pcs	5
Customizer fireproofing	Pcs	2	Concrete Saw	Pcs	2	Robotic Shotcrete machine	Pcs	1
Generator 10kw	Pcs	1	Air Blower	Pcs	30	Anchorbolts & Rock Bolts nailing Drilling Machine	Pcs	5



# WORK TARGET AREAS & MARKET POSITION

# Work Target Area



## MAIN CONTRACTORS PROJECT

Initial condition surveys, concrete & steel repairs, Waterproofing & roofing works, joint sealants, specialist coatings.

---

## BUILDINGS

Initial condition surveys, concrete & steel repairs, Waterproofing & roofing works, joint sealants, specialist coatings.

---

## CONCRETE REPAIR

Leaking, repairing damaged concrete, strengthening, and restoration.

# Work Target Area



## WATER INDUSTRY STRUCTURES

Renovation services, condition surveys, tank linings, leak sealing, reservoir roof lining, concrete repairs, and protective coating.

## ROADS AND BRIDGES

Survey, repair, restoration, and strengthening of concrete, steel, and cast-iron structures, new bearing replacements, expansion jointing, and post-tensioning and advising to ensure that work is carried out correctly and safely.

## GOVERNMENT INDUSTRY STRUCTURES

Renovation services, condition surveys, tank linings, leak sealing, reservoir roof lining, concrete repairs, and protective coating.



# Activities



# Structural Activities



- ✓ **Structural and Cosmetic Repair System**
- ✓ **Design and Implementation of Structural**
- ✓ **Strengthening and Conventional System**
- ✓ **Concrete Injection System**
- ✓ **Water Tanks Treatment and Repairs.**
- ✓ **Repair and protection of Retaining Walls and Bridges.**
- ✓ **Carbon Fiber Strengthen ( CFRP )**
- ✓ **Reinforced Shot Creating for Earth collapse**
- ✓ **Cathodic Protection**
- ✓ **Form & Pump Repair System**
- ✓ **Anchoring**
- ✓ **Micro Piles**
- ✓ **Soil Stabilization**
- ✓ **Soil Stabilization**
- ✓ **Soil Injection Reinforced**
- ✓ **Concrete jacketing**

# Rock Fall Protection

# Survey Technology

- ✓ Rock Bolts Anchorage
- ✓ Sup-Horizontal Drain
- ✓ Shotcrete Application
- ✓ Dynamic Rock Fall Barriers
- ✓ Wire Mesh Ring Netting



- ✓ The electronic distance meter
- ✓ Total station
- ✓ GPS
- ✓ Robotic total station
- ✓ Laser scanner
- ✓ Aircraft systems or drones

# Industrial Flooring

# Coating Activities

- ✓ **Floor Epoxy Resin Coating**
- ✓ **Floor Traffic Deck Coating**
- ✓ **Epoxy Self Leveling specially for SCECO buildings**
- ✓ **Cementitious material Coating. Expansion and Construction Joints**
- ✓ **Treatment.**
- ✓ **Bridge Painting**
- ✓ **Epoxy screed repair**



- ✓ **Polyurethane Screed ( such as U-Crete )**
- ✓ **Cementitious self leveling Anti- Static Flooring**
- ✓ **Any other industrial Flooring Micro topping Flooring Coating**
- ✓ **Heavy Grinding for Floor Concrete Epoxy Terrazzo Finishing**



# Water Proofing



- ✓ **Foam Concrete Work**
- ✓ **Bituminate Water Proofing Membrane ( APP & SBS )**
- ✓ **PVC Water Proofing Membrane**
- ✓ **EPDM Water Proofing membrane**
- ✓ **HDPE Water proofing membrane**
- ✓ **TPO Water proofing Membrane**
- ✓ **Compartment Water proofing System**
- ✓ **Water Tanks Lining System**
  - ✓ **Epoxy Coating**
  - ✓ **Cementitious Coating**
  - ✓ **Crystalline Coating**
  - ✓ **Polysulfide Coating**
  - ✓ **Polyurethane coating**
  - ✓ **Steel Tanks Epoxy & Polyurethane Coating**

# Miscellaneous Fields

# Fire Proofing



**Chemical Treatment of Concrete Structures**



**Airport runways and helipads**



**Screed Casting , Fit Out Work And Building Renovation**

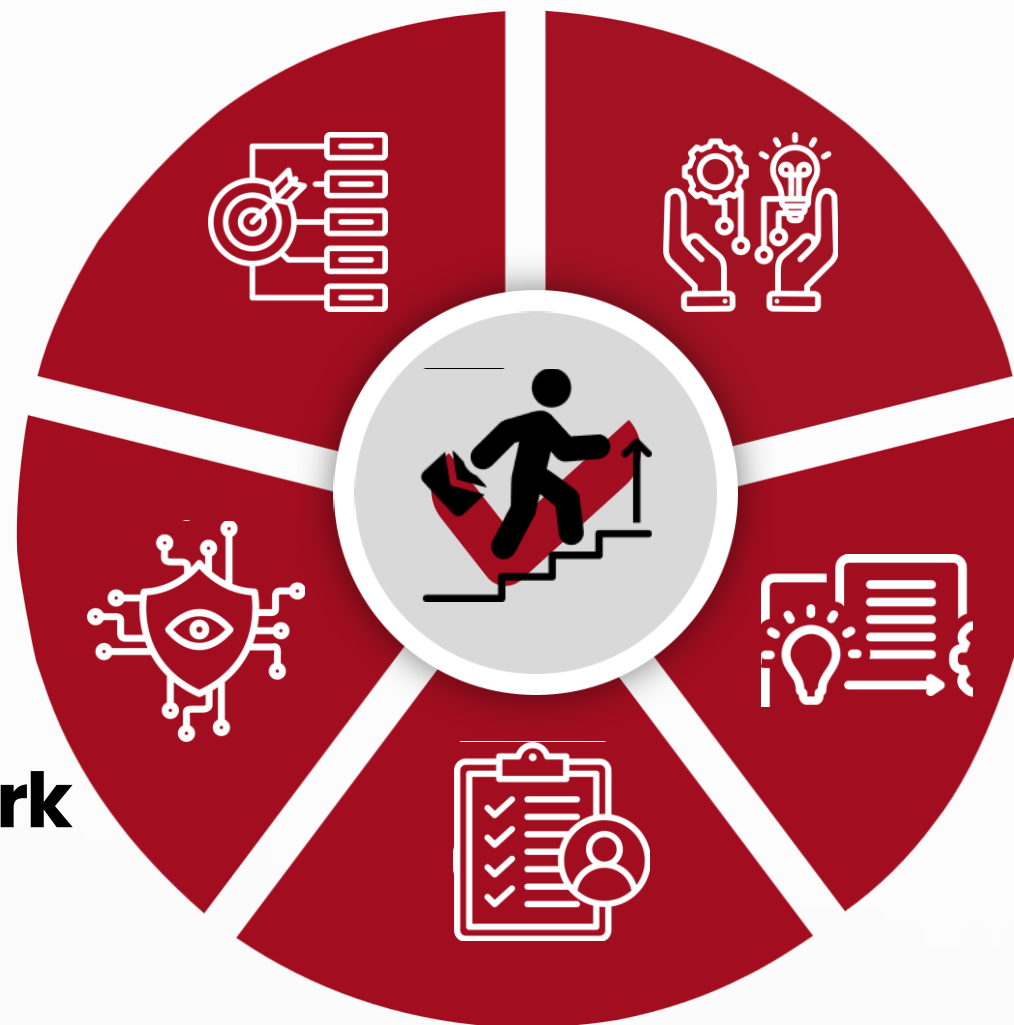

**Intumescent Paint**



**Cementitious Paint**



# Work Images



# STRUCTURAL ACTIVITIES

## Concrete



# STRUCTURAL ACTIVITIES

## Concrete Repair & Corrosion Protection



# STRUCTURAL ACTIVITIES

## Concrete Jacketing



# STRUCTURAL ACTIVITIES

## Injection Work

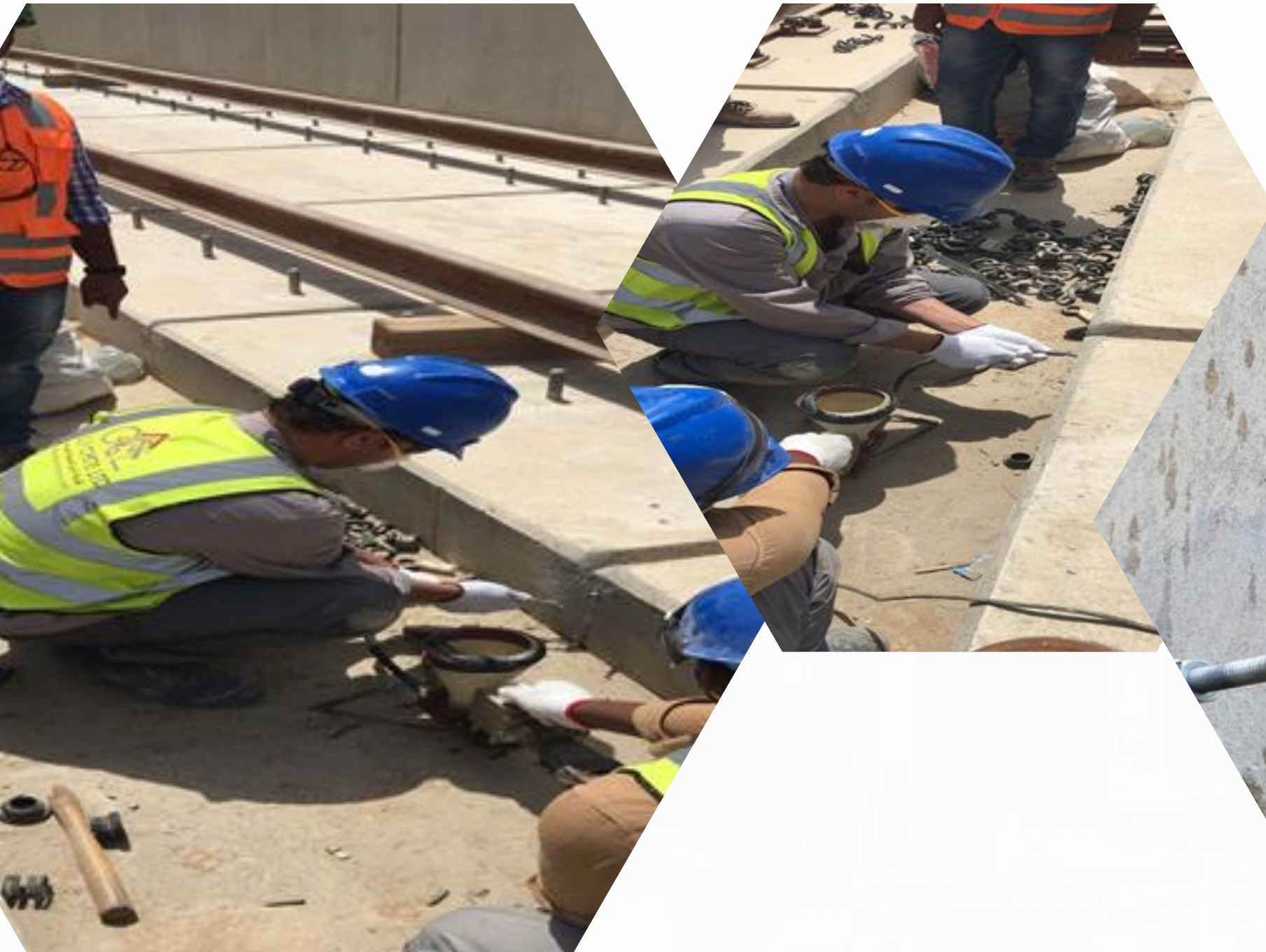

# STRUCTURAL ACTIVITIES

## Cathodic Protection





# STRUCTURAL ACTIVITIES

## CFRP

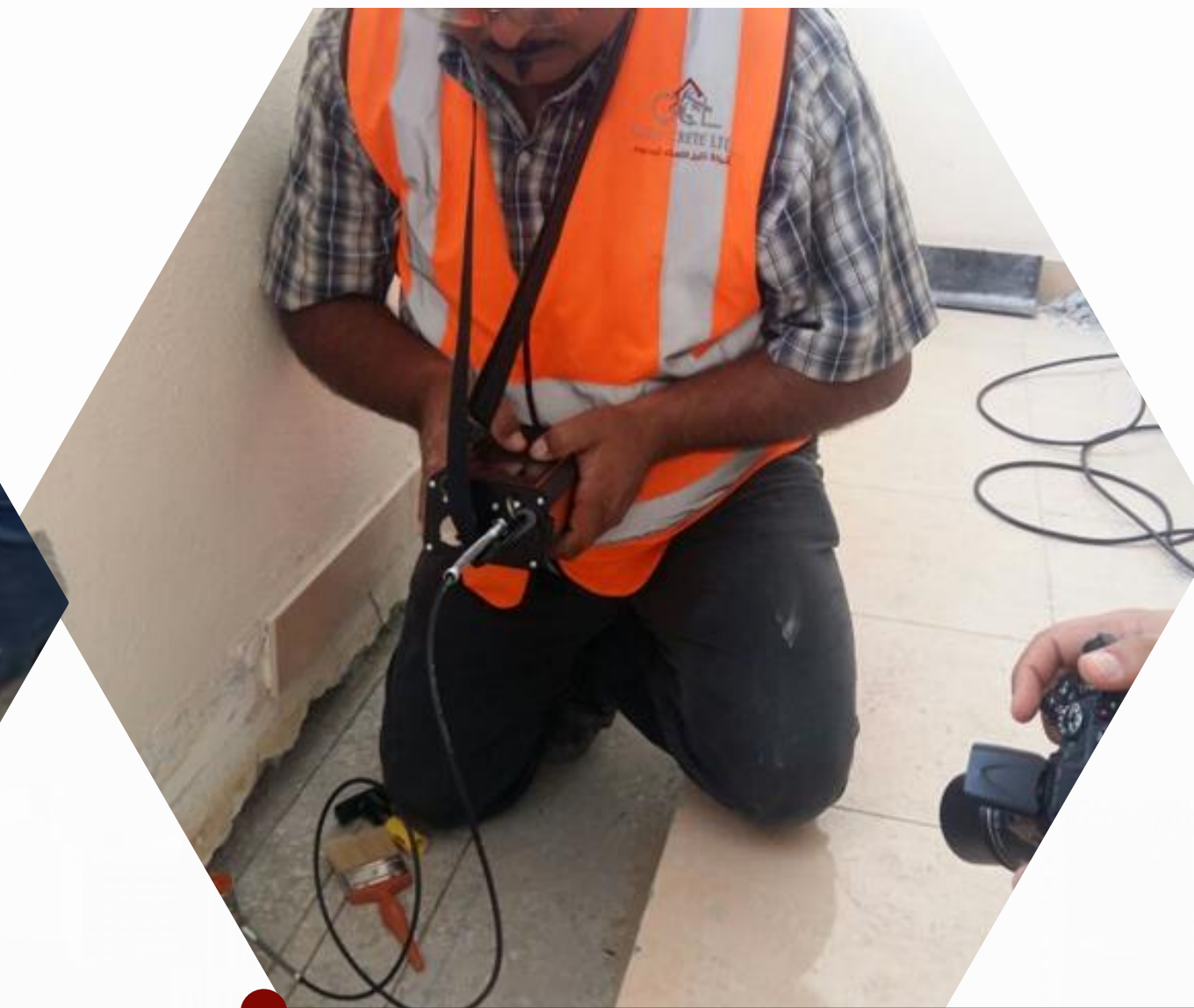

# STRUCTURAL ACTIVITIES

## CFRP

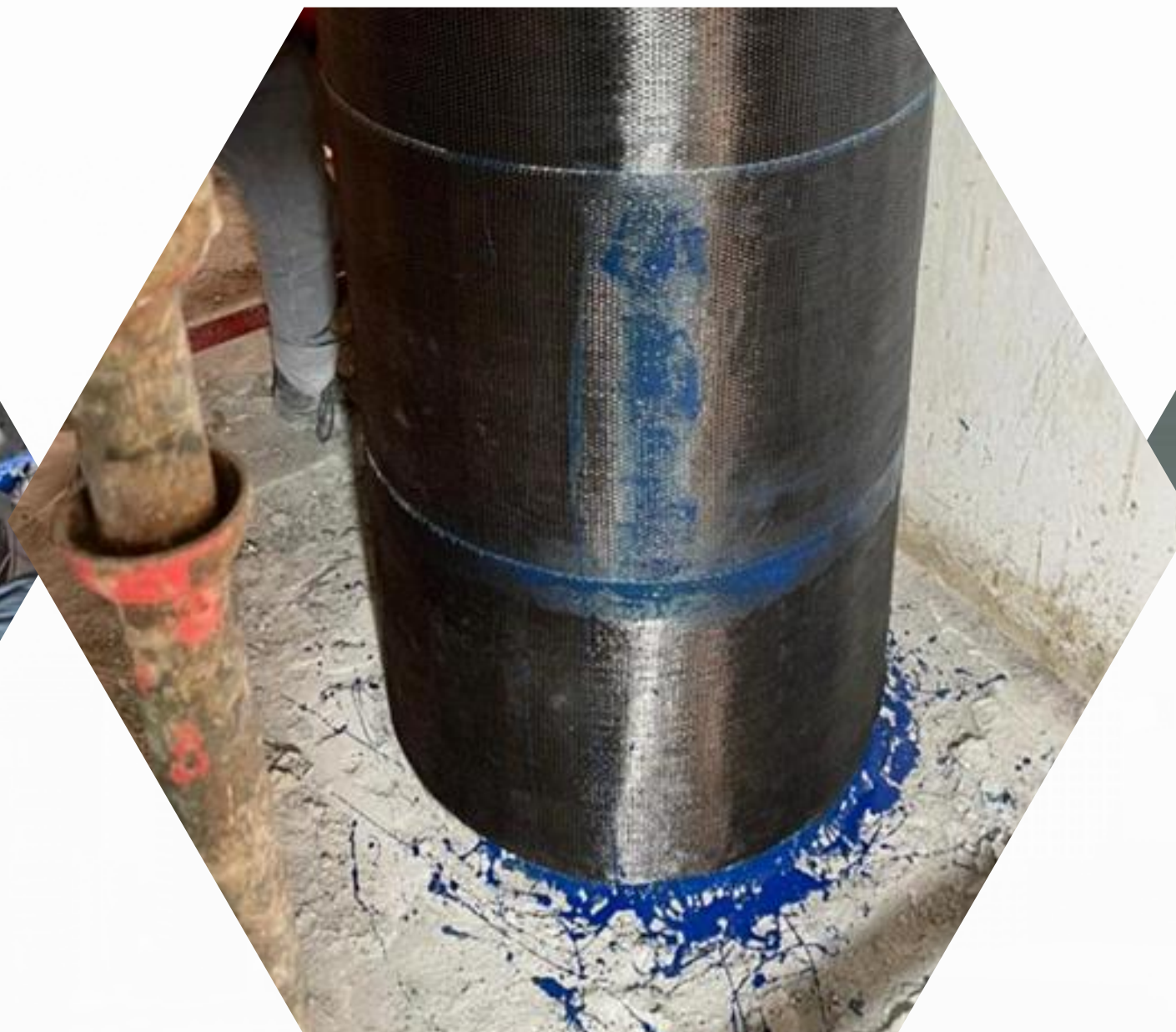

# STRUCTURAL ACTIVITIES

## 3D CONSTRUCTION SYSTEM

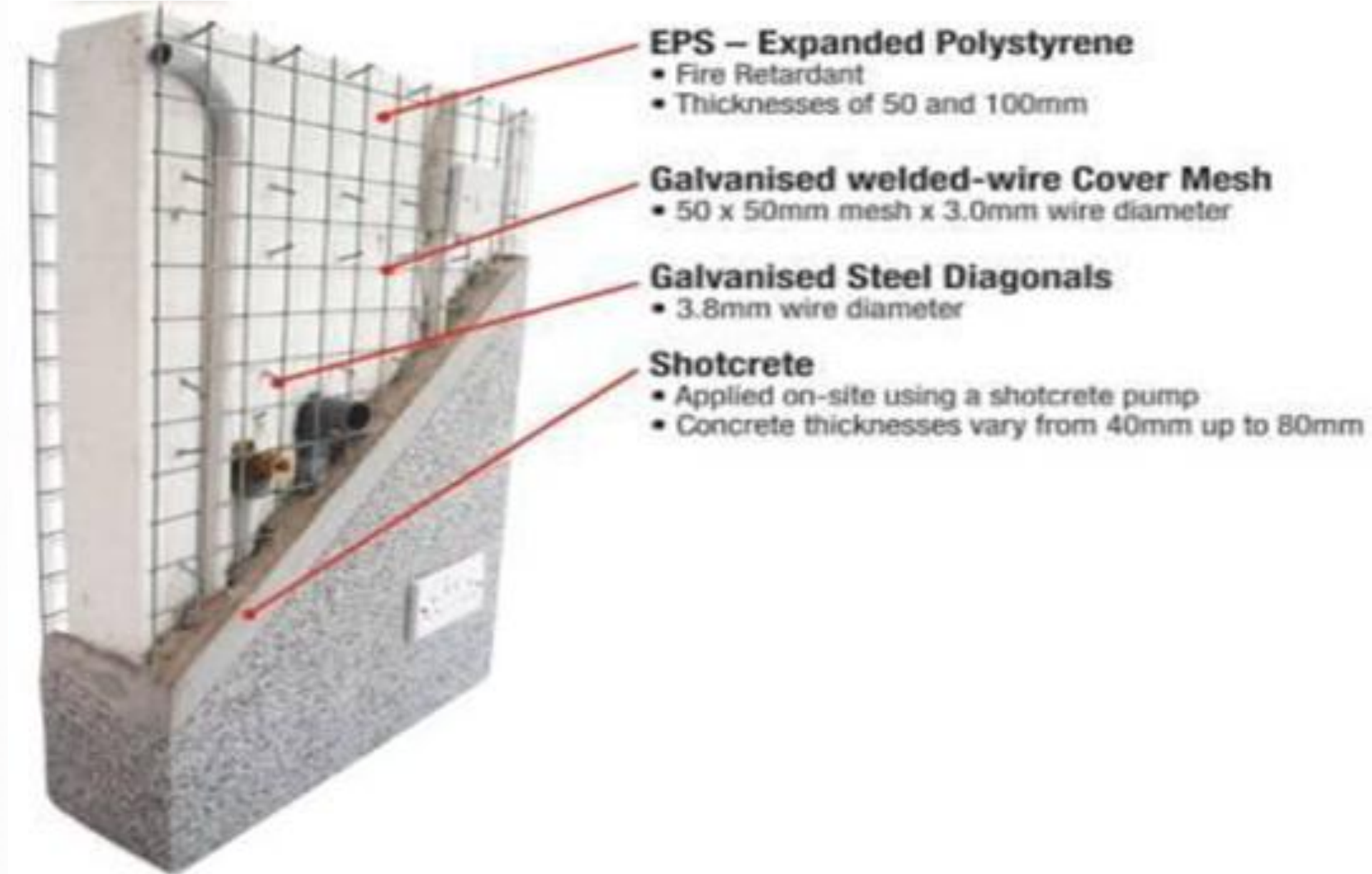

# STRUCTURAL ACTIVITIES

## 3D CONSTRUCTION SYSTEM

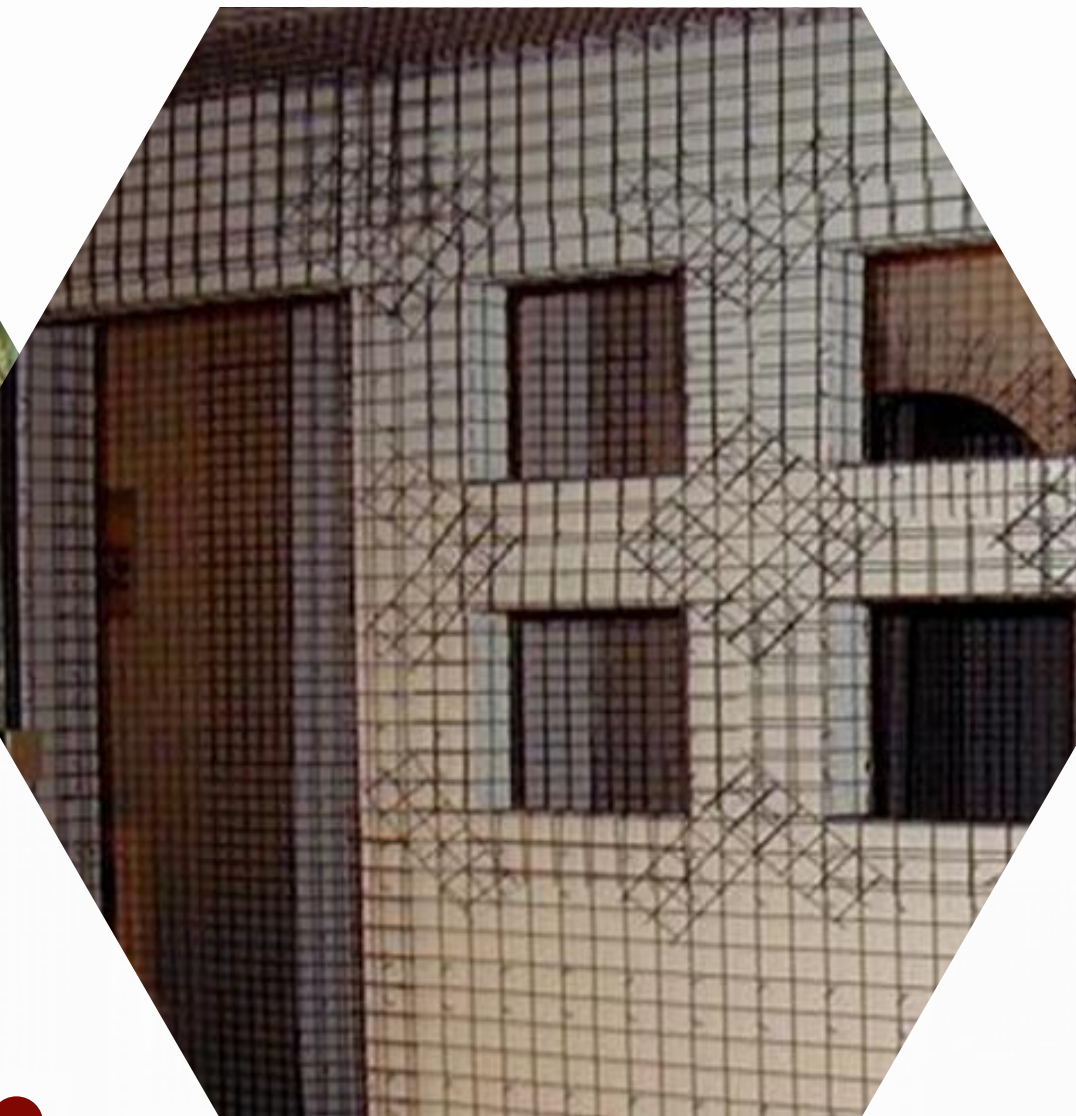
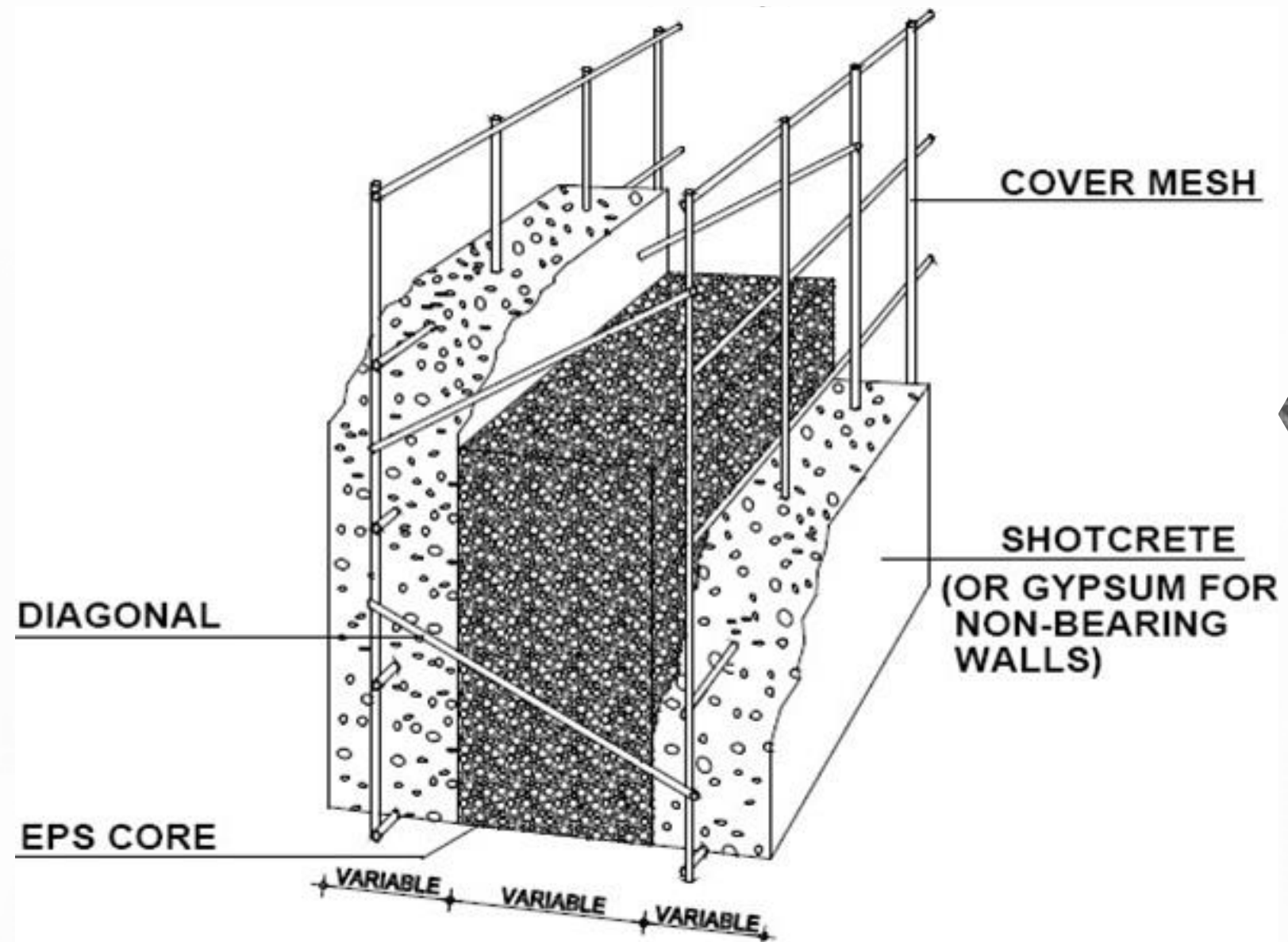

# STRUCTURAL ACTIVITIES

## Soil Injection



# STRUCTURAL ACTIVITIES

## Soil Injection



# STRUCTURAL ACTIVITIES

## Soil Injection



# STRUCTURAL ACTIVITIES

## Rock Bolts





# STRUCTURAL ACTIVITIES

## Rock Bolts



# STRUCTURAL ACTIVITIES

## ShotCrete



# STRUCTURAL ACTIVITIES

## ShotCrete

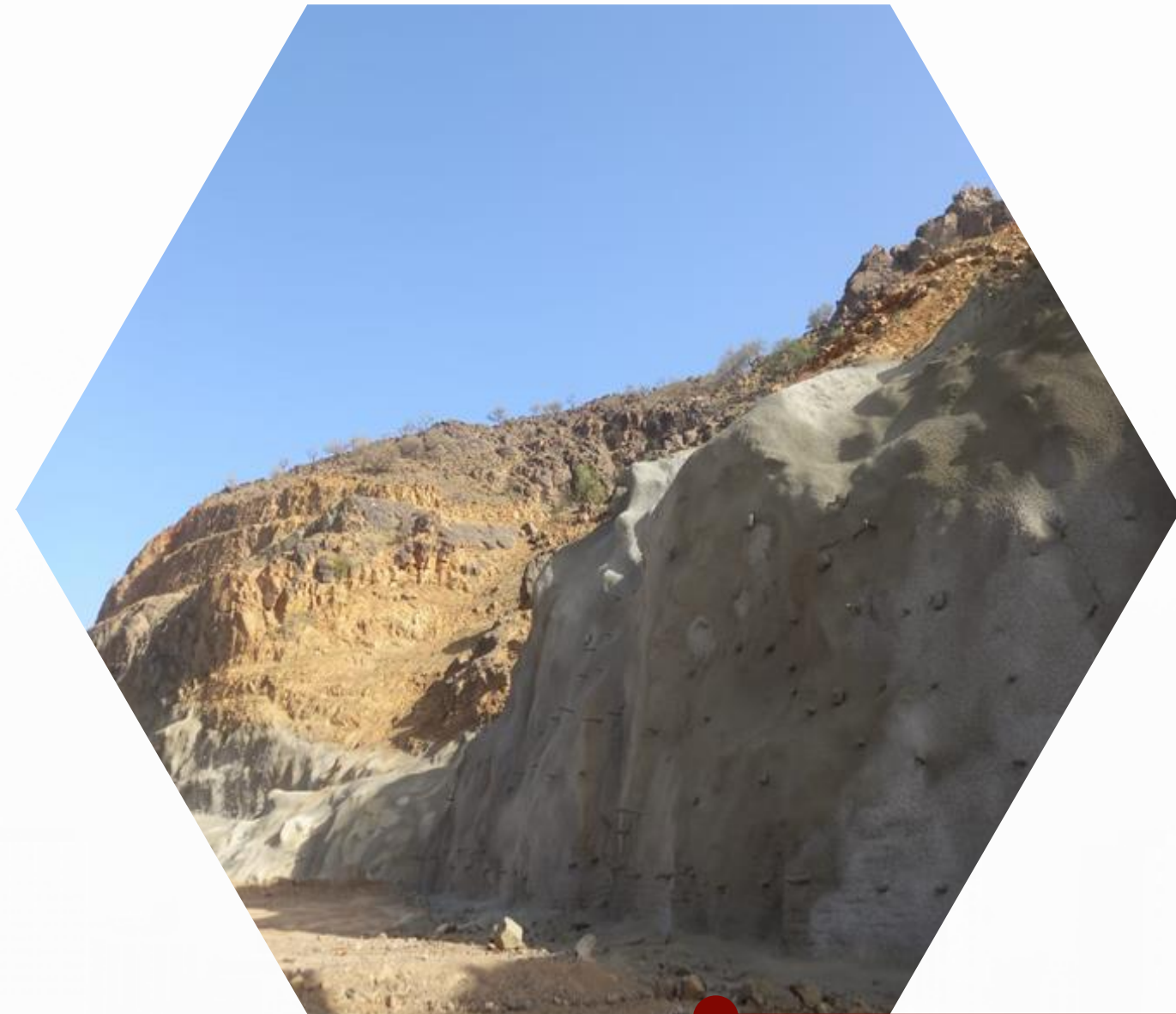
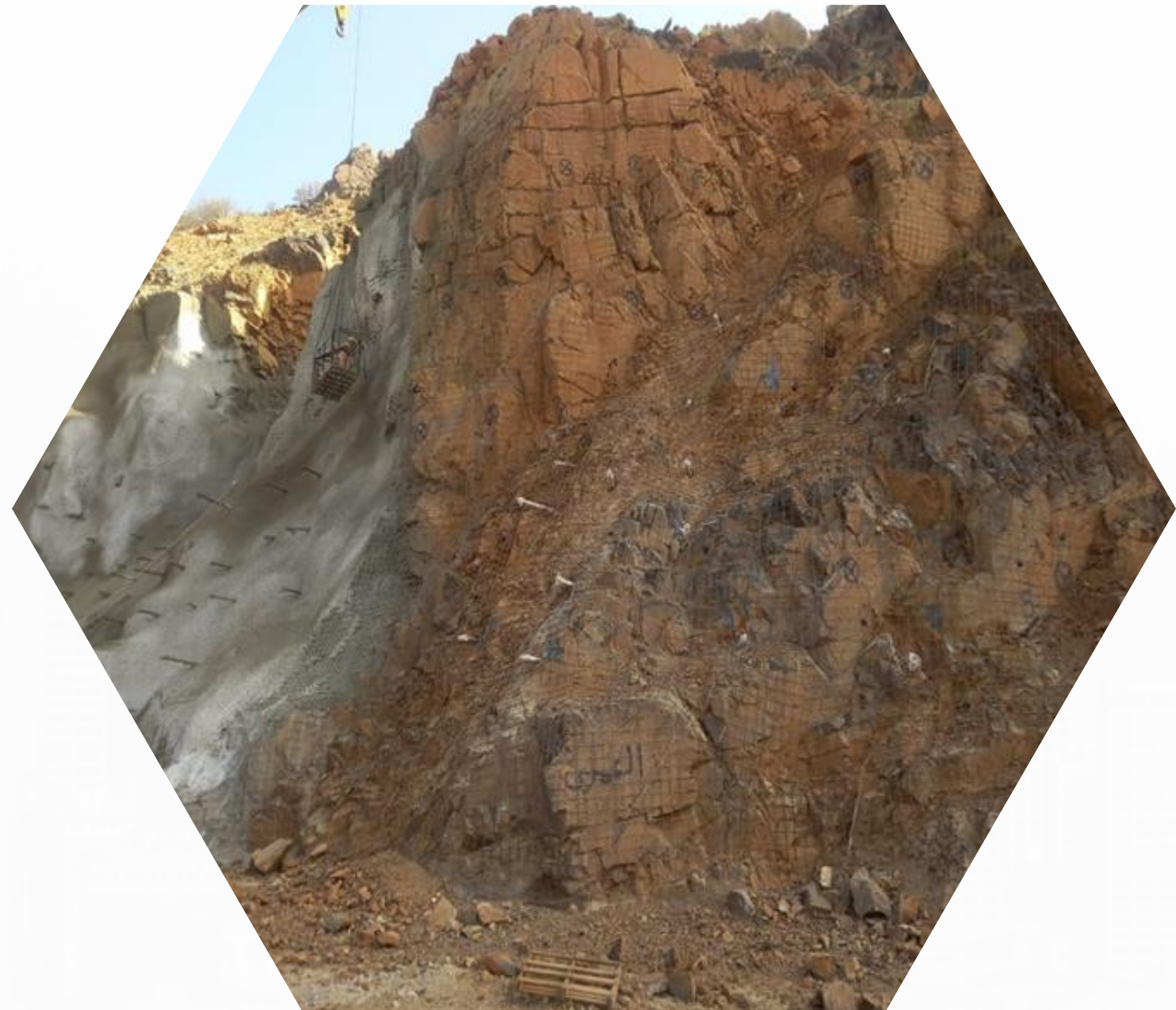

# STRUCTURAL ACTIVITIES

## Micro Piles

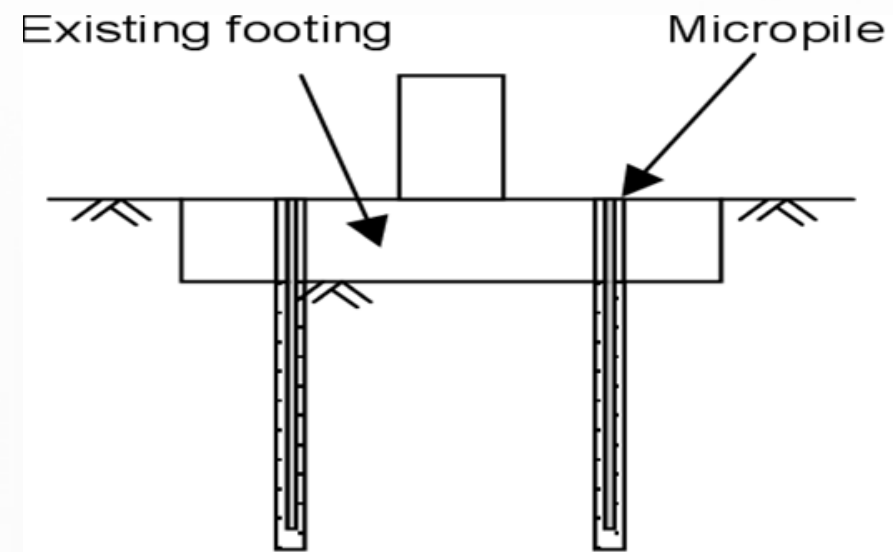

Micropiles through existing footing

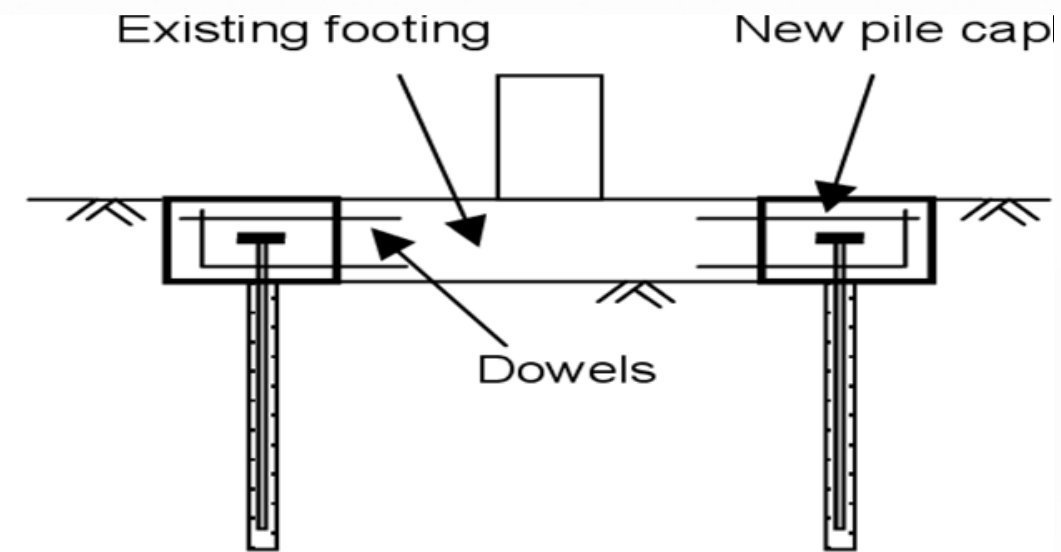

New pile cap attached to existing footing

# RockFall Protection

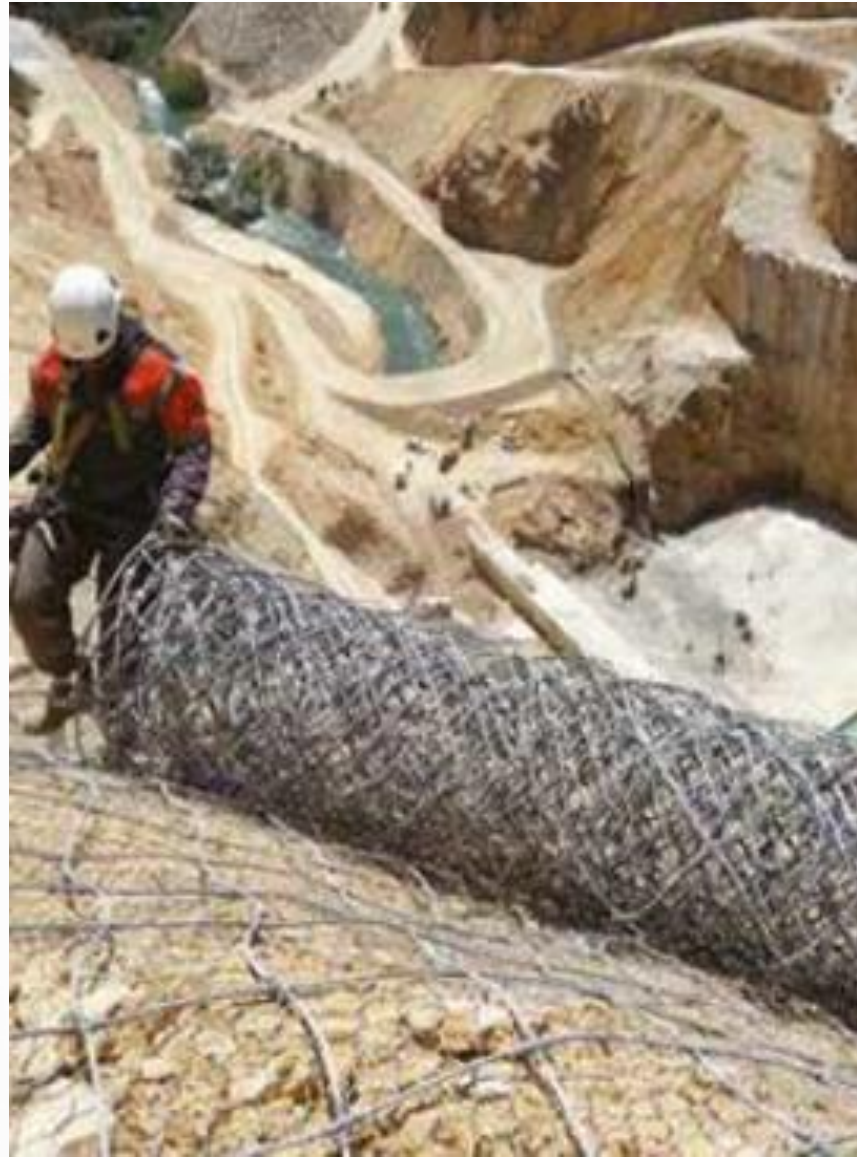

# RockFall Protection



# RockFall Protection

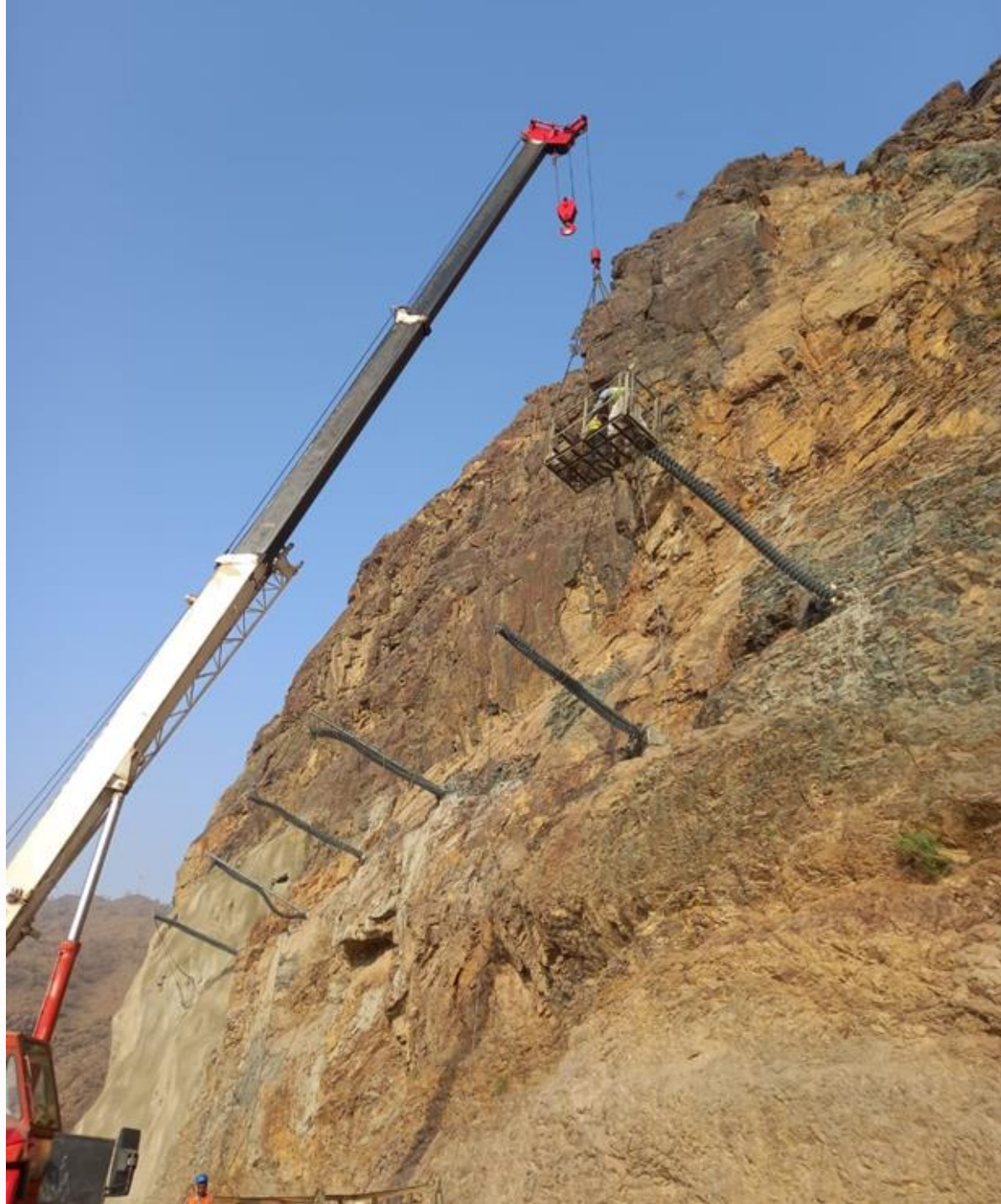

# RockFall Protection

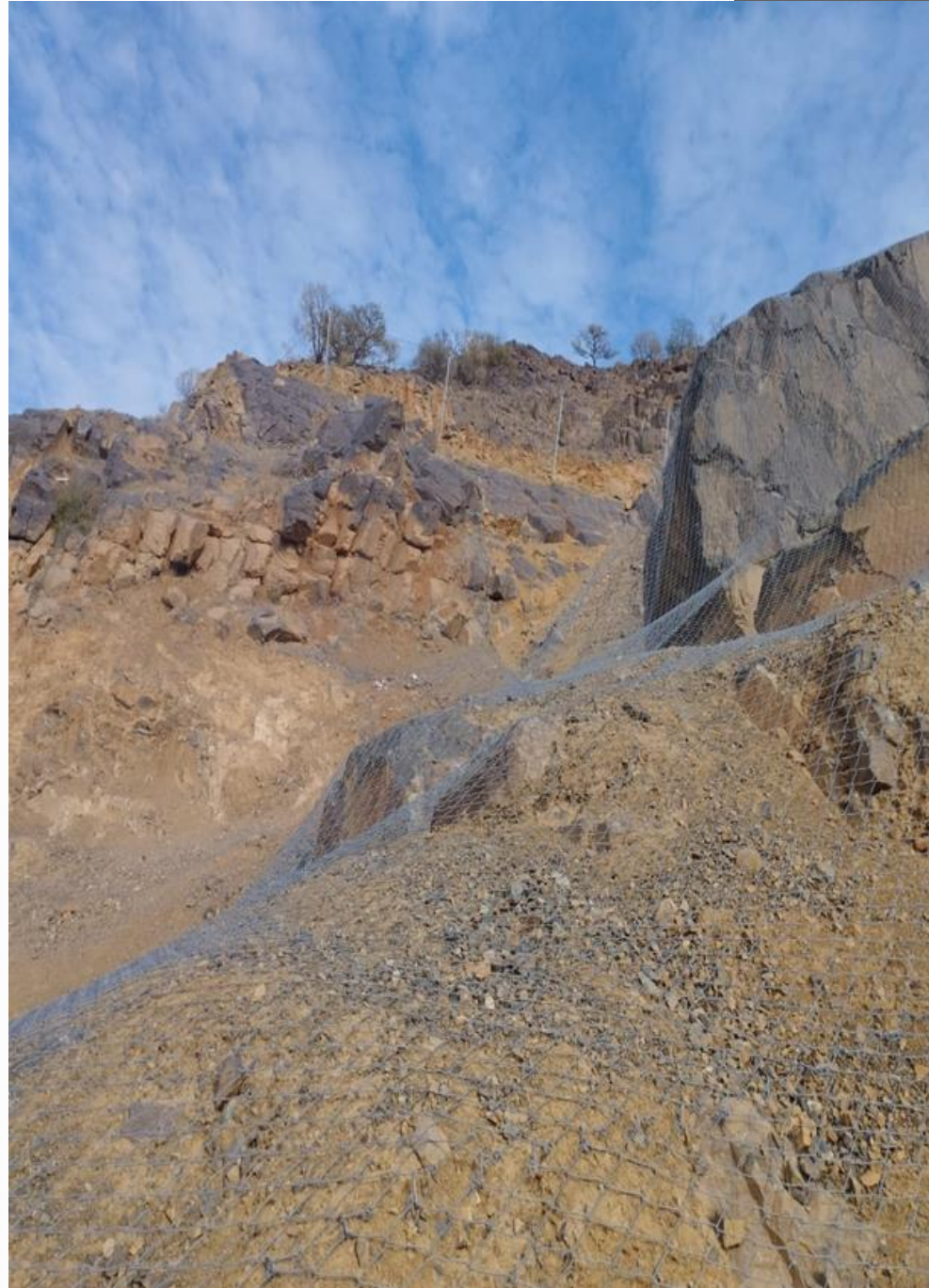



# RockFall Protection

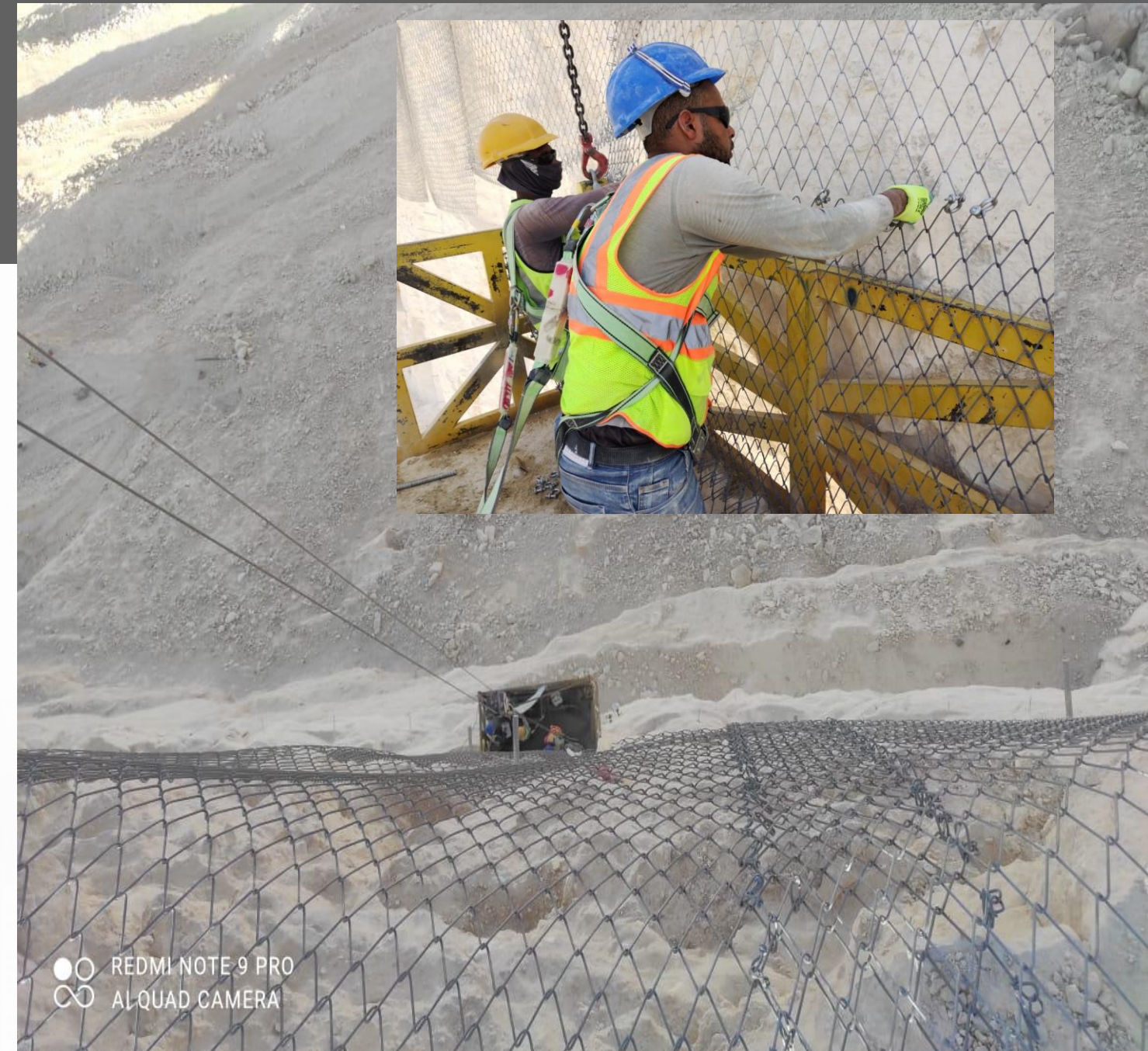
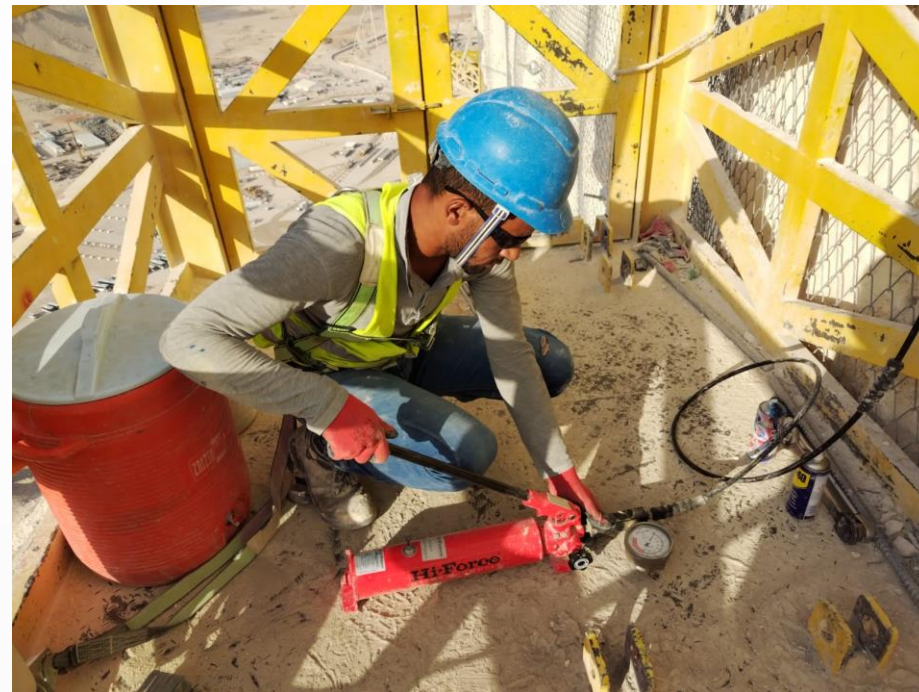

# Survey Technology

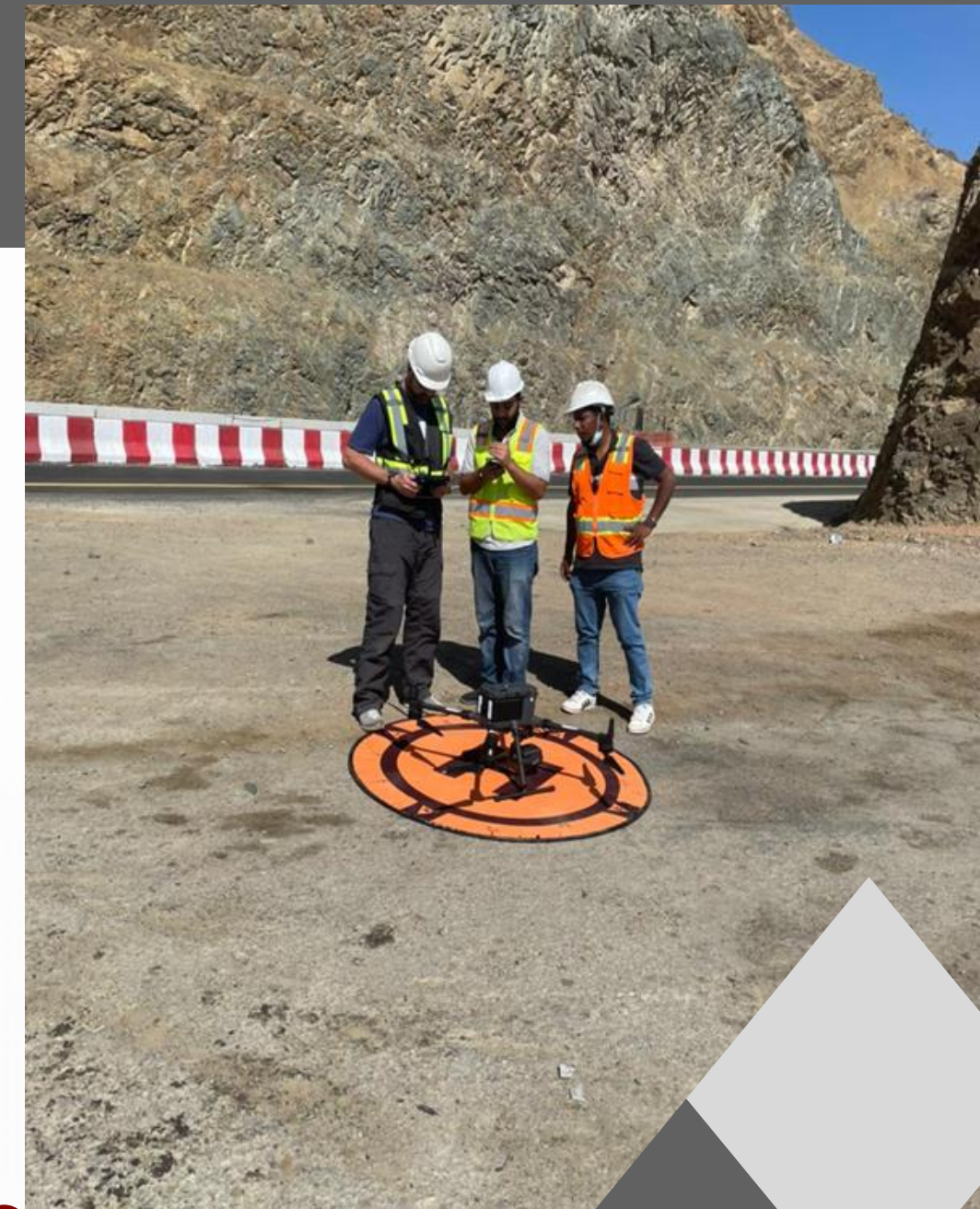

# Survey Technology

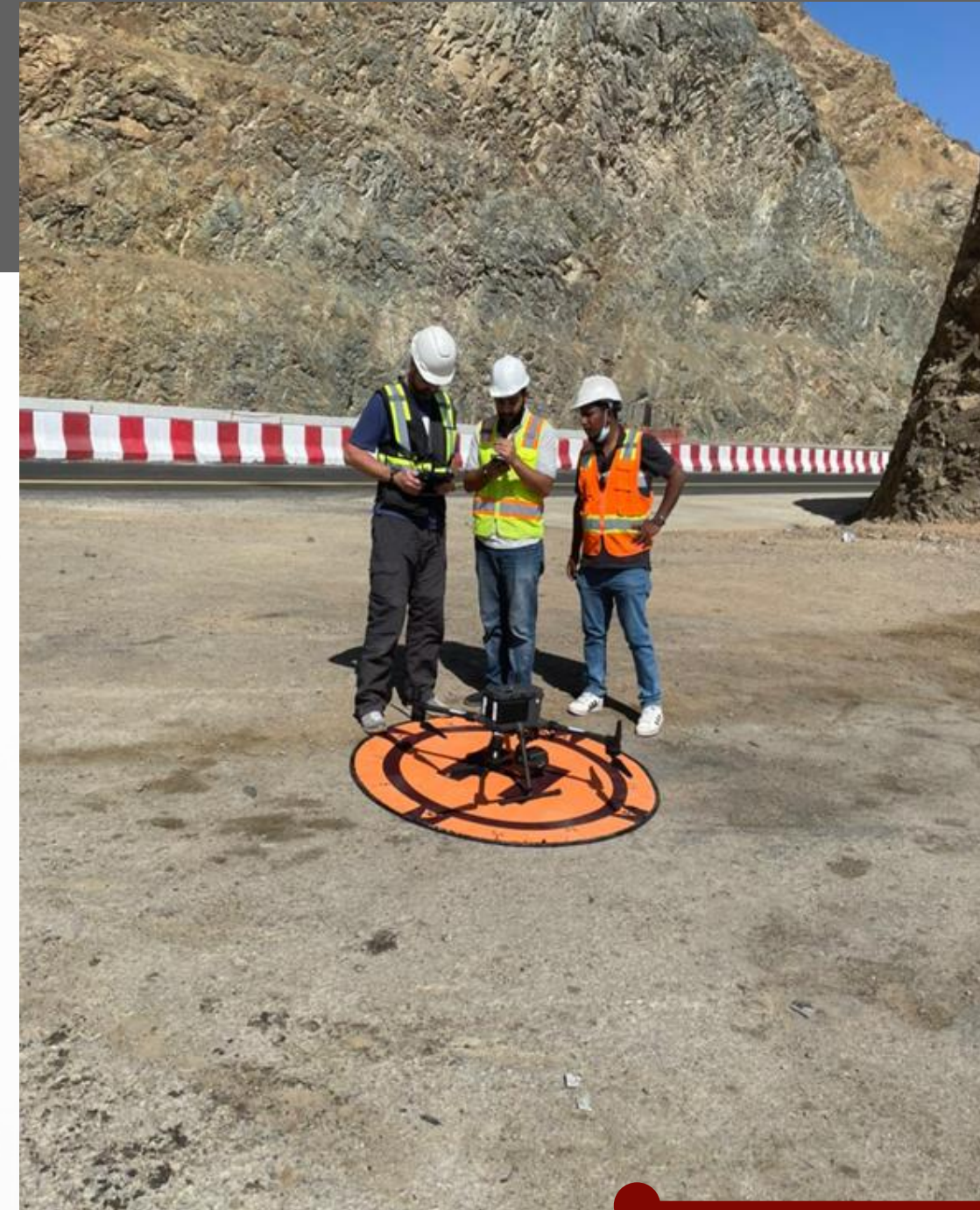
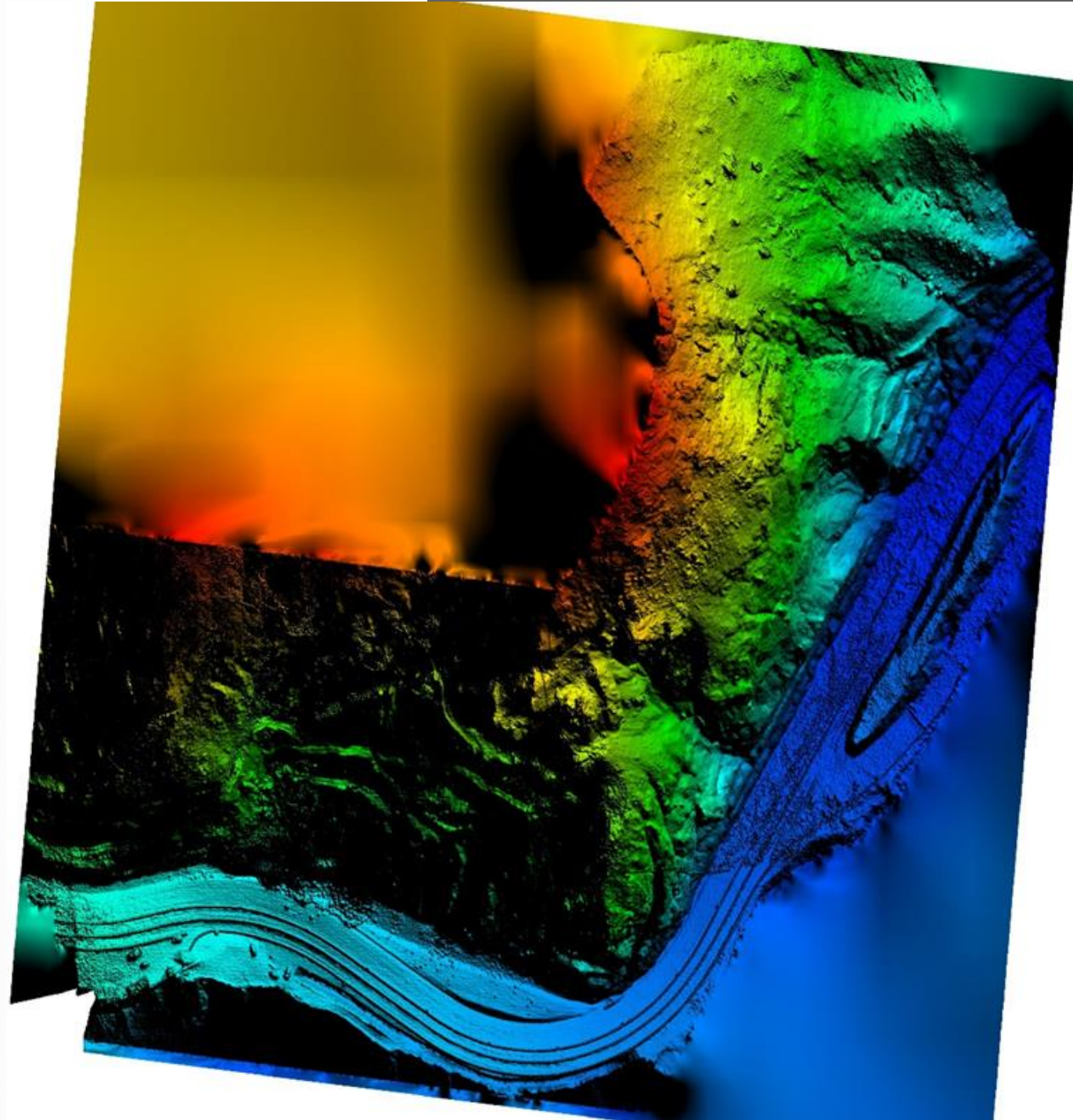

# Survey Technology

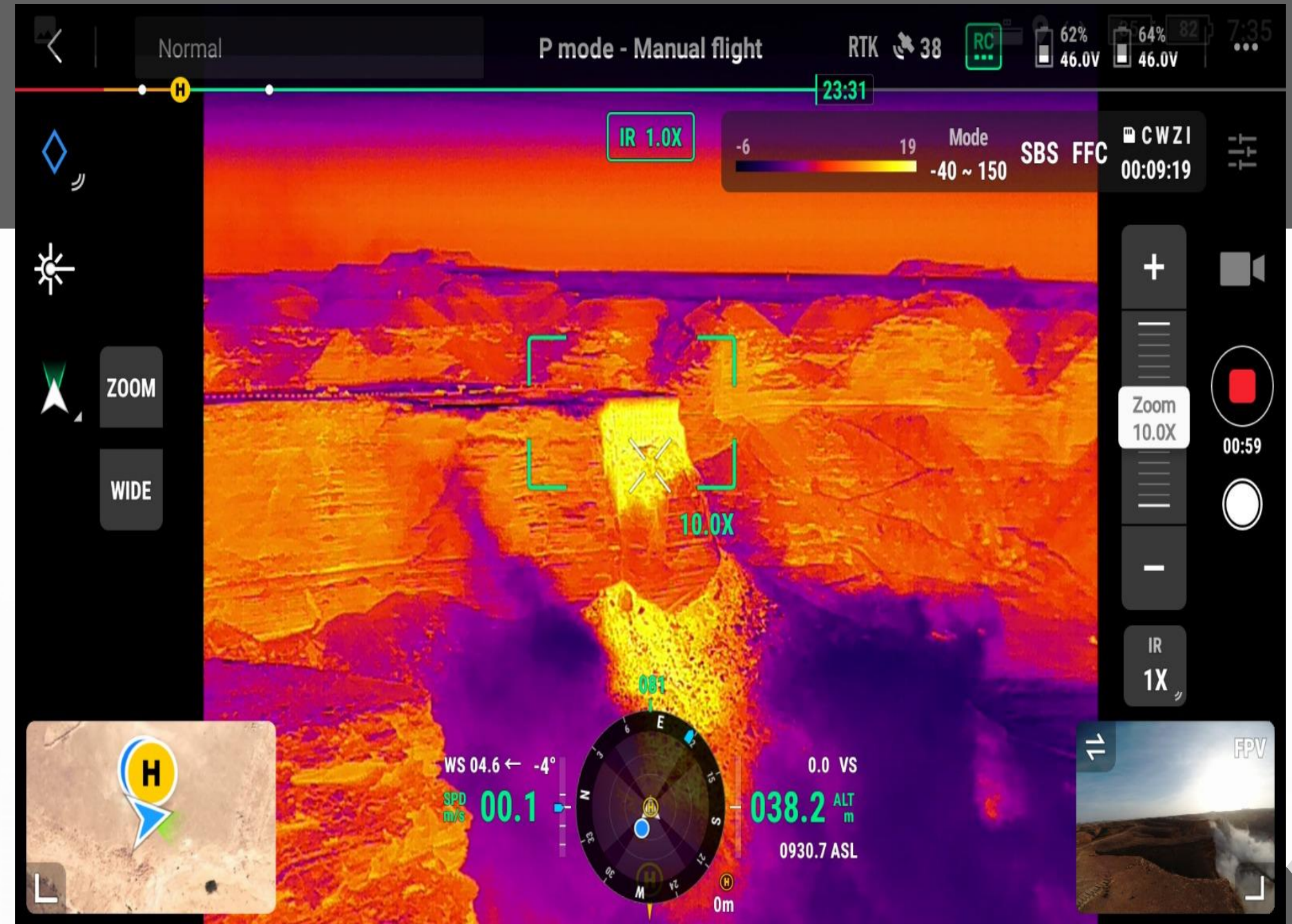
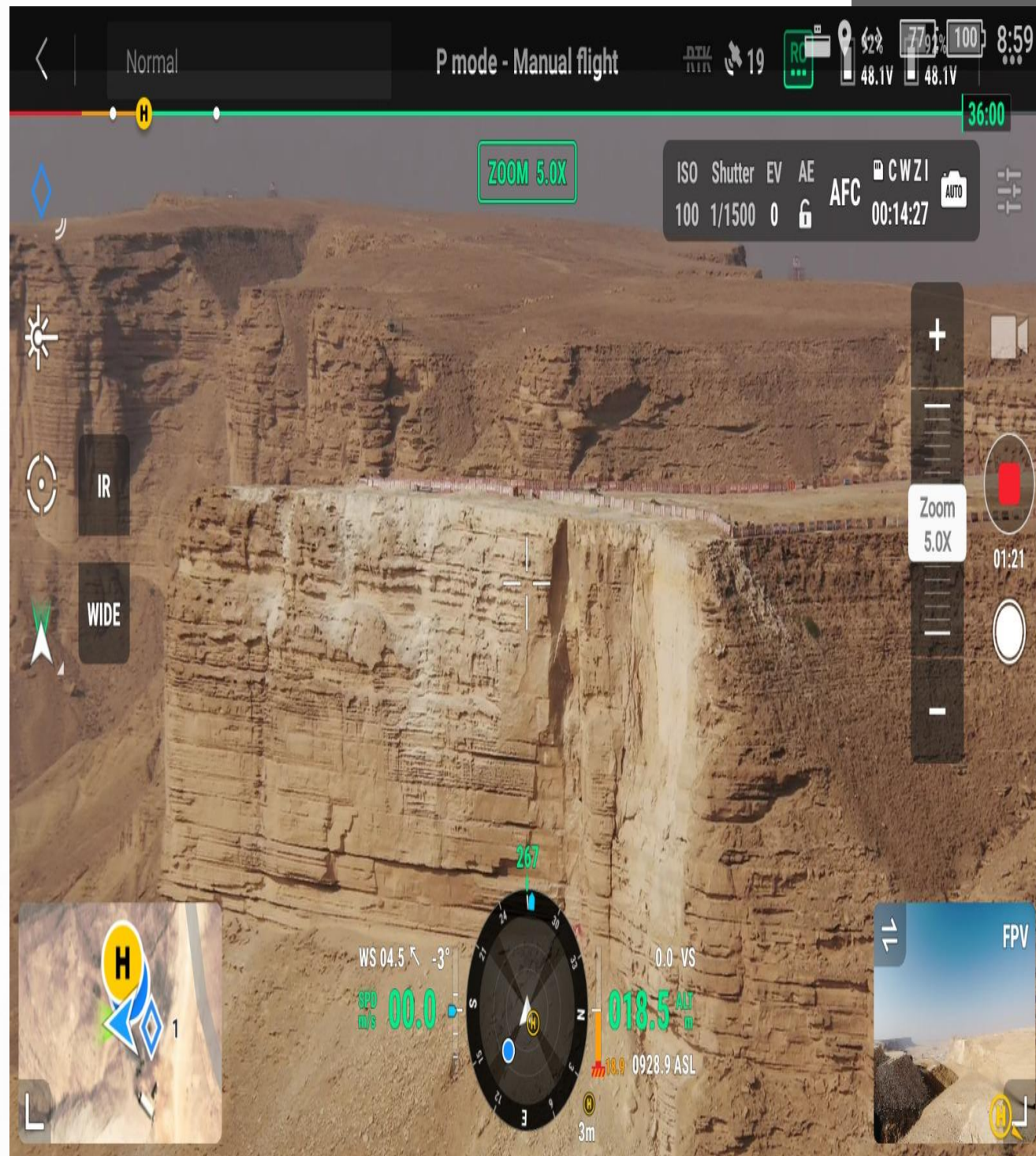

# INDUSTRIAL FLOORING & COATING ACTIVITIES

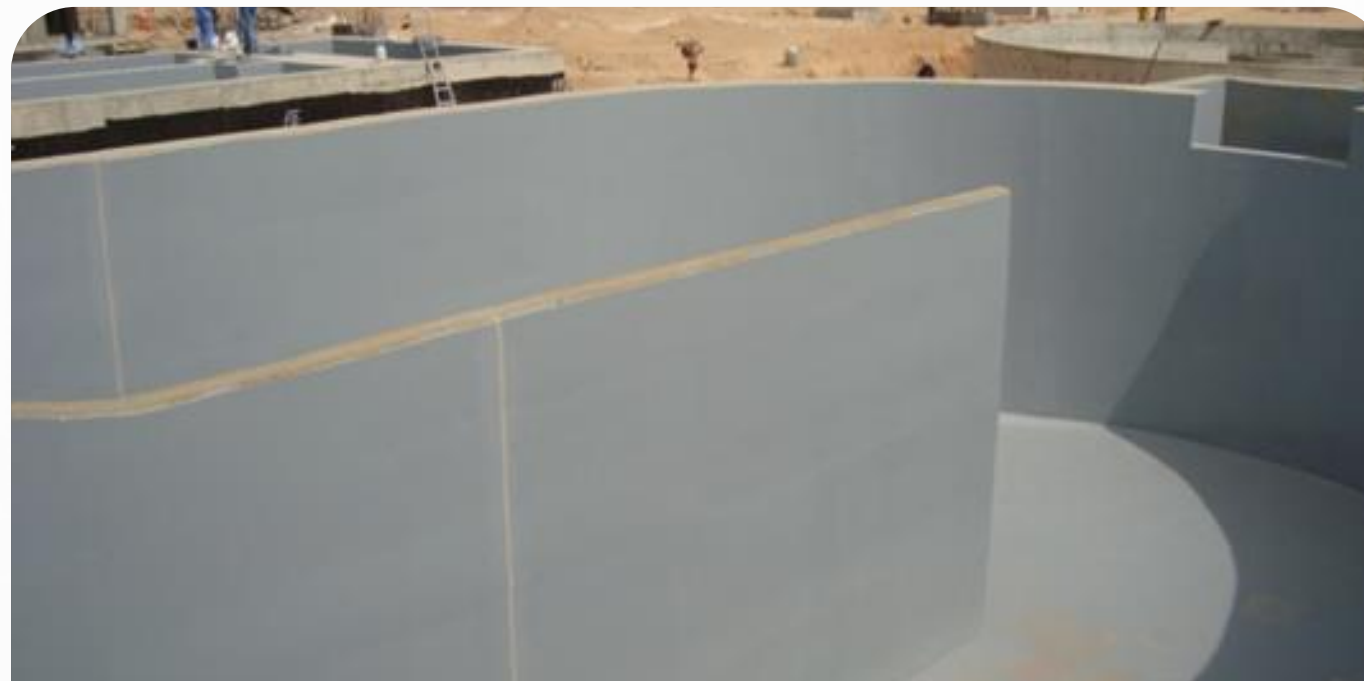

# INDUSTRIAL FLOORING

## Polyurethane and polyurea Coating

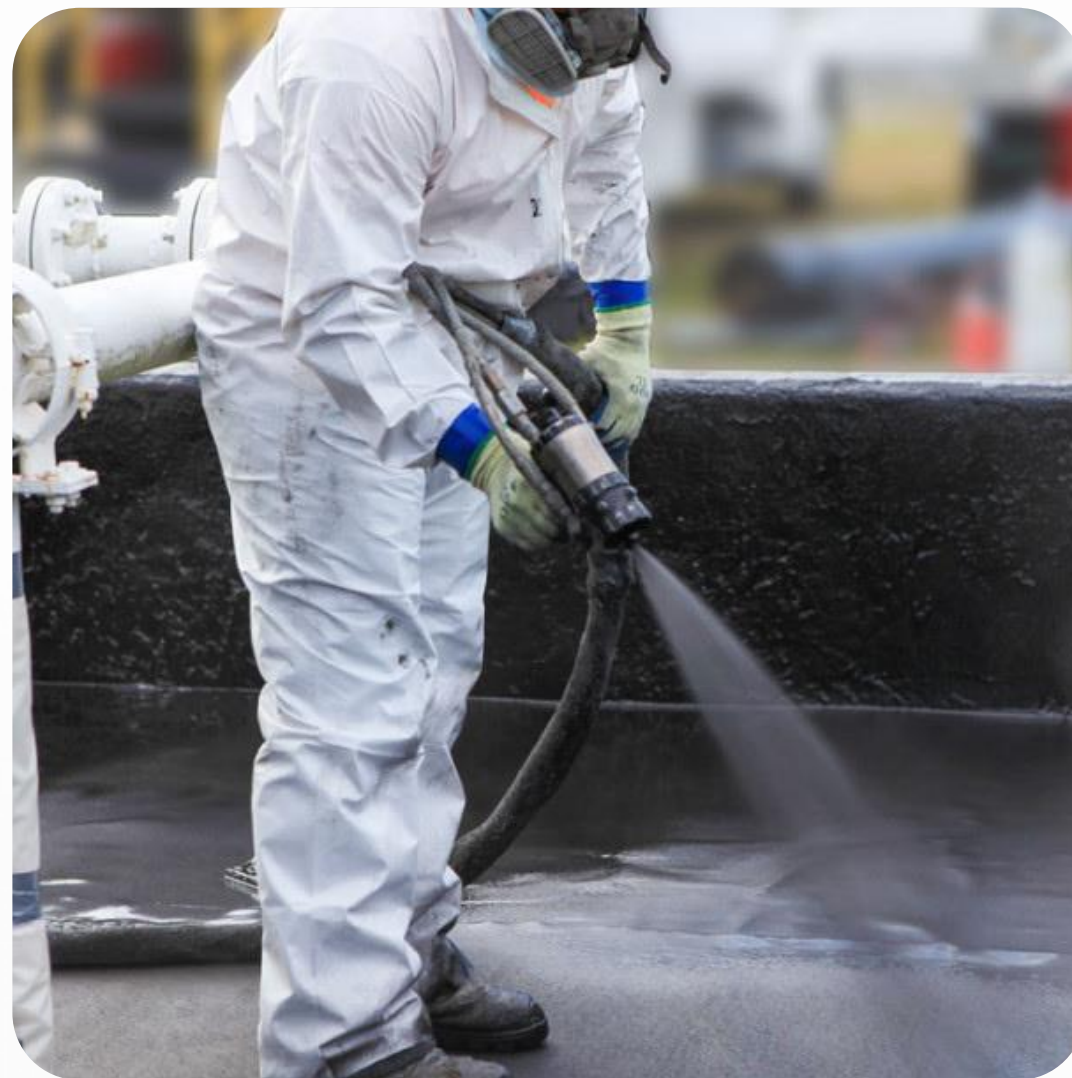

# INDUSTRIAL FLOORING

## Polyurethane and polyurea Coating



# INDUSTRIAL FLOORING

## Epoxy Terrazzo Finishing





# INDUSTRIAL FLOORING

## Heavy Grinding for Floor Concrete

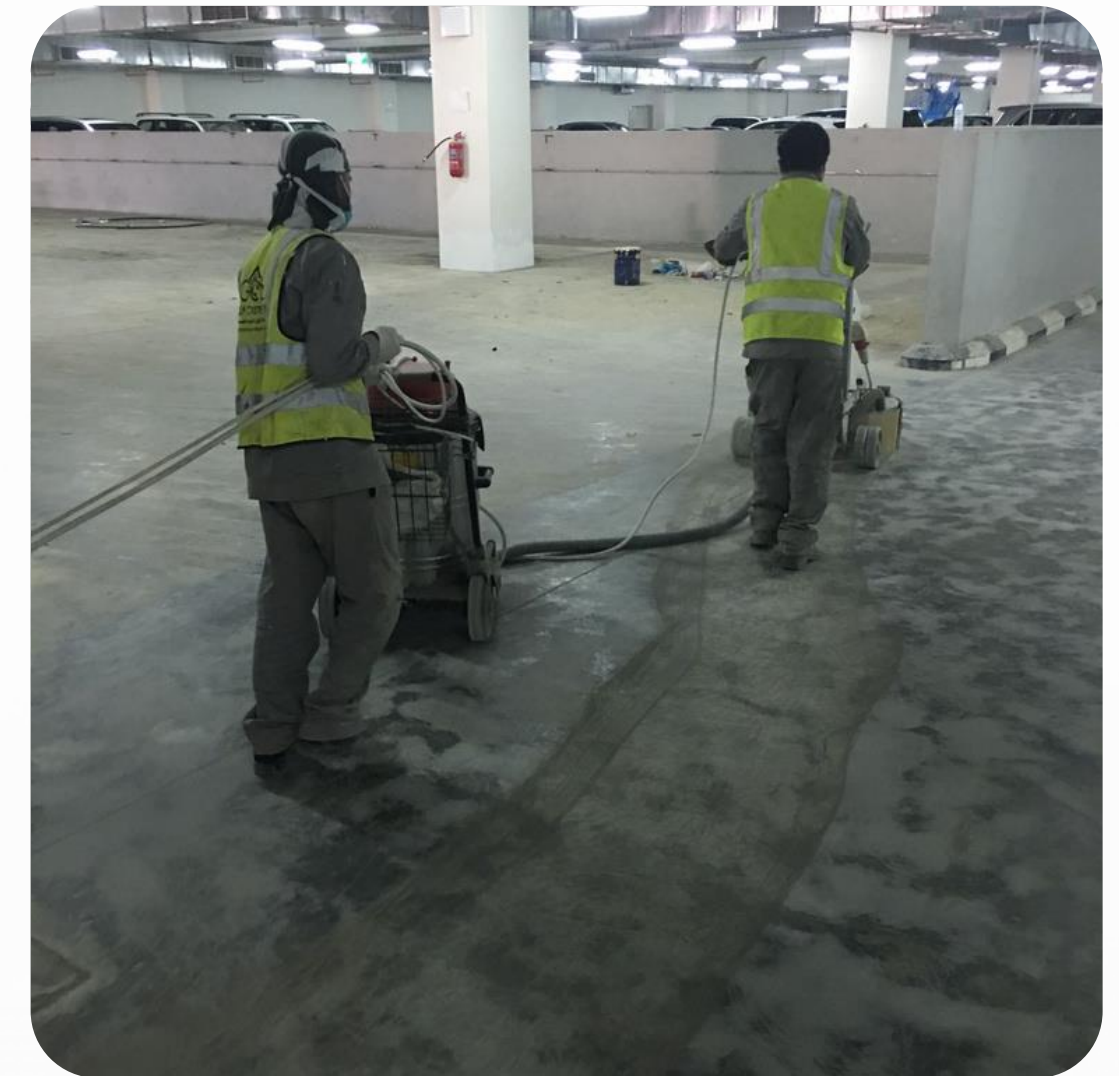
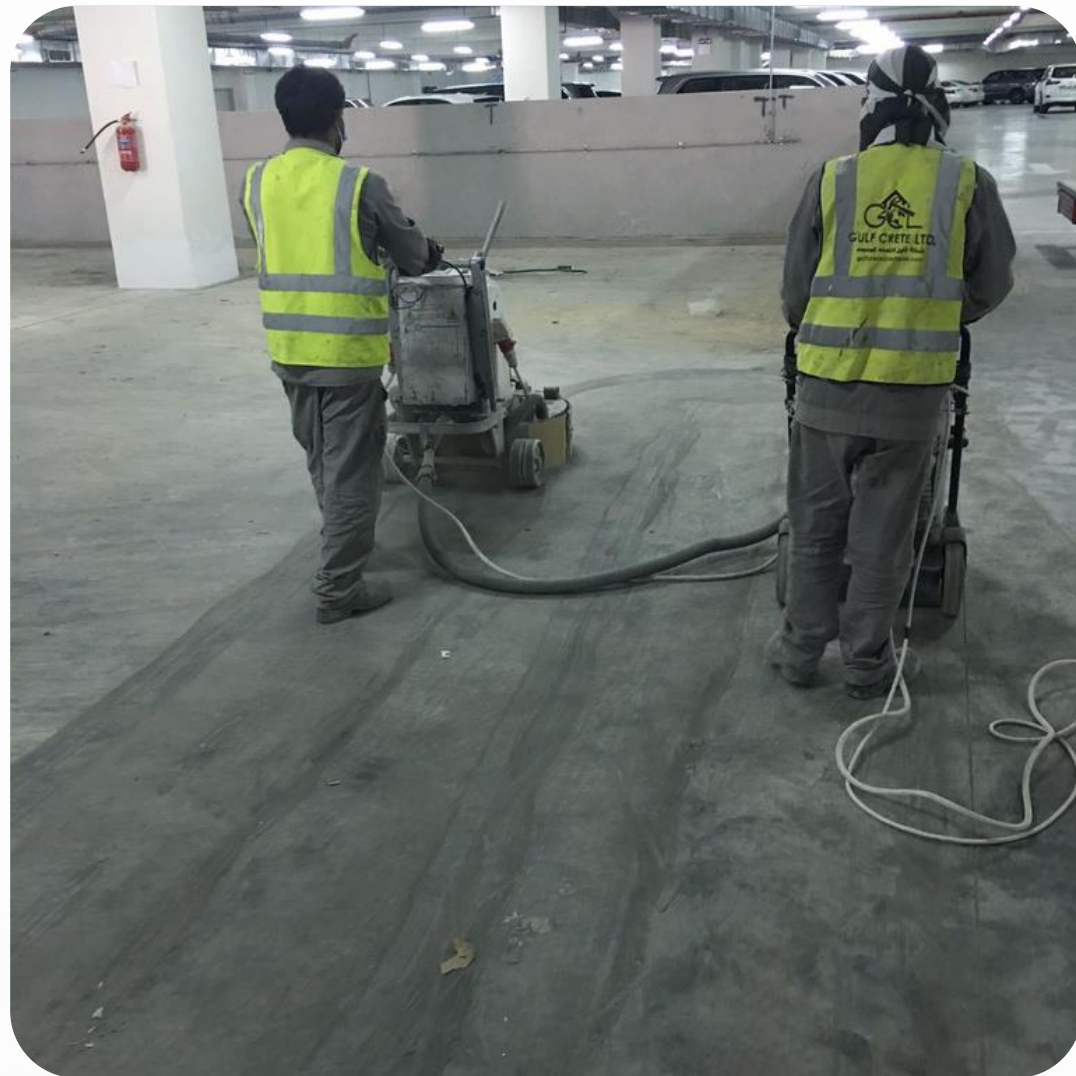

# INDUSTRIAL FLOORING

## Screed Casting

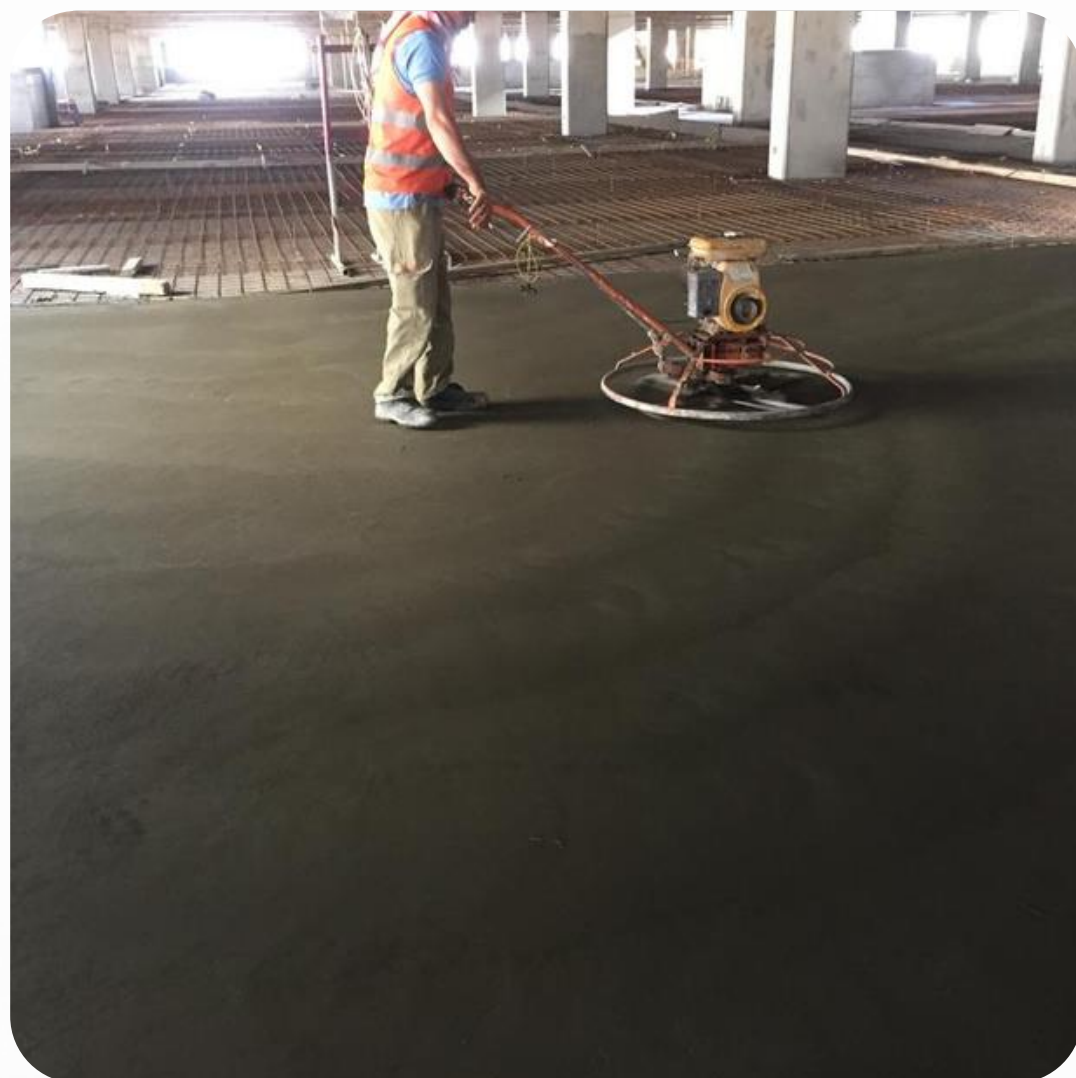

# INDUSTRIAL FLOORING

**Airport runways and helipads**

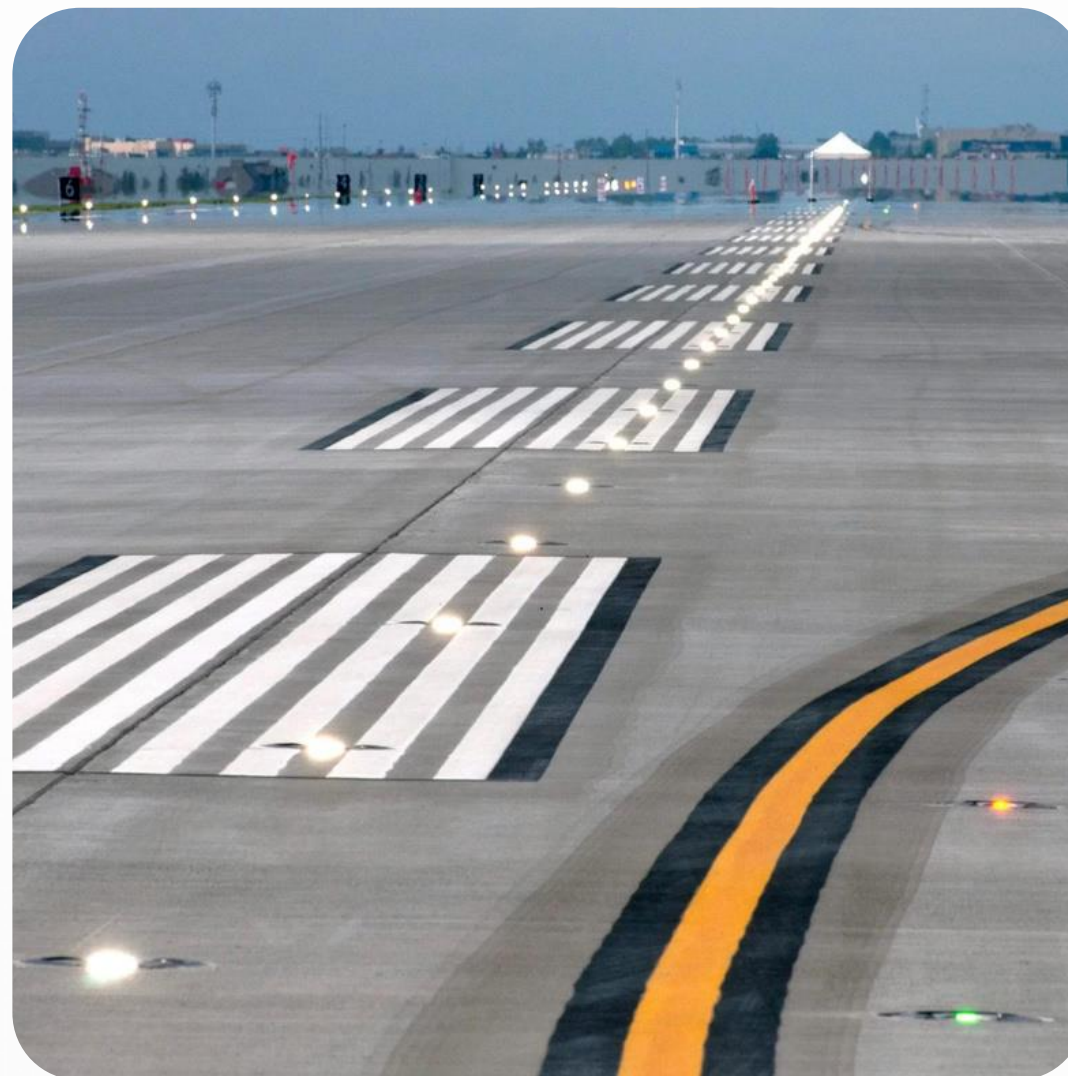

# INDUSTRIAL FLOORING

## Micro topping Flooring Coating

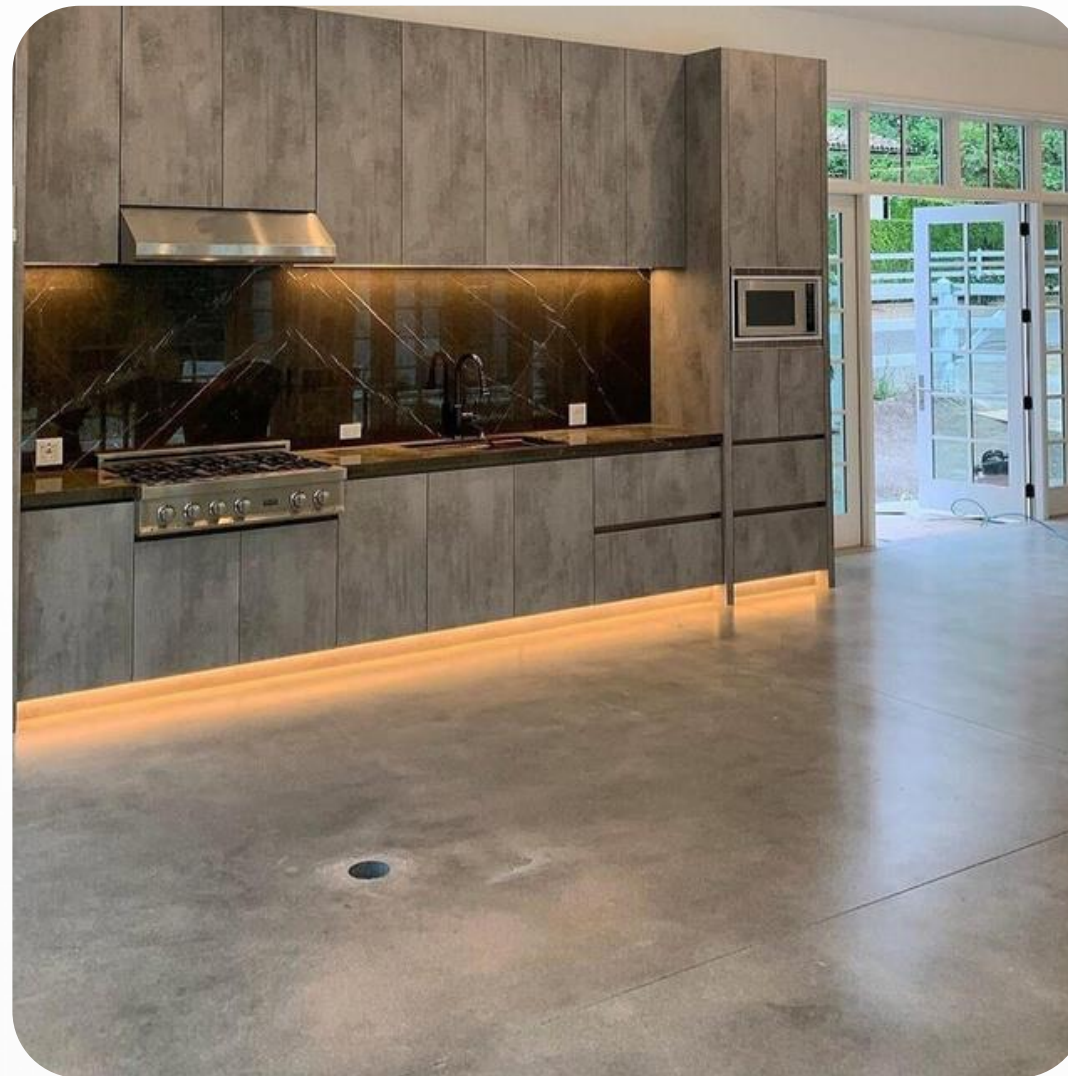

# INDUSTRIAL FLOORING

## Cementitious self leveling



# INDUSTRIAL FLOORING

## Anti-Static Flooring

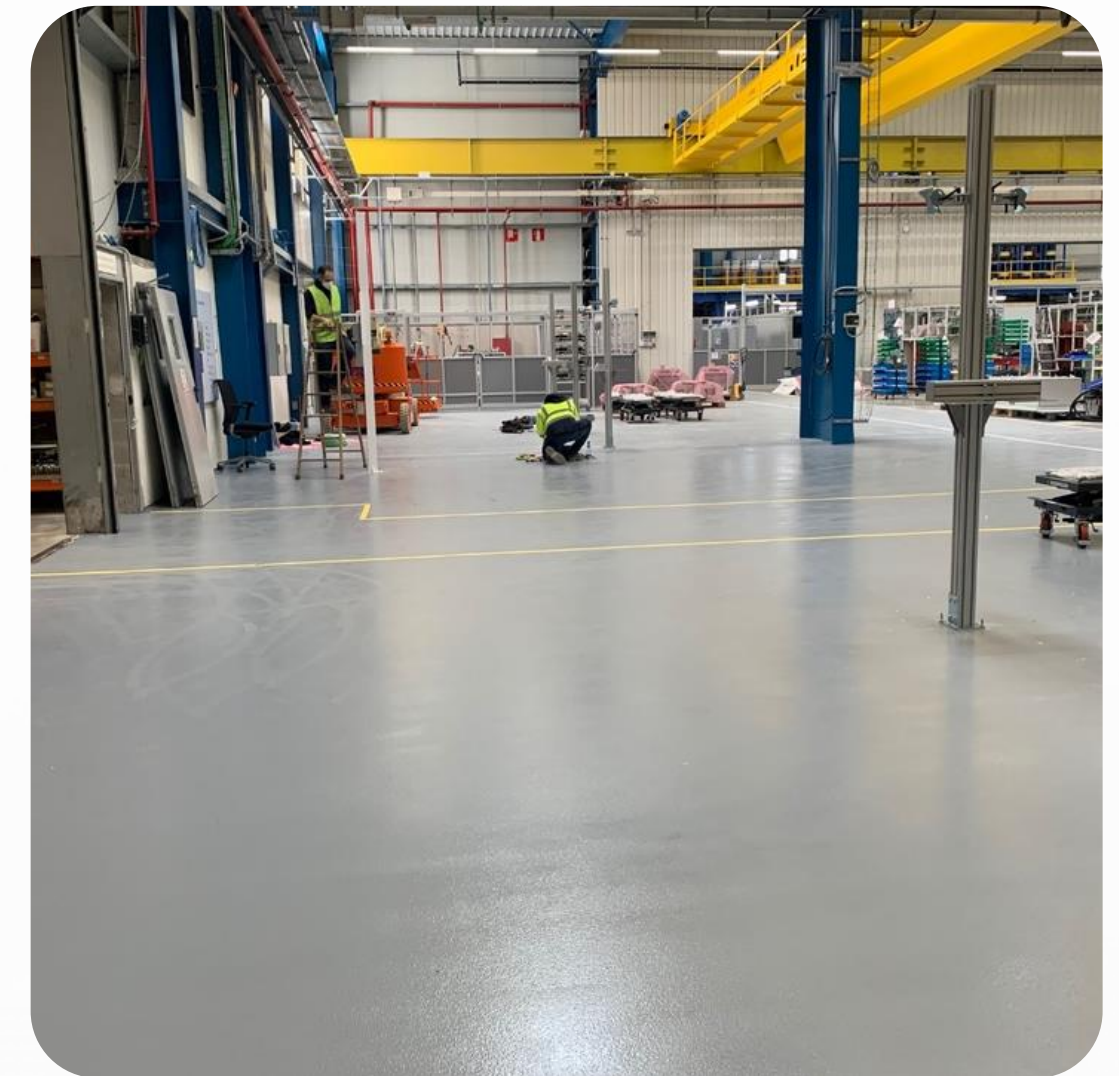

# INDUSTRIAL FLOORING

## Polyurethane Screed (such as U-Crete)

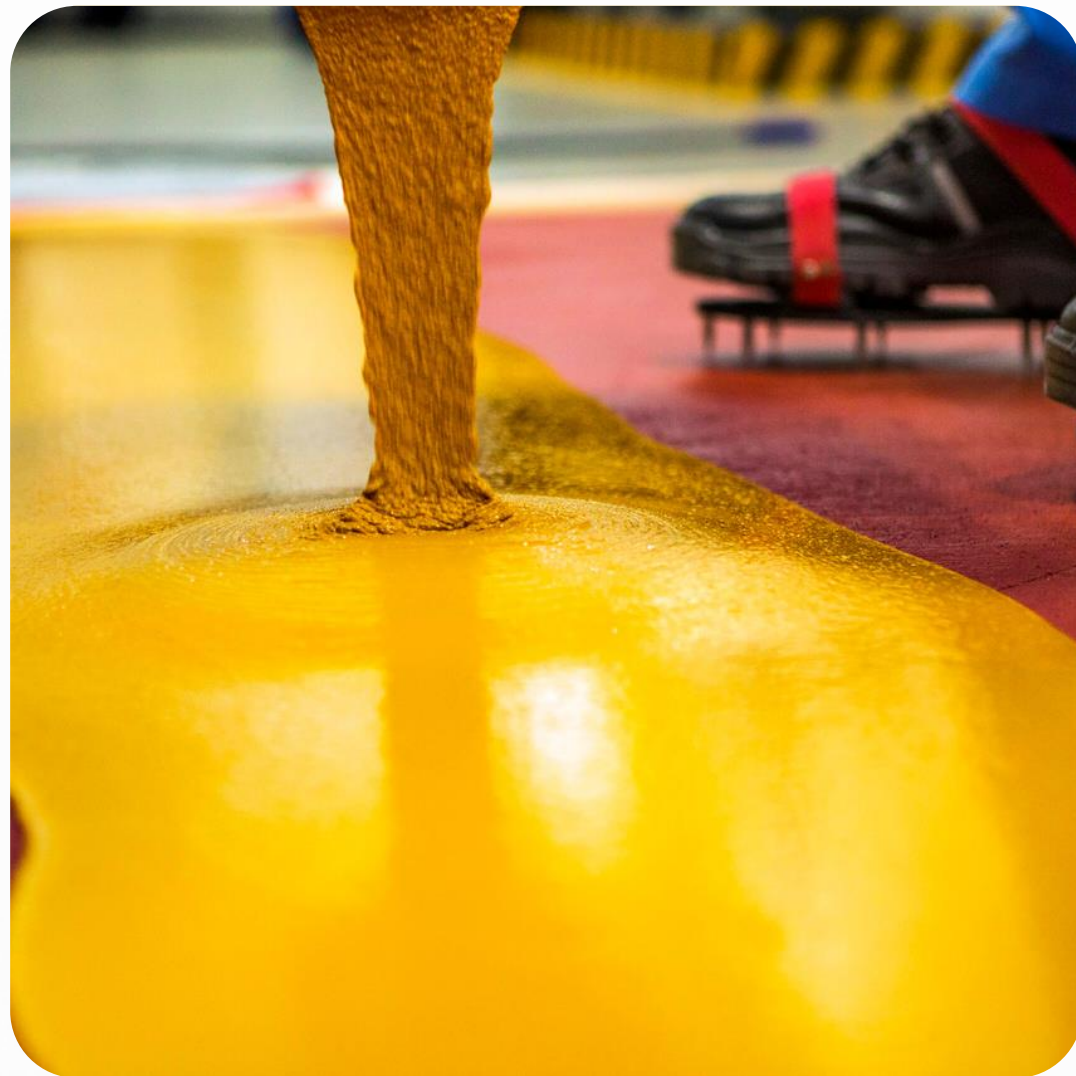

# INDUSTRIAL FLOORING

## Epoxy Screed Repair





# INDUSTRIAL FLOORING

## Bridge Painting



# INDUSTRIAL FLOORING

## Cementitious Material Coating

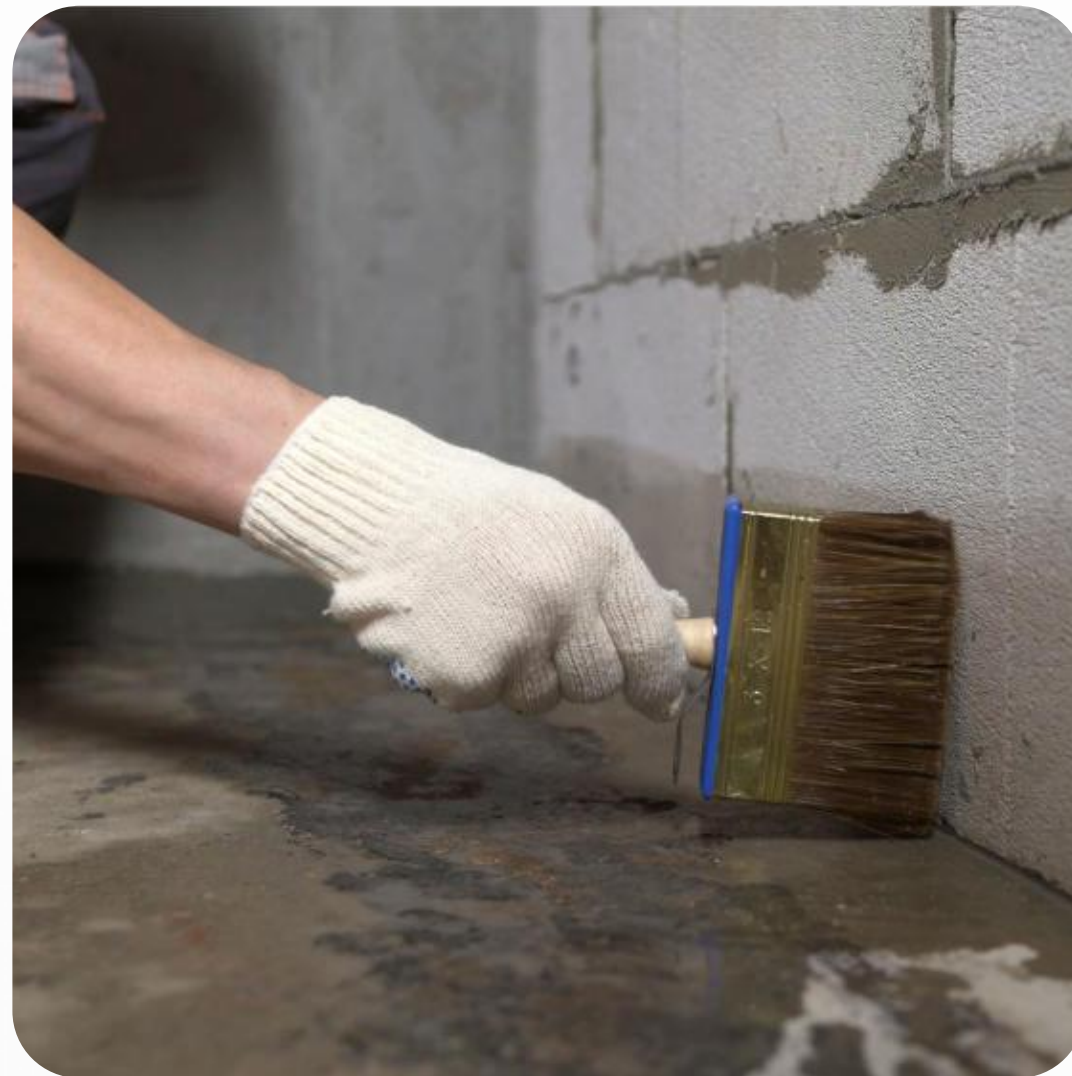

# INDUSTRIAL FLOORING

**Epoxy Self Leveling specially  
for SCECO Buildings**

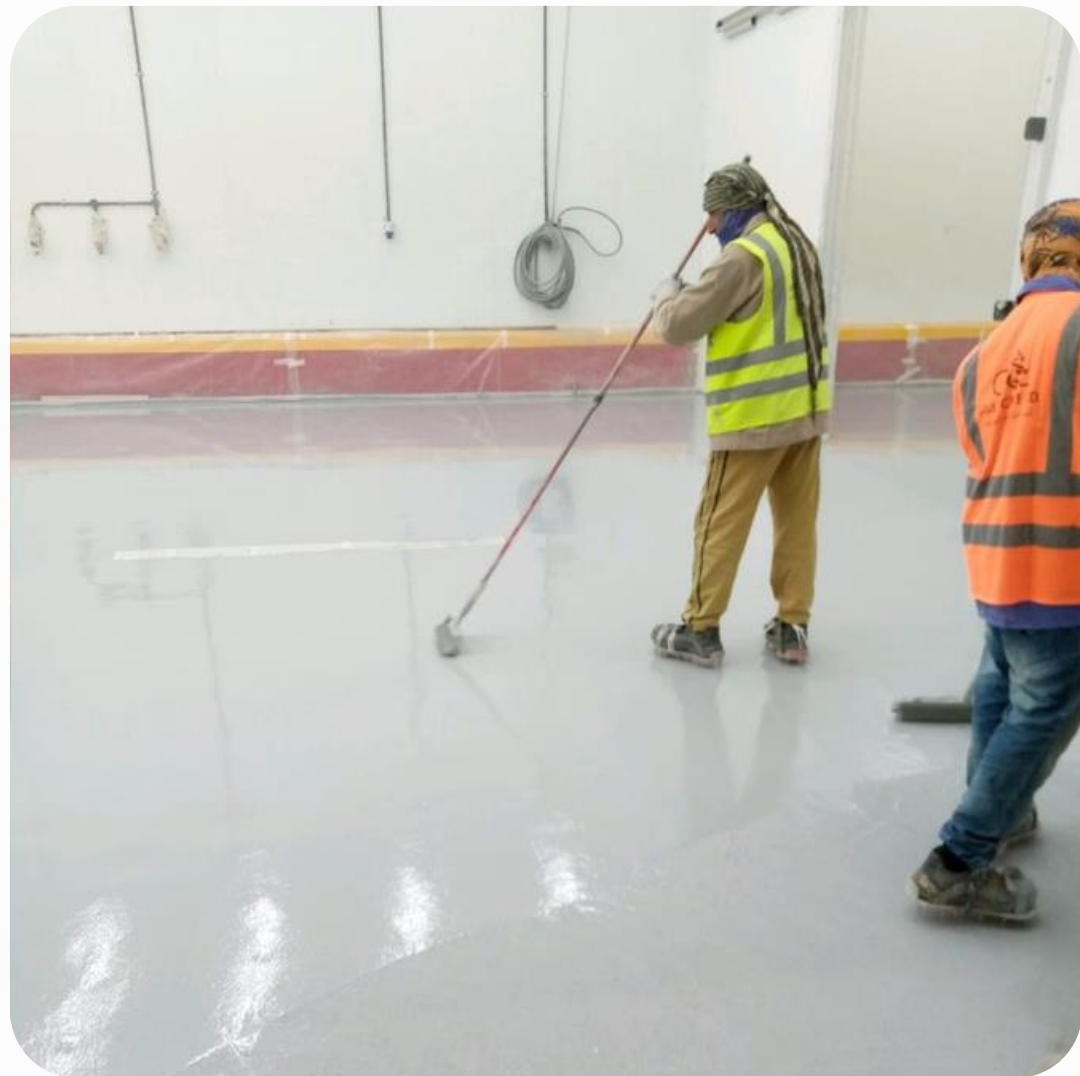

# INDUSTRIAL FLOORING

## Floor Traffic Deck Coating



# INDUSTRIAL FLOORING

## Floor Epoxy Resin Coating



# BRIDGE EXPANSION JOINT

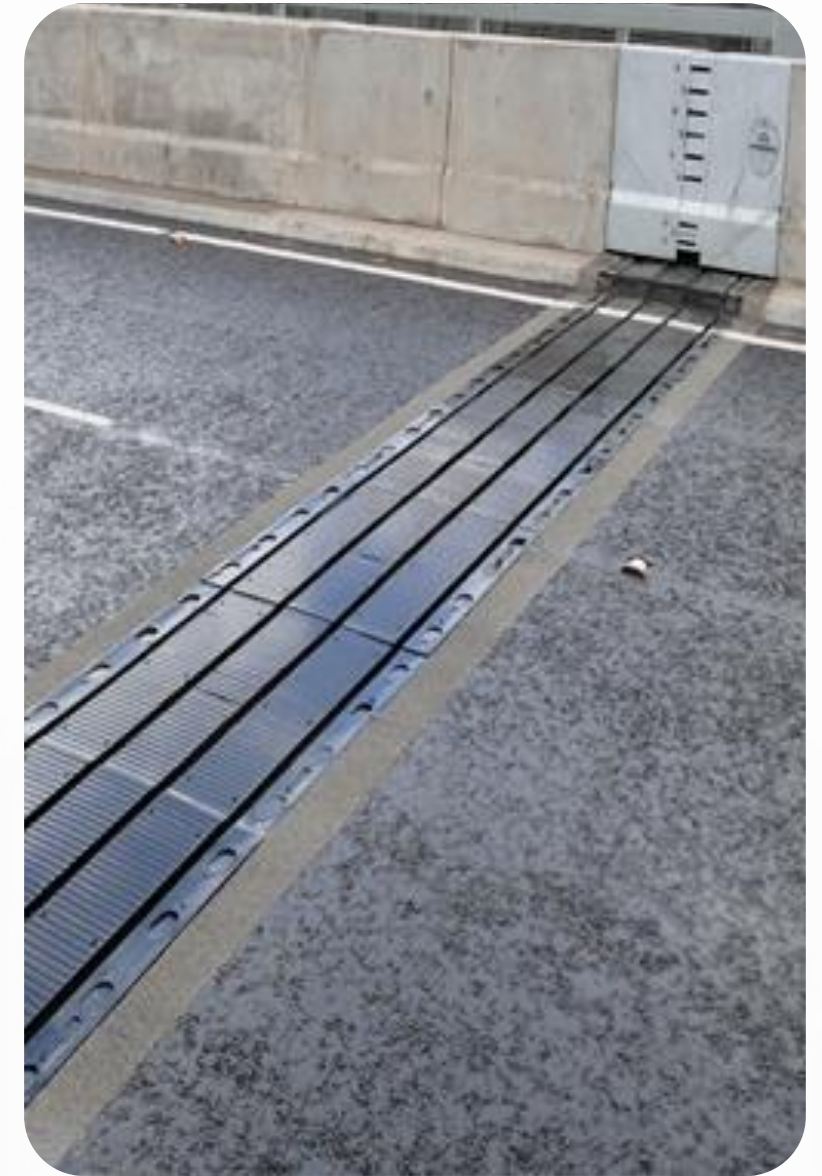



# WATER PROOFING

## PVC Waterproofing System





# WATER PROOFING

## PVC Waterproofing System



# WATER PROOFING

## PVC Waterproofing System



# WATER PROOFING

## PVC Waterproofing Membrane

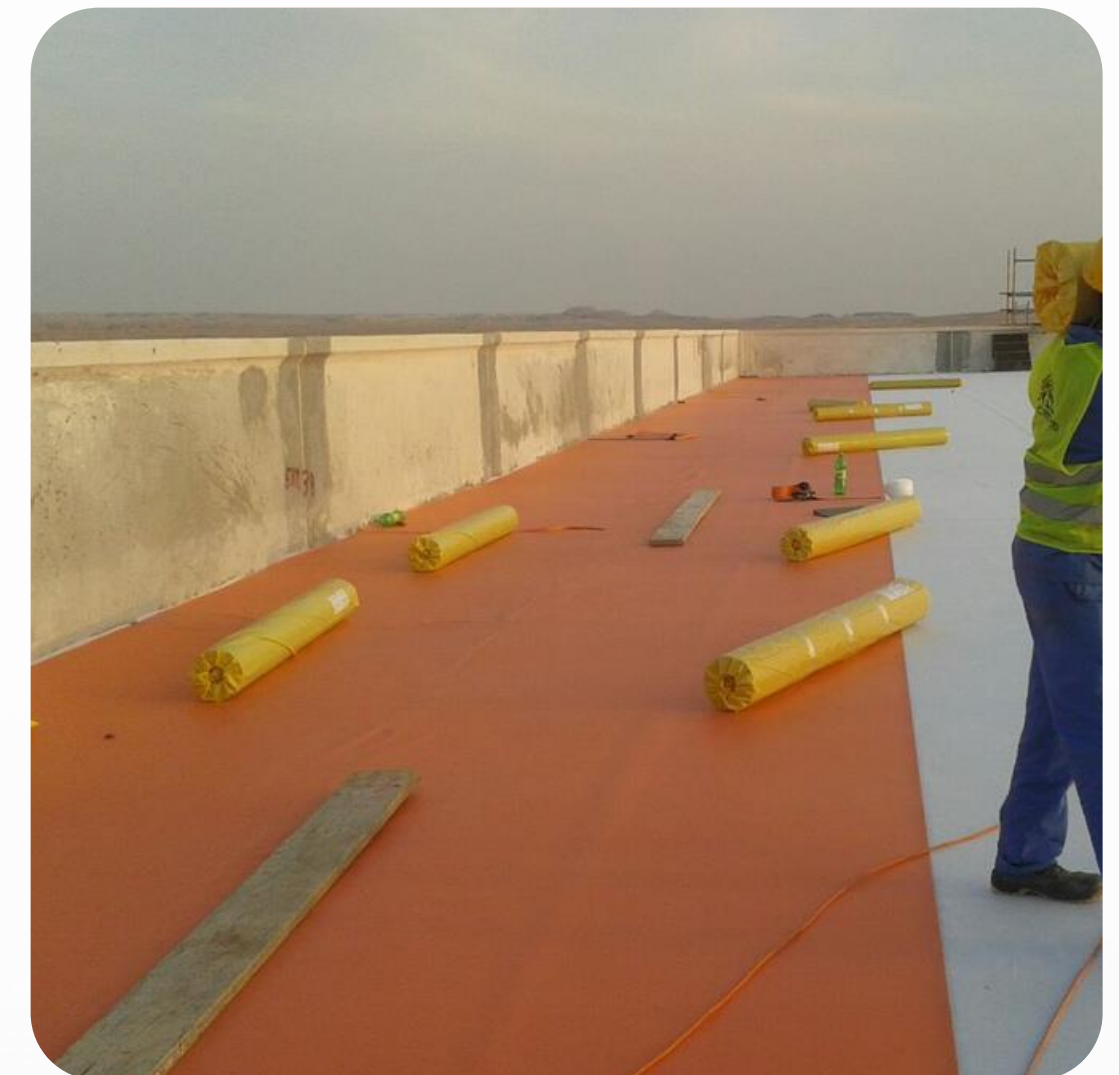

# WATER PROOFING

## Spray Polyurethane Foam

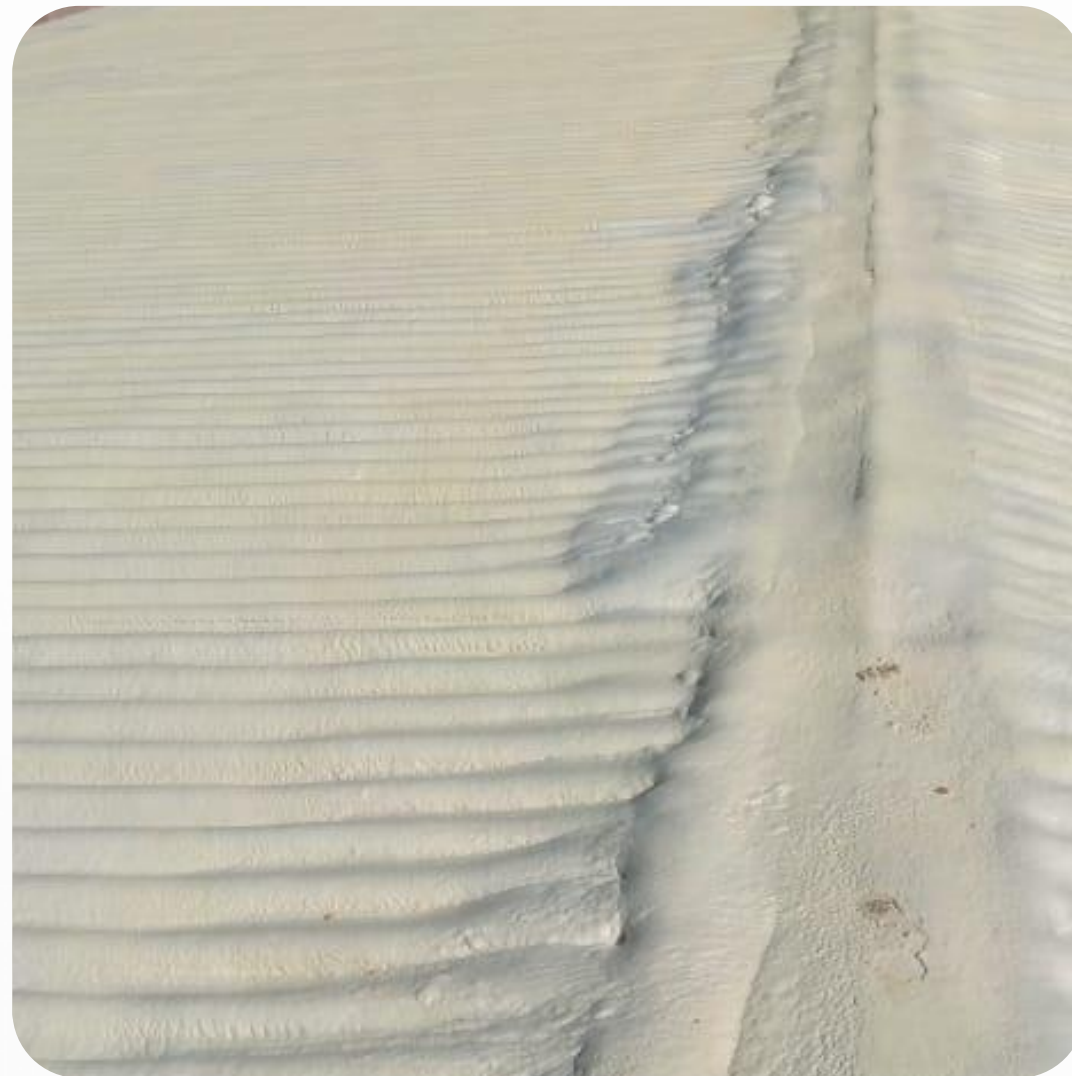

# WATER PROOFING

## Steel Tanks Epoxy Polyurethane Coating

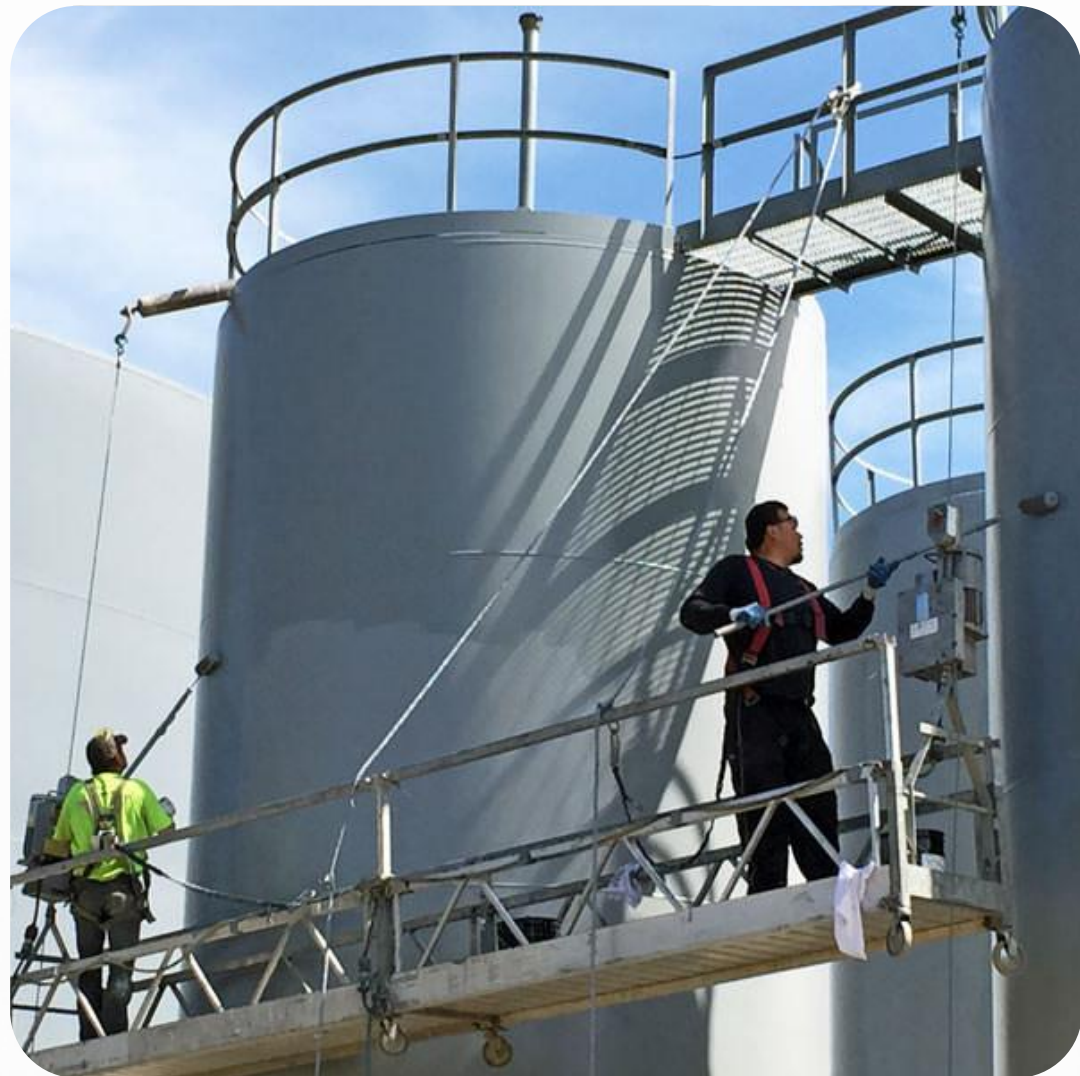

# WATER PROOFING

## Polyurethane Coating

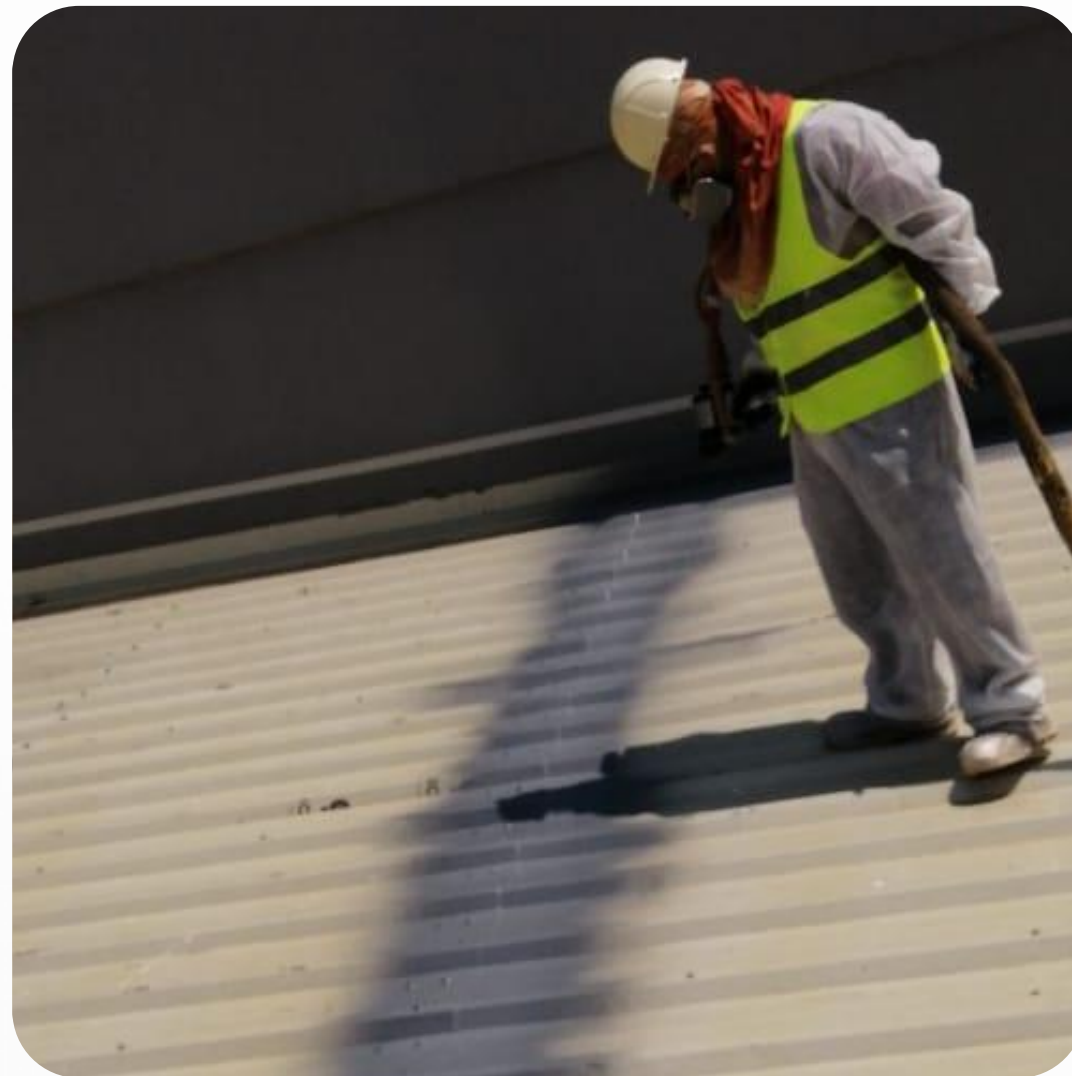

# WATER PROOFING

## Crystalline Coating



# WATER PROOFING

## Cementitious Coating





# WATER PROOFING

## Epoxy Coating



# WATER PROOFING

## TPO Waterproofing Membrane



# WATER PROOFING

## TPO Waterproofing Membrane



# WATER PROOFING

## HDPE Waterproofing Membrane

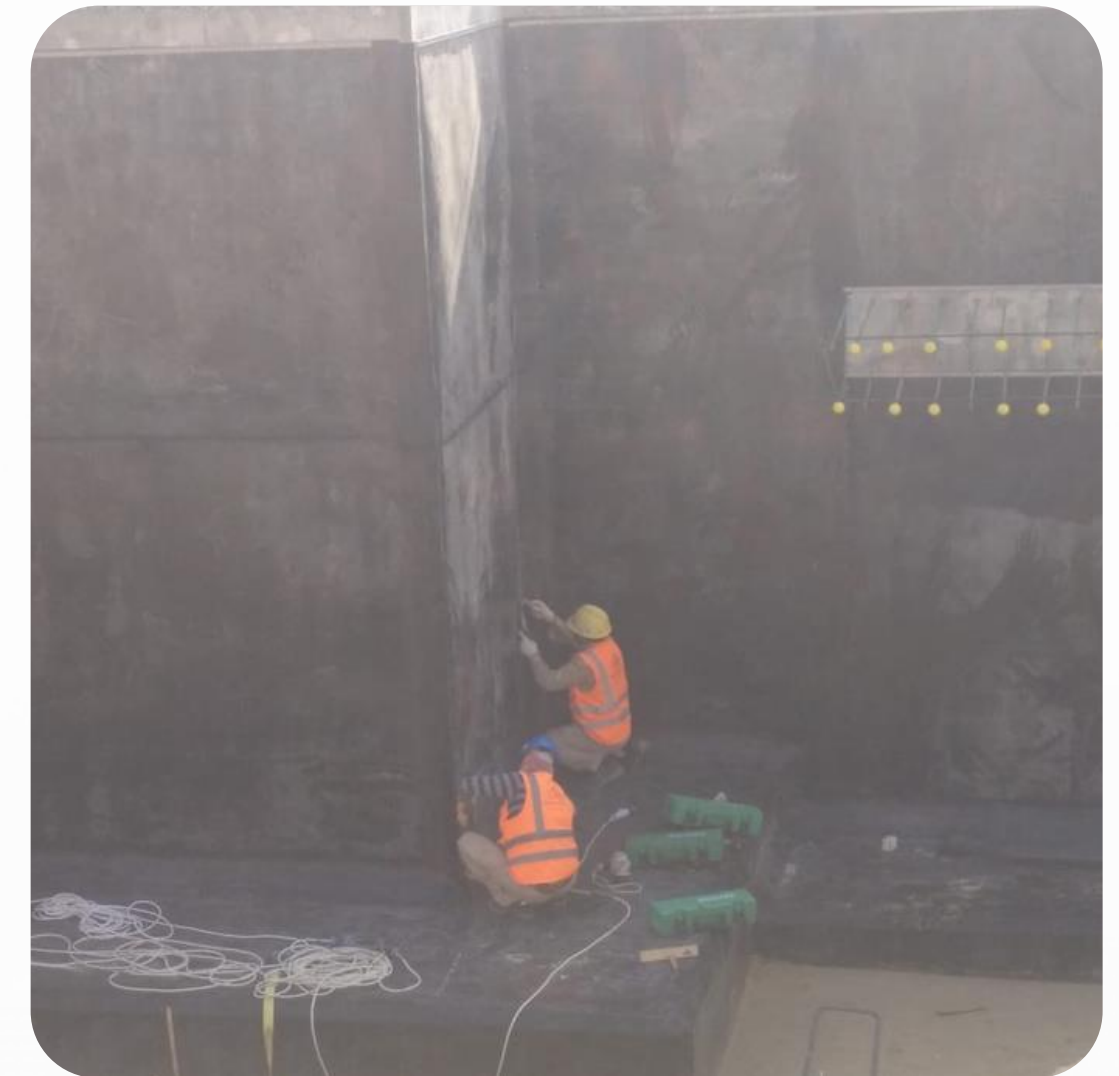
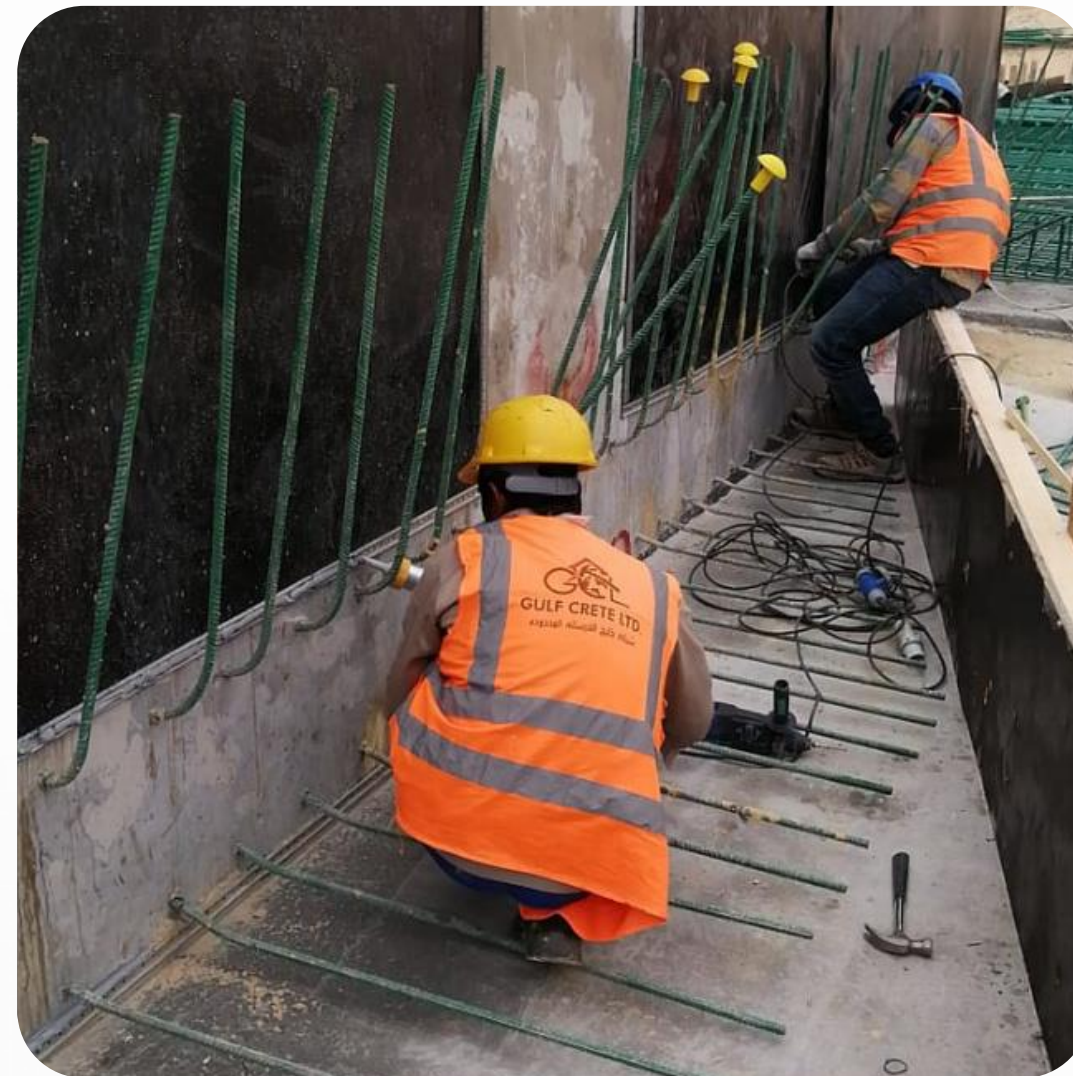

# WATER PROOFING

## EPDM Waterproofing Membrane

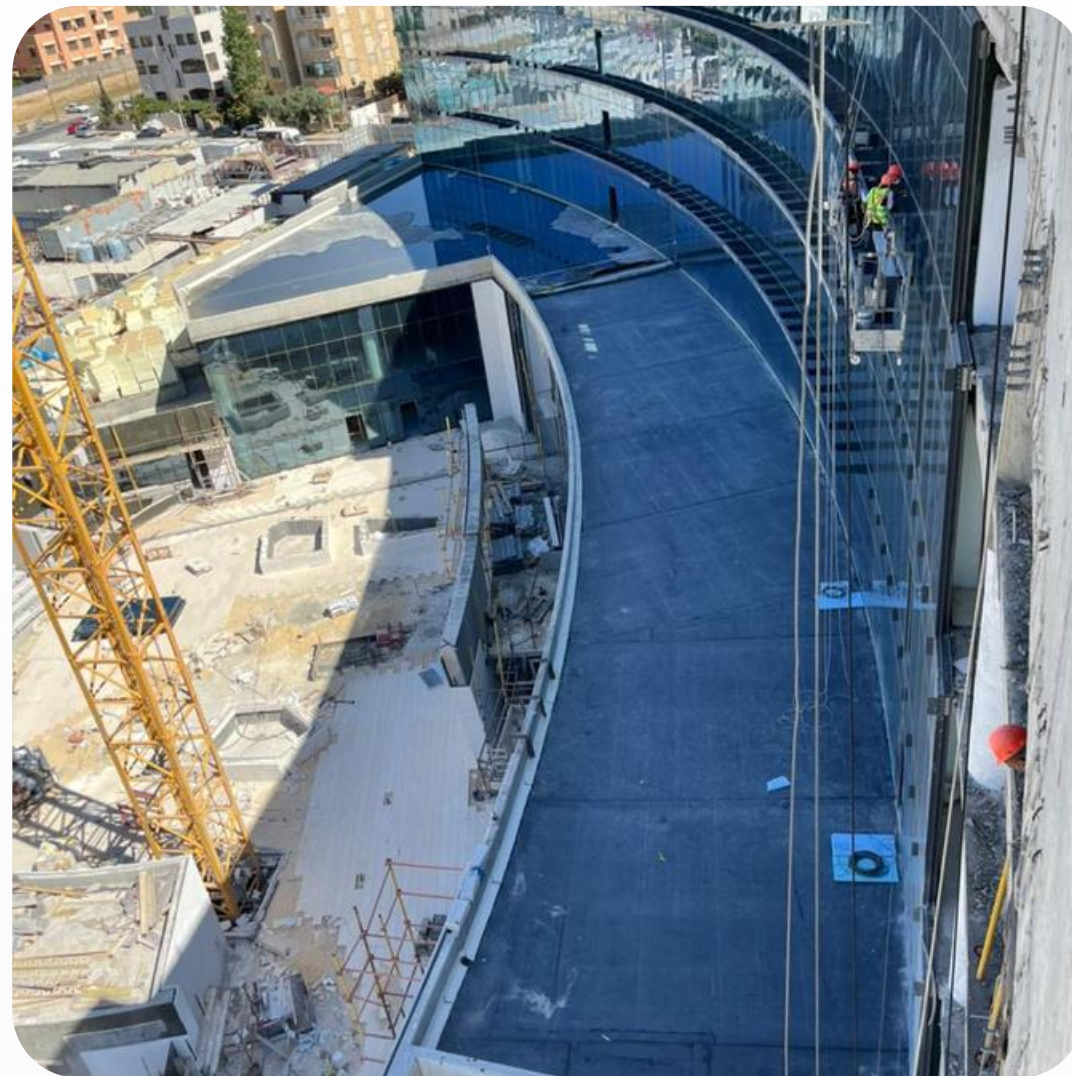

# WATER PROOFING

## Bituminate Waterproofing



# WATER PROOFING

## Foam Concrete Work

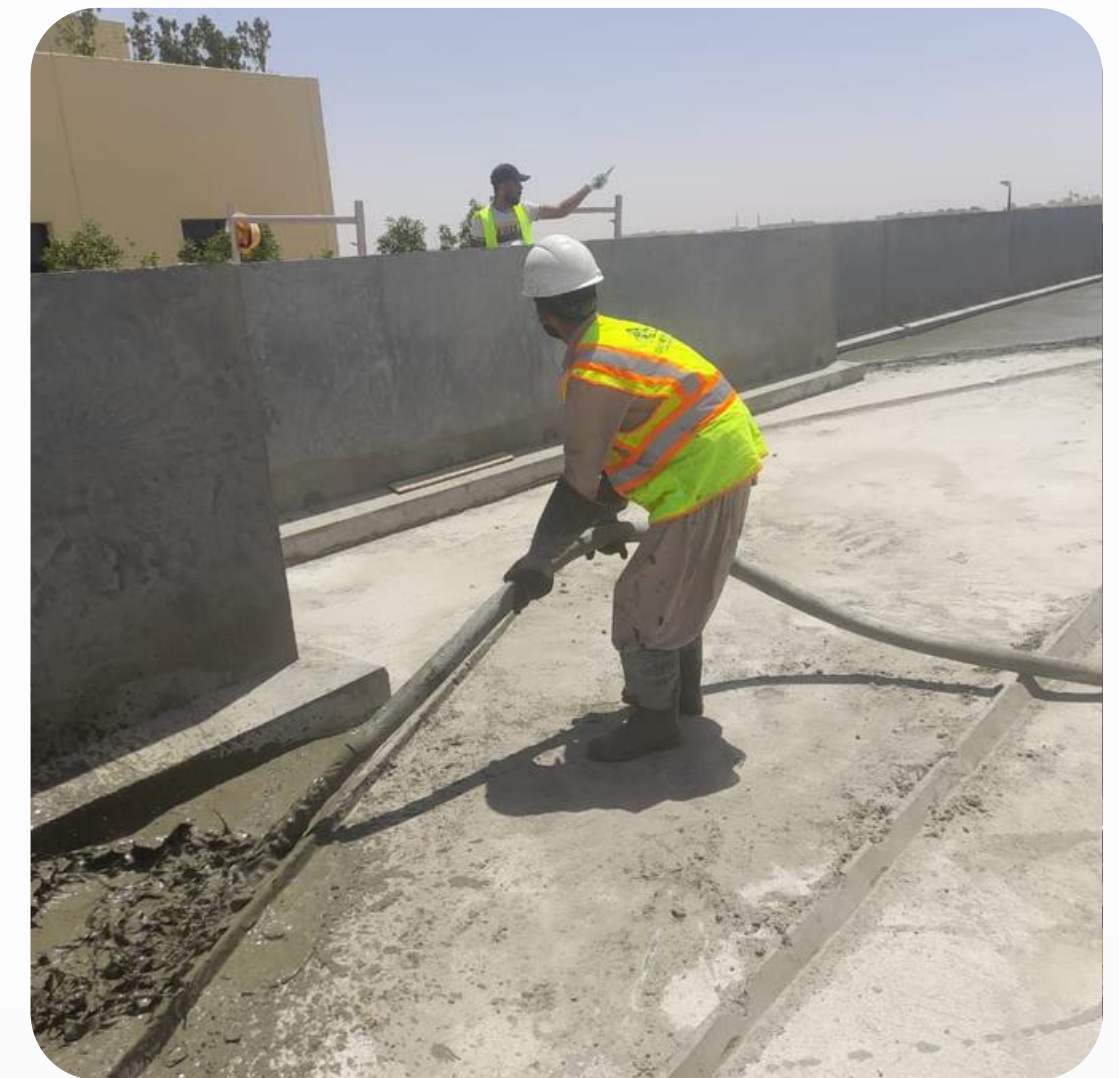

# FIRE PROOFING

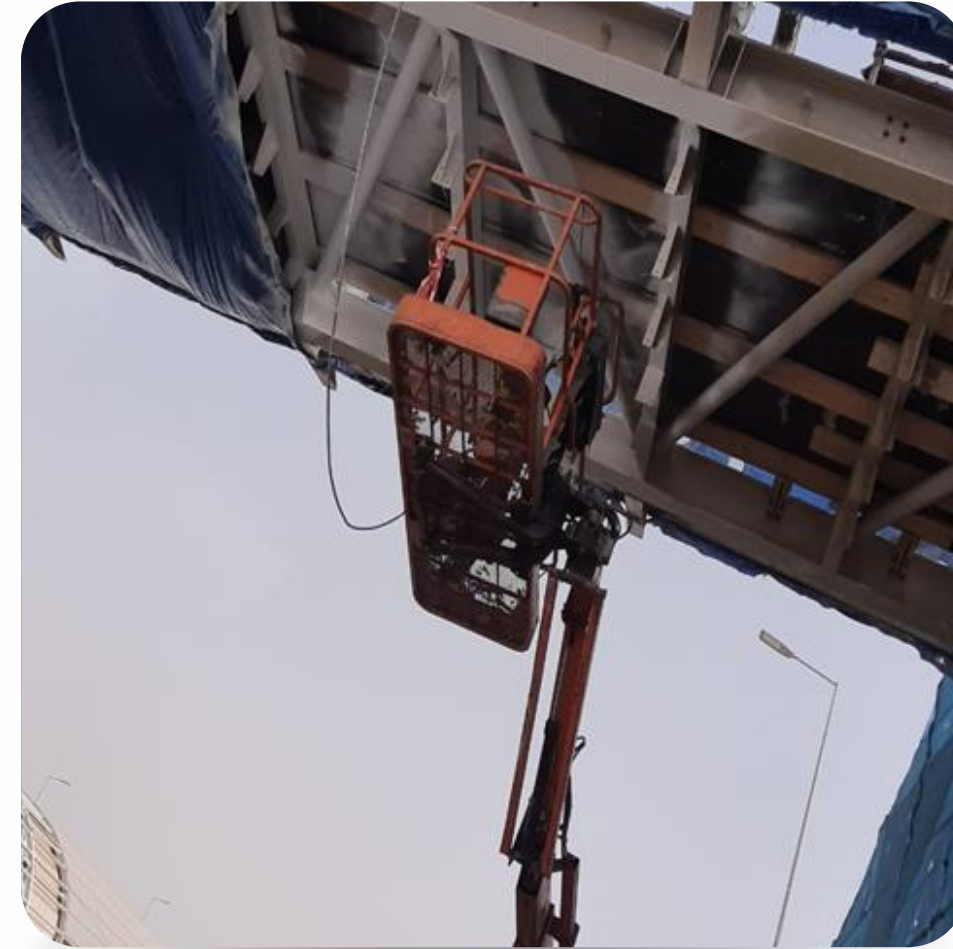



# FIRE PROOFING

## Cementitious Paint



# FIRE PROOFING



## Cementitious Paint



# FIRE PROOFING

## Intumescent Paint

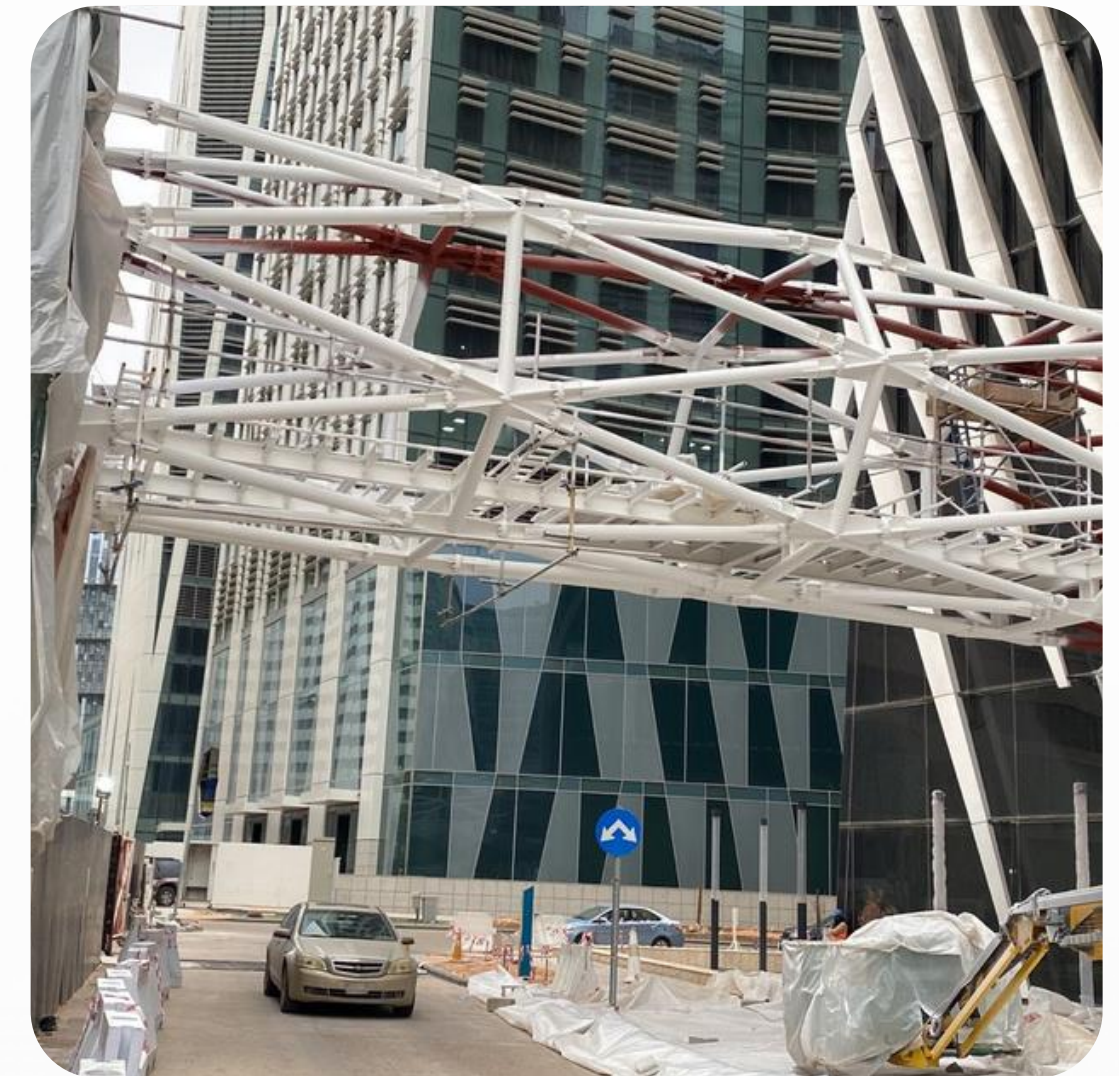
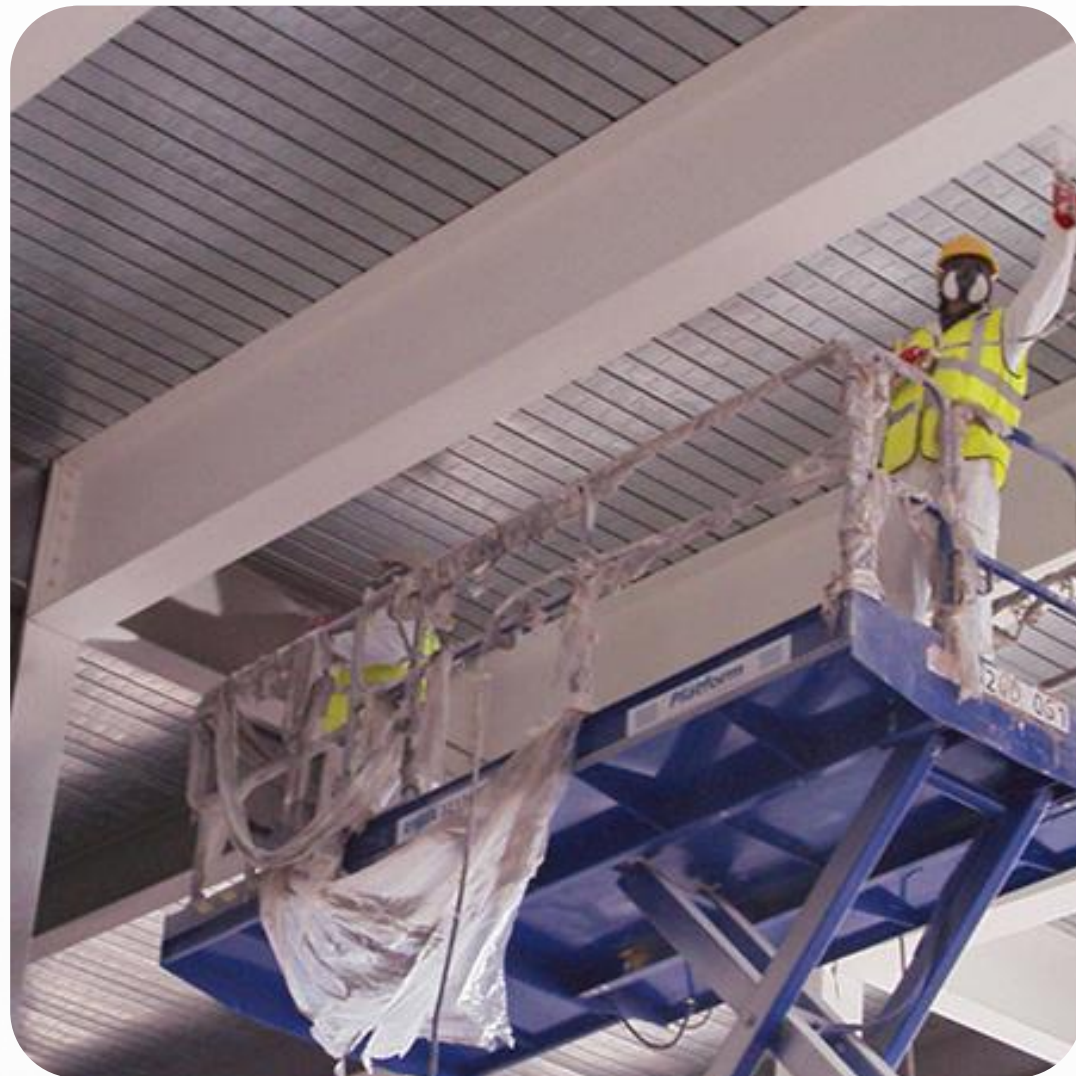

# FIRE PROOFING

## Intumescent Paint



# FITOUT AND RENOVATION

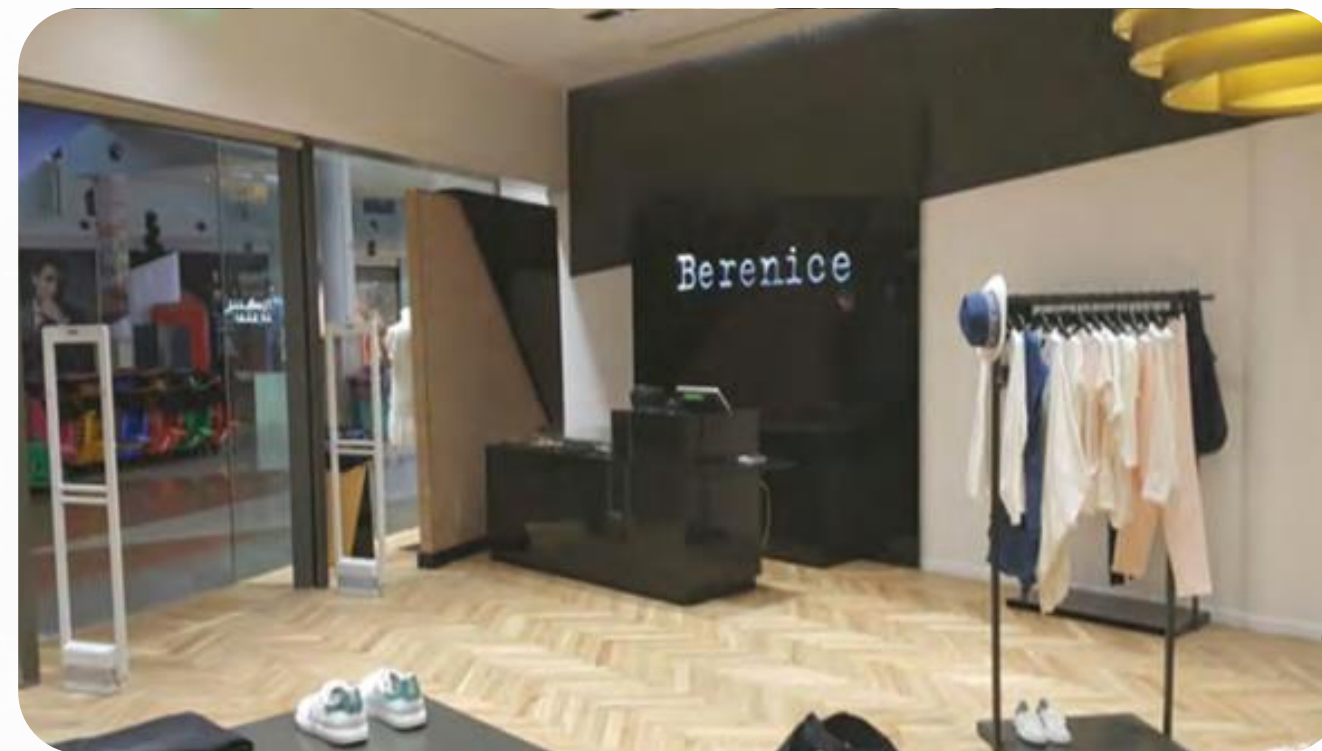

The background of the slide is a photograph of two hands shaking in a firm grip. The hands are wearing dark blue, pinstriped suit sleeves. The handshake is centered in the frame, and the text is overlaid on it.

# **PARTNERS & Suppliers**

# Our Partner & Suppliers

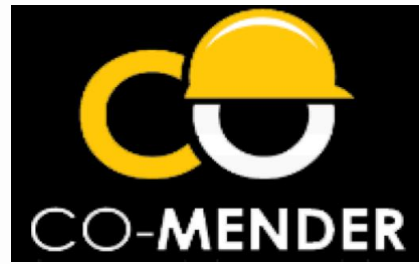



# MAJOR PROJECTS





# Water Proofing Projects

AREA	Work Scope	Status	Contract Amount - SAR
Riyadh	Bituminat Water Proofing Membrane ( APP & SBS )	Ongoing	SAR 2,200,000
Ras Al Khair	Builtup Waterproofing	Ongoing	SAR 16,000,000
Riyadh	Crystalline Waterproofing	Ongoing	SAR 1,791,640
Qiddiya	Cut & Cover Tunnel Pvc Waterproofing	Ongoing	SAR 24,800,000
Neom	Tunnel Pvc Waterproofing	Ongoing	SAR 67,000,000
Saudi Arabian Baytur Construction Co.	Water Leakage Injection Work	Sales Order	SAR 294,400
National Water Company (NWC) شركة المياه الوطنية	Water Proofing & Repair System	Sales Order	SAR 1,501,833
Ansab General Contracting Company شركة انساب للمقاولات العامة	Water Proofing PVC	Sales Order	SAR 99,188
National Water Company	Water Proofing	Sales Order	SAR 287,960
Gulf Builder for Trading & Contracting Co	Water Proofing	Sales Order	SAR 329,598

AREA	Work Scope	Status	Contract Amount - SAR
Saudi Real Estate Infrastructure Co (Binyah) الشركة العقارية السعودية للبنية التحتية مساهمة عامة	Water Proofing	Sales Order	SAR 25,047
QOTTUF AL JAZERAH LLC	Water Proofing	Sales Order	SAR 11,196
Dorar Tammam Contracting Company (DTC)	Water Proofing	Sales Order	SAR 222,755
Al Yamama Company	Water Proofing	Sales Order	SAR 15,870
BBIAGC JV	Water Proofing	Sales Order	SAR 384
Arab Supply & Trading Co. (Astra Construction) الشركة (استرا للإنشاءات) العربية للتموين والتجارة	Water Proofing	Sales Order	SAR 45,889
Advanced Construction For Cont.Co	Water Proofing	Sales Order	SAR 20,700
AL Khonaini International Co.	Water Proofing	Sales Order	SAR 2,855,645
Al Yamama Company	Water Proofing	Sales Order	SAR 10,868
Archirodon Group	Water Proofing	Sales Order	SAR 1,416,589
AL-HADA Contracting	Water Proofing PVC	Sales Order	SAR 17,250
Development Works Co.	Water Proofing	Sales Order	SAR 1,134,120

AREA	Work Scope	Status	Contract Amount - SAR
Hadania Trading & Contracting Co.	Water Proofing PVC	Sales Order	SAR 54,527
الشركة (Astra Construction) Arab Supply & Trading Co. (استرا للإنشاءات) العربية للتموين والتجارة	Water Proofing	Sales Order	SAR 3,127,093
الشركة (Astra Construction) Arab Supply & Trading Co. (استرا للإنشاءات) العربية للتموين والتجارة	Water Proofing	Sales Order	SAR 293,431
شركة شابورجي بالونجي ميد أيست Shapoorji Pallonji Mideast LLC	Water Proofing	Sales Order	SAR 3,968,434
الشركة (Astra Construction) Arab Supply & Trading Co. (استرا للإنشاءات) العربية للتموين والتجارة	Water Proofing	Sales Order	SAR 1,427,827
Saudi Constructioneers Ltd	Water Proofing	Sales Order	SAR 15,703,210
AL-HADA Contracting	Water Proofing PVC	Sales Order	SAR 179,330
شركة تطوير المباني TBC	Water Proofing	Sales Order	SAR 3,161,379
Khalifa A.Al-Mulhem Co.Ltd.,	Water Proofing	Sales Order	SAR 55,834
Saudi Constructioneers Ltd	Water Proofing	Sales Order	SAR 3,823,276
Shibh Al Jazira Contracting Company ( SAJCO )	Water Proofing	Sales Order	SAR 22,922,059

AREA	Work Scope	Status	Contract Amount - SAR
Saudi Constructioners Ltd	Water Proofing PVC / Bitum.	Sales Order	SAR 2,068,957
Branch of China Railway 18th Bureau Group Co.Ltd	Water Proofing / S.Adhesive	Sales Order	SAR 8,752,920
ACCIONA AGUA S.A SAUDI ARABIA CO.(JV) تضامن فرع شركة اكسيونا أجوا اس ايه وشركة الراشد للتجارة والمقاولات	Water Proofing	Sales Order	SAR 253,000
Al Yamama Company	Water Tank Epoxy	Sales Order	SAR 17,394
Al-Khobar	Waterproofing & Tank Coatings	Ongoing	SAR 2,000,000

AREA	Work Scope	Status	Contract Amount - SAR
Algurair / Riyadh Buss.	Water Proofing TPO.	Sales Order	SAR 5,068,957
Al Raqtan Factory	Water proofing TPO	Sales Order	SAR 6,752,920
Al Marai CPP3	Water Proofing TPO / PVC	Sales Order	SAR 3,253,000
Izdihar project	Waterproofing & Tank Coatings	Sales Order	SAR 2,17,394
Rawshan Project	Waterproofing & Tank Coatings	Ongoing	SAR 2,000,000

# Coating & Protective System

AREA	Work Scope	Status	Contract Amount - SAR
Tareg Al-Jaafari Cont. Est.,	Coating & Protective System	Sales Order	SAR 3,500,000
Al Shaheen metal industries	Coating & Protective System	Sales Order	SAR 67,239
Khalifa A.Al-Mulhem Co.Ltd.,	Coating & Protective System	Sales Order	SAR 58,490
NESMA & MABANI - NAS JV شركة نسما وشركاهم للمقاولات وتحالف شركتي المباني مقاولون عامون والأنظمة المتقدمة	Coating & Protective System	Sales Order	SAR 1,128,125
NESMA & MABANI - NAS JV شركة نسما وشركاهم للمقاولات وتحالف شركتي المباني مقاولون عامون والأنظمة المتقدمة	Coating & Protective System	Sales Order	SAR 164,896
Fourth Milling Company MC4	Coating & Protective System	Sales Order	SAR 427,859
SEPCOIII Electric Power Construction Co.Ltd.Branch فرع شركة سيبكو اليكتريك باور 111 كونستراكشن المحدودة	Epoxy Coating	Sales Order	SAR 28,000,000
Diriyah	Epoxy Flooring	Ongoing	SAR 1,927,202
Coating &	Coating &	Coating &	Coating &

AREA	Work Scope	Status	Contract Amount - SAR
Arab Supply & Trading Co. (Astra Construction) الشركة العربية للتموين والتجارة (استرا للإنشاءات)	Floor Coating	Sales Order	SAR 546,250
Saudi Constructioneers Ltd	Floor Coating	Sales Order	SAR 162,495
Tareg Al-Jaafari Cont. Est.,	Floor Epoxy Coating	Sales Order	SAR 923,289
Khalifa A.Al-Mulhem Co.Ltd.,	Floor Epoxy Coating	Sales Order	SAR 80,428
NESMA & MABANI - NAS JV شركة نسما وشركاهم للمقاولات وتحالف شركتي المباني مقاولون عامون والأنظمة المتقدمة	Floor Epoxy Coating	Sales Order	SAR 248,800
NESMA & MABANI - NAS JV شركة نسما وشركاهم للمقاولات وتحالف شركتي المباني مقاولون عامون والأنظمة المتقدمة	Floor Epoxy Coating	Sales Order	SAR 38,243
Arab Supply & Trading Co. (Astra Construction) الشركة العربية للتموين والتجارة ( للإنشاءات )	Flooring	Sales Order	SAR 868,581
NESMA & MABANI - NAS JV شركة نسما وشركاهم للمقاولات وتحالف شركتي المباني مقاولون عامون والأنظمة المتقدمة	Floor Epoxy Coating	Sales Order	SAR 366,390
Khalifa A.Al-Mulhem Co.Ltd.,	Floor Coating	Sales Order	SAR 7,220,039

# Rock Fall & Rock Bolt

AREA	Work Scope	Status	Contract Amount - SAR
Aqabat Al Salabat - Southren Region	Rock Fall Barrier / Netting / Shot crete	Sales Order	SAR 30,998,581
Neom / Audit 3	Rock Fall barrier	Sales Order	SAR 1,800,000
Neom / Audit 3 phase 2	Rock Fall barrier	Sales order	SAR 3,27,600
Salini Saudi Arabia	Rock Bolt	Sales Order	SAR 1,244,231
HAIF TRADING & CONTRACTING CO شركة هيف للتجارة والمقاولات	Rock Fall	Sales Order	SAR 24,837,240
China Railway Construction Co. LTD - Saudi	Rock Fall	Sales Order	SAR 1,117,800
Neom	Rockfall Protection / Shotcrete	Sales order	SAR 8,000,000



AREA	Work Scope	Status	Contract Amount - SAR
Aqabat Sinan	Rockfall Protection D&B	Sales order	SAR 80,000,000
Mofarreh Alharbi & Partners	Rockfall Protection System	Sales Order	SAR 402,500
Aqabat Thelle	Rockfall Protection&Shotcrete D&B	Sales order	SAR 7,000,000
Aqabat Dalah	Shot Crete	Sales Order	SAR 9,027,500
HAIF TRADING & CONTRACTING CO شركة هيف للتجارة والمقاولات	Shot Crete	Sales Order	SAR 4,600,000
Qiddiya	Shot Crete Works	Ongoing	SAR 4,600,000

# Fireproofing

AREA	Work Scope	Status	Contract Amount - SAR
Saudi Arabian Baytur Construction Co.	Fireproofing	Sales Order	SAR 60,375
AGILITY Co.	Fireproofing	Sales Order	SAR 190,616
International Building Systems Factory Co. Ltd. (IBSF)	Fireproofing	Sales Order	SAR 765,511
Arail Construction & Industrial Co. LTD.	Fireproofing	Sales Order	SAR 1,709,893
Saudi Arabian Baytur Construction Co.	Fire proof	Sales Order	SAR 532,350
Development Works Co.	Fire Proof	Sales Order	SAR 1,812,285
Lulu Hayber market	Fire Proof	Sales Order	800,000.00
Western Station - 3B2	Fire Proof	Sales Order	SAR 17,812,285

# Fireproofing

AREA	Work Scope	Status	Contract Amount - SAR
Riyadh Buss project	Fireproofing	Sales order	1,500,000
Riyadh Metro – 1F4	Fireproofing	Sales order	350,000.00
KAFD / Sky Bridge	Fireproofing	Sales order	984,000.00
KAFD / Steel building / SCC	Fireproofing	Sales Order	8000,000.00

# Soil Injection & Maintenance Works

AREA	Work Scope	Status	Contract Amount - SAR
National Water Company (NWC) شركة المياه الوطنية	Maintenance Works	Sales Order	SAR 714,725
National Water Company (NWC) شركة المياه الوطنية	Maintenance Works	Sales Order	SAR 1,298,954
KING FAISAL SPECIALIST HOSPITAL & RESEARCH CENTER	Smart Flooring	Sales Order	SAR 2,617,791
Riyadh	Smart Flooring For Hospital	Ongoing	SAR 3,000,000
Al Babtain Contracting	Soil Enjction	Sales Order	SAR 112,386
Nizar Kurdi Al-Muhandis - نزار كردي للاستشارات الهندسيه	Soil Enjction	Sales Order	SAR 159,464
Abdul Ali Al Ajmi Company	Soil Enjction	Sales Order	SAR 14,950
Abdul Ali Al Ajmi Company	Soil Enjction	Sales Order	SAR 5,980

# Structural Repair D&B

AREA	Work Scope	Status	Contract Amount - SAR
Umm Al-qura Cement	Strengthen Work	Sales Order	SAR 2,700,660
ARCHITECTS CONSTRUCTION	Strengthen Work	Sales Order	SAR 115,000
Al-Jubail	Structural Repairs	Sales order	SAR 11,000,000
Modern Arch MACC	Structural Strengthen & Repairing System	Sales Order	SAR 70,742
Khalifa A.Al-Mulhem Co.Ltd.,	Structural Strengthen & Repairing System	Sales Order	SAR 287,500
Taif	Strutural Repair D&B	Sales order	2.800,000
Qiddiya	Ongoing	Sales order	SAR 1,034,770
Arab Company for Laboratories & Soil الشركة العربية للمختبرات والتربة	Supply Of Drilling Tools	Sales Order	SAR 6,900
KADF	Column Jacketing / & CFRP	Sales order	3,700,000.00

# Structural Repair D&B

AREA	Work Scope	Status	Contract Amount - SAR
MOT SCHOOLS	CFRP	Sales Order	2,300,000.0
Bridges	CFRP / Concrete repair	Sales order	670,000.00
مجلس التعاون الخليجي	Concrete Footing Jackting	Sales order	800,000.00
NWC	Concrete Repair	Sales Order	1,200,000.00
STS / National Bank	Column Steel jacketing	Sales order	1,1340,000.00



**APPROVAL**

# APPROVAL



**ARAMCO**

أرامكو السعودية  
saudi aramco



**R.C.J & Y**



**SABIC**

سابك  
عنطاك



**NESMA & PARTNERS**

**Nesma** نسما  
& Partners وشركاهم



**SECOC**

الشركة السعودية للكهرباء  
Saudi Electricity Company  
Diligently Serving You



**SWCC**



المؤسسة العامة لتحلية المياه المالحة  
Saline Water Conversion Corporation



**NWC**

شركة المياه الوطنية  
National Water Company



# APPROVAL

✓ **BECHTEL**



✓ **EI-SEIF**



✓ **D.U.N.S**



✓ **Al-Khafji Joint Operation**



✓ **TRSDC**



✓ **GACA**





# GOVERNMENT CERTIFICATION

# Ministry of Commerce Certificate



رؤية 2030  
VISION 2030  
المملكة العربية السعودية  
KINGDOM OF SAUDI ARABIA

وزارة التجارة  
Ministry of Commerce

شركة خليج الخرسانة المحدودة



السجل التجاري: 1010419075

رمزك التجاري QR Code  
من خلاله يمكنك التحقق المباشر من المعلومات:

- السجل التجاري
- رخصة البلدية
- شهادة السعودة
- برنامج نطاقات
- شهادة الزكاة
- الغرفة التجارية

MCgovSA  
www.mc.gov.sa

# Ministry of Commerce Certificate



السادة/ شركة خليج الخرسانة المحدودة

نهنكم بدخول عالم الأعمال التجارية وإصدار سجلكم التجاري، ونتطلع أن يساهم هذا السجل في تحقيق تطلعاتكم، وأن يكتب الله لكم التوفيق والنجاح في عملكم التجاري وأن تكون شريكاً في تعزيز اقتصاد المملكة العربية السعودية.  
يسرنا إبلاغكم بأن رقم منشآتكم الموحد هو ٧٠٠١٨٥٦٦٥٢ وقد تم ربطه بالخدمات الحكومية التي تحتاجها مستقبلاً. وهي على النحو التالي:

الرقم:	رقم سجلكم التجاري للمنشأة	وزارة التجارة Ministry of Commerce
١.١.٤١٩.٧٥	رقم منشآتكم لدى وزارة الموارد البشرية والتنمية الاجتماعية	وزارة الموارد البشرية والتنمية الاجتماعية Ministry of Human Resources Development
٣٨٨٩٧٥	تم تسجيل منشآتكم مجاناً لمدة سنة في خدمة واصل التجاري	سجل SPL
١.٢١٣٤٨٨١	رقم منشآتكم لدى هيئة الزكاة والضريبة والجمارك	هيئة الزكاة والضريبة والجمارك Zakat, Tax and Customs Authority
٣.١.٩٩١٧٤٣	رقم منشآتكم لدى المؤسسة العامة للتأمينات الاجتماعية	تحت الإجراء
٧٨٤٨٧	رقم منشآتكم لدى الغرفة التجارية.	الغرفة التجارية السعودية Federation of Saudi Chambers
يوجد أكثر من رخصة	رقم رخصة "بلدية" فورية (في حال اختياركم)	بلديات balady



يُتيح تطبيق "نوافذ منشآت" العديد من الخدمات الممكنة لك في عالم الأعمال ومنها الحصول على الإرشاد والاستشارات، تطبيق "نوافذ منشآت" بوابة دخولك إلى عالم الأعمال، <https://www.monshaat.gov.sa/nawafth>



ويمكنك فتح حساب بنكي دون الحاجة إلى أي أختام لمنشآتكم

كما جمعنا لك كافة الأنظمة واللوائح بلغة بسيطة في دليل التاجر لتمارس عملك التجاري بسهولة [mc.gov.sa/trader/guide](http://mc.gov.sa/trader/guide)

920000667 | الرياض 11162  
Kingdom of Saudi Arabia | المملكة العربية السعودية

MCgovSA  
[www.mc.gov.sa](http://www.mc.gov.sa)

## شهادة تسجيل الشركة Company Registration Certificate



الرقم الموحد: ٧٠٠١٨٥٦٦٥٢  
رقم المنشأة: ١٠١٠٤١٩٠٧٥  
التاريخ: ١٤٣٥/٠٩/٠٥ هـ

الاسم التجاري للشركة: شركة خليج الخرسانة المحدودة  
نوعها: ذات مسئولية محدودة مختلطة

جنسيتها: سعودي

تبدأ من: ١٤٣٥/٠٩/٠٥ هـ وتنتهي في: ١٥٣٧/٠٩/١٩ هـ

مدة الشركة: ٩٩ سنة

مركزها الرئيسي: ٤٥١٣، ٧٠٦٠

الرمز البريدي: ١٢٢٨٢

ص.ب: ٢٠٦٤٧

هاتف: ١١٤٦٥٥٠٣٤

النشاط: للاطلاع على بيانات الأنشطة الرجاء مسح الرمز التجاري

رأس المال: ٥٠٠,٠٠٠ ريال سعودي

٢ فتحى محمد رسمي عبدالفتاح الكوسا

١ خالد ابراهيم محمد الشامخ

٤

٦

٨

١٠

١٢

١٤

١٦

سلطات المدير/المديرون: حسب ما نص عليه عقد الشركة

الرياض

بأنه تم تسجيل الشركة المذكورة أعلاه بمدينة: الرياض

وتاريخ: ١٤٤٣/١٠/٢٨ هـ

بموجب الإيصال رقم: ٢٩٨٥٤٤٨٣

وتنتهي صلاحية الشهادات في: ١٤٤٨/٠٨/٠٧ هـ



To Verify The Information Of This Certificate Visit <http://mc.gov.sa> بمعلوماتكم التحقق من صحة هذه الشهادة بالدخول على  
+966 11 294 4444 | الرياض 11162 | Kingdom of Saudi Arabia | المملكة العربية السعودية | [www.mc.gov.sa](http://www.mc.gov.sa) MCgovSA @





# \*Saudi Construction Authority \*Tax & Customs Authority

SCA  
الهيئة السعودية للمقاولين  
Saudi Contractors Authority

تاريخ الإصدار: 13/03/2023 م

شهادة  
عضوية  
مقاول

طبقاً للنظيم الهيئة السعودية للمقاولين فإننا نشهد بأن  
شركة خليج الخرسانة المحدودة  
رقم العضوية: 100006947  
مسجل في عضوية الهيئة حسب الإجراءات العتيقة و قد أعطي هذه الشهادة بناء على ذلك

تاريخ نهاية العضوية: 13/03/2024 م  
الرجاء التحقق من صحة وصحة الشهادة عبر زيارة الرابط <https://www.sca.org.sa>

صدرت هذه الشهادة من الهيئة السعودية للمقاولين وتحت ملكة الهيئة ويجب  
إعادتها للهيئة المصدرة في حال إنهاء العضوية لأي سبب كان  
لمزيد من المعلومات عن الشهادة يرجى زيارة موقعنا  
[www.sca.org.sa](http://www.sca.org.sa) أو الاتصال على الرقم +966920000968  
جميع الحقوق محفوظة © الهيئة السعودية للمقاولين

م. ثابت مبارك آل سويد  
الأمين العام  
الهيئة السعودية للمقاولين  
رقم الهاتف: +966920000968  
البريد الإلكتروني: [info@sca.sa](mailto:info@sca.sa)  
[sca.sa](http://sca.sa)

VISION 2030  
رؤية السعودية 2030  
الهيئة السعودية للمقاولين  
رقم الترخيص: 1327-8292  
البريد الإلكتروني: [info@sca.sa](mailto:info@sca.sa)

1020184223

TIN: ٣٠١٠٩٩١٧٤٣ الرقم المميز  
Certificate No.: ١٠٢٠١٨٤٢٢٣ رقم الشهادة  
Issue Date: ١٤٤٤/٠٩/٢٨ تاريخ الاصدار

هيئة الزكاة والضريبة والجمارك  
Zakat, Tax and Customs Authority  
المملكة العربية السعودية  
Kingdom of Saudi Arabia

شهادة  
Certificate

The Zakat, Tax and Customs Authority certifies that the Taxpayer

تشهد هيئة الزكاة والضريبة والجمارك أن المكلف /

شركة خليج الخرسانة المحدودة

Entity Unified No. / ID No. ٧٠٠١٨٥٦٦٠٢ الرقم الموحد للمنشأة / رقم هوية

Commercial Registration/License/ Contract No. ١٠١٠٤١٩٠٧٥ سجل تجاري / رخصة / عقد رقم

Has submitted his tax return for the period ending on 31/12/2022 AD, and he was granted the certificate to complete all his transactions including the payment of the final amount due on the contract.  
The Certificate is valid until 21/10/1445 AH corresponding to 30/04/2024 AD

قدم إقراره عن الفترة المنتهية في ٧/١٠/١٤٤٤ هـ، وقد منح هذه الشهادة لإنهاء جميع معاملاته بما في ذلك صرف مستحقاته النهائية عن العقود.  
يسري مفعول هذه الشهادة حتى تاريخ ١١/١٠/١٤٤٥ هـ الموافق ٣٠/٠٤/٢٠٢٤ م

( The Twenty first of Shawwal one thousand four hundred forty-five Hijri ) ( الحادي والعشرون من شوال ألف وأربعمائة وخمسة وأربعون هجري )

لا يعتد بهذه الشهادة إلا بعد التحقق من موقع الهيئة الإلكتروني: [www.zatca.gov.sa](http://www.zatca.gov.sa)  
This certificate is not valid until verified by the Authority's Website: [www.zatca.gov.sa](http://www.zatca.gov.sa)

zатca.gov.sa 19993 @zatca\_sa

هذه الوثيقة مستخرجة من النظام الآلي ولا تحتاج إلى توقيع ولا يعتد بهذه الشهادة إلا بعد التحقق من موقع الهيئة [www.zatca.gov.sa](http://www.zatca.gov.sa)

2/1



الدرجة الثانية

## شهادة

### تصنيف مقدمي خدمات المدن

تمنح وزارة الشؤون البلدية والقروية والإسكان شهادة تصنيف بالدرجة

للمنشأة شركة خليج الخرسانة المحدودة

للمنشأة



بيانات المنشأة	رقم السجل التجاري/ الترخيص	تاريخ إصدار السجل التجاري/ الترخيص	اسم مالك المنشأة	نوع المنشأة	جنسية المنشأة	رأس المال
	1010419075	02/07/2014	خالد ابراهيم محمد التمامح			4737785

بيانات شهادة التصنيف	رقم الشهادة	تاريخ الإصدار	حجم المنشأة	درجة التقييم الائتماني	درجة التقييم الفني
	20212138	09/08/2021		BBB	73.55

أنشطة شهادة التصنيف	القطاع	الأنشطة
	التشييد والبناء	الإنشاءات العامة للمباني السكنية، الإنشاءات العامة للمباني الغير السكنية، يشمل (المدارس، المستشفيات، الفنادق... الخ) إنشاء المطارات ومرافقها، الإنشاءات العامة للمباني الحكومية، إنشاءات المباني الجاهزة في المواقع، ترميمات المباني السكنية والغير سكنية، إنشاء الجسور والأتفاق، إصلاح وصيانة الطرق والشوارع والأرصفة ومستلزمات الطرق، إصلاح وصيانة الجسور والأتفاق، إصلاح وصيانة قنوات الري والسقي وأبراج تخزين المياه الرئيسية، إصلاح وصيانة محطات ومشاريع الصرف الصحي وشبكات المجاري والمضخات، إصلاح وصيانة محطات وأبراج الاتصالات السلكية واللاسلكية والرادار، إنشاء وإقامة محطات وأبراج الاتصالات السلكية واللاسلكية والرادار، إنشاء أرصفة الموانئ والمرافق البحرية، إنشاء الموانئ والمراسي السياحية (المارينا)

وكيل الوزارة لتنظيم مشغلي المدن

م. فيصل بن حسين الصنقر

- يسري مفعول هذه الشهادة حتى تاريخ 09/08/2025  
- تصدر هذه الشهادة إلكترونياً وعلى الجهات المالكة للمشاريع التحقق من الشهادة المقدمة من خلال موقع الوزارة.



2/2

الدرجة الثانية

ملحق الشهادة

شركة خليج الخرسانة المحدودة

اسم المنشأة

رقم السجل التجاري / الترخيص

1010419075

الأنشطة	القطاع	أنشطة شهادة التصنيف
تركيب وإصلاح وصيانة الابواب الاوتوماتيكية، تركيب وإصلاح وصيانة أنظمة التنظيف المركزية، تركيب وإصلاح وصيانة أنظمة العوازل الحرارية والمائية، تشطيب المباني، تركيب الابواب والشبابيك وإطارات الابواب (الشرشوب) والدرزينات والسلالم والمطابخ الخشبية، تركيب المظلات والسواتر، تركيب السيراميك والكاشي، تركيب الرخام، تركيب الحجر جلي وتلميع البلاط والرخام، تغطية الارضيات خشب الباركيه، تغطية الارضيات بالمطاط والمشمع والبلاستيك، أعمال تركيب الديكورات المختلفة، أعمال التزيين ولصق ورق الحائط، أعمال التجصيص والمساح، أعمال الدهانات والطلاء للمباني الداخلية والخارجية، أعمال الدهانات والطلاء لهيكل الهندسة الحديثة، تركيب الزجاج والمرابا للمباني، تركيب زجاج واجهات الابراج، تنظيف المباني الجديدة بعد الإنشاء، التركيبات الداخلية للمحلات والمباني المتحركة والقوارب، أعمال تركيب الطابوق، أعمال تركيب الصخور، إنشاء حمامات السباحة، تنظيف المباني بالبخر وتسخين الرمل إنشاء السدود، تنظيف الممرات المائية، إنشاء كاسرات الأمواج والحماية للأرصعة، اعداد وتجهيز المواقع من الحفر والتسوية، صب القواعد والاساسات، سحب المياه الجوفية وتجفيف المواقع، القطع الصخري باستخدام المواد المتفجرة، تركيب وصيانة أجهزة ومعدات الإنذار من الحريق، تركيب وصيانة الأجهزة الأمنية، تركيب وصيانة أجهزة السلامة المرورية، تركيب شبكات الطاقة الشمسية وصيانتها وإصلاحها، تركيب وإصلاح وصيانة أنظمة العوازل الحرارية والمائية، تشطيب المباني، أعمال الدهانات والطلاء للمباني الداخلية والخارجية، أعمال الدهانات والطلاء لهيكل الهندسة الحديثة، أعمال تركيب الصخور	التشييد والبناء	أنشطة شهادة التصنيف

وكيل الوزارة لتنظيم مشغلي المدن

م. فيصل بن حسين الصقار

- يسري مفعول هذه الشهادة حتى تاريخ 09/08/2025

- تصدر هذه الشهادة إلكترونياً وعلى الجهات المالكة للمشاريع التحقق من الشهادة المقدمة من خلال موقع الوزارة.



# Saudi VAT Registration Certification



100191004857715

تاريخ الإصدار: 2019/01/22  
الرقم المميز: 3010991743



الهيئة العامة للزكاة والدخل  
General Authority of Zakat & Tax



## شهادة تسجيل في ضريبة القيمة المضافة VAT Registration Certificate

تشهد الهيئة العامة للزكاة والدخل بأن المكلف أدناه مسجل في ضريبة القيمة المضافة بتاريخ 2017/08/24

Hereby, The General Authority of Zakat & Tax (GAZT) certifies that the taxpayer below is VAT registered on 24/08/2017

اسم المكلف:	شركة خليج الخرسانة المحدودة	Taxpayer Name:
رقم التسجيل الضريبي:	301099174300003	VAT Registration Number:
تاريخ نفاذ التسجيل:	2018/01/01	Effective Registration Date:
عنوان المكلف:	الرياض، الورود، ابن مطير الحكمي، 11323	Taxpayer Address:



كمكلف مسجل في ضريبة القيمة المضافة، لا يجوز لك تحصيل ضريبة القيمة المضافة من عملائك قبل تاريخ نفاذ التسجيل بالضريبة. في حال تبين غير ذلك، ستقوم الهيئة العامة للزكاة والدخل بتنفيذ الغرامات المستحقة

هذه الوثيقة مرسلة من النظام الآلي ولا تحتاج إلى توقيع  
- الهيئة العامة للزكاة والدخل -



100191004857715

تاريخ الإصدار: 2019/01/22  
الرقم المميز: 3010991743



الهيئة العامة للزكاة والدخل  
General Authority of Zakat & Tax



اسم المكلف:	شركة خليج الخرسانة المحدودة	Taxpayer Name:
رقم السجل التجاري/الرخصة/العقد:	1010419075	CR / License / Contract No.:
الفترة الضريبية:	ربع سنوي-Quarterly	Tax Period:
تاريخ استحقاق أول إقرار ضريبي:	2018/04/30	First Filing due date:



كمكلف مسجل في ضريبة القيمة المضافة، لا يجوز لك تحصيل ضريبة القيمة المضافة من عملائك قبل تاريخ نفاذ التسجيل بالضريبة. في حال تبين غير ذلك، ستقوم الهيئة العامة للزكاة والدخل بتنفيذ الغرامات المستحقة

هذه الوثيقة مرسلة من النظام الآلي ولا تحتاج إلى توقيع  
- الهيئة العامة للزكاة والدخل -



# \* General Organization for Social Insurance

## \* Human Resources Certification

رؤية  
VISION 2030  
المملكة العربية السعودية  
KINGDOM OF SAUDI ARABIA



### شهادة سعودة

رقم الشهادة 188139-20764358  
تاريخ الإصدار 2023-03-13  
تاريخ الانتهاء 2023-09-24  
تاريخ التجديد 2023-06-26

رقم المنشأة 1-388975

اسم المنشأة شركة خليج الخرسانة المحدودة

حالة الشهادة نشط

رقم السجل التجاري 1010419075

الرقم الوطني الموحد 7001856652



تشهد وزارة الموارد البشرية والتنمية الاجتماعية بأن المنشأة المذكورة أعلاه حققت نسب التوطين المطلوبة منها

وتم منحها هذه الشهادة حسب طلبها

الشهادة معتمدة من صاحب الصلاحية ولا تحتاج إلى توقيع أو ختم



المؤسسة العامة للتأمينات الاجتماعية  
General Organization for Social Insurance

التاريخ ١٤٤٤/١٢/٠٨  
الموافق ٢٦/٠٦/٢٠٢٣  
رمز الشهادة ٥٥٥٦٣٥٤٣

### شهادة

إسم المنشأة : شركة خليج الخرسانة المحدودة

الرياض  
السعودية  
رقم الإشتراك : ٥٠٨١٨٥٦٧٧  
رقم السجل التجاري: ١٠١٠٤١٩٠٧٥  
مصدره :

رقما	كتابة
٢٦	ستة و عشرون مشتركا
١٤٦	مائة و ستة و اربعون مشتركا
١٧٢	مائة و اثنان و سبعون مشتركا

عدد المشتركين السعوديين  
عدد المشتركين غير السعوديين  
المجموع

تشهد المؤسسة العامة للتأمينات الاجتماعية بأن المنشأة المذكورة أعلاه قد أوفت بالتزاماتها تجاه المؤسسة وفق البيانات المقدمة منها حتى تاريخ إصدار هذه الشهادة ، والتي تم منحها لتقديمها لأية جهة تطلبها ، وهي صالحة لجميع الأغراض التي نص عليها نظام التأمينات الاجتماعية في المادة (١٩/٦) منه.

هذه الشهادة سارية المفعول حتى ١٤٤٥/٠١/٠٧ هـ.

يلزم التحقق من صحة وصلاحية الشهادة عبر زيارة الرابط  
أدناه في الموقع الإلكتروني للمؤسسة العامة للتأمينات الاجتماعية  
أو عن طريق استخدام  
الرمز المعرف التالي :



[www.gosi.gov.sa/vc](http://www.gosi.gov.sa/vc)

( الشهادة معتمدة من صاحب الصلاحية ولا تحتاج إلى توقيع أو ختم )

[www.gosi.gov.sa](http://www.gosi.gov.sa)  
800 1243344



التأمينات الإلكترونية  
برامجك من ممتلكات

تعد هذه الشهادة من الوثائق الإلكترونية الحكومية الرسمية ، ويحظر قطعها تقليدها أو إدخال أي تعديلات عليها سواء بالإضافة أو الحذف أو التغيير في بياناتها أو غير ذلك من أنواع التعديل ، وتعد الشهادة لإغية إذا شلها شيء من ذلك ، كما تعرض صاحبها للملاحقة التظلمية أمام الجهات المختصة بالإضافة إلى مايفرضه نظام التأمينات الاجتماعية من عقوبات ، ولإيجوز تداول الشهادة إلا في الأغراض التي أصدرت لأجلها وفقا لأحكام نظام التأمينات الاجتماعية ، والمؤسسة العامة للتأمينات الاجتماعية غير مسؤولة عن أي أثار أخرى مترتبة قبل الغير عن الشهادة وغير مسؤولة عن أي عملية تزوير أو تعديل تتم على البيانات الواردة فيها .

ننهادة



# Riyadh Membership Certification



## شهادة اشتراك Membership Certificate

غرفة الرياض  
Riyadh Chamber

Membership No. :	78487	78487	رقم العضوية الموحد :
Date of Issue:	07/07/2014	2014/07/07	تاريخ الاصدار:
Membership Class :	Second	الثانية	درجة العضوية :
Riyadh Chamber Certifies			تشهد الغرفة التجارية الصناعية بالرياض بأن شركة خليج الخرسانة المحدودة
Commercial Registration No.	1010419075	1010419075	مقيدة بالسجل التجاري / الترخيص رقم :
Certificate Expires on	15/01/2027	2027/01/15	ينتهي سريان هذه الشهادة في



الخدمات الإلكترونية لغرفة الرياض - بوابة أعمال © E-Services Riyadh Chamber

920004565

- يلزم التحقق من الوثيقة عبر الرابط <https://mybusiness.chamber.sa> ، أو تطبيق (سند) للأجهزة المحمولة أو الرقم الموحد دون ادنى مسؤولية على الغرفة عن محتوى الوثيقة.
- تعد هذه الورقة من الوثائق الإلكترونية لغرفة الرياض، ويمنع تعديلها اول محاولة العبث بها وتصبح لاغية حال محاولة تعديلها وتعرض صاحبها للملاحقة القانونية.

# Monshaat Certification

منشآت  
monsha'at  
الهيئة العامة للمنشآت الصغيرة والمتوسطة  
Small Medium Enterprises General Authority

رقم الشهادة: 2227555681

اسم المنشأة: شركة خليج الخرسانة المحدودة تاريخ الإصدار: 28-05-2022

صلاحية الشهادة: سنة من تاريخ الإصدار \*

الرقم الوطني: 7001856652

السجل التجاري: 1010419075



تشهد الهيئة العامة للمنشآت الصغيرة والمتوسطة "منشآت" بأن المنشأة المذكورة أعلاه تدرج من ضمن المنشآت الصغيرة والمتوسطة وفقاً للتعريف المعتمد لدى "منشآت"

يتم التحقق من الشهادة من خلال موقع منشآت

<https://profile.monshaat.gov.sa/validate>

تعد هذه الشهادة من الوثائق الحكومية الرسمية، ولا يجوز تداولها أو استعمالها إلا في حدود الأغراض التي أصدرت لأجلها، ويحظر قطعياً تقليدها أو إدخال أي تعديلات عليها سواء بالإضافة أو الحذف أو التغيير في بياناتها أو غير ذلك من أنواع التعديل، وتعد هذه الشهادة لاغية إذا شابها شيء من ذلك، كما تعرض من ارتكب أي مما سبق إلى الملاحقة النظامية أمام الجهات المختصة دون الإخلال بما تنص عليه الأنظمة ذات العلاقة.

\* يجب التحقق من خلال رابط موقع منشآت عن صلاحية الشهادة حيث أنه يتم التحديث بشكل دوري

# Ministry Of Transport Certification



الموضوع: طلب تاهيل لاعمال فواصل التمدد بالجسور



المحترمين

السادة شركة خليج الخرسانة المحدودة  
( ٧٠٦٠ طريق الملك عبدالعزيز - المروج | الرياض ١٢٢٢٢ - ٤٥١٣ )

السلام عليكم ورحمة الله وبركاته

اشارة لخطابكم المقيد لدينا برقم ٥٩١٢٧ وتاريخ ١٤٤٢/٨/١٠هـ، واشارة لخطابكم المقيد لدينا برقم ١٦١٢٤ بتاريخ ١٤٤٢/٠٣/٠١هـ بخصوص طلب اعتماد وتأهيل شركتكم (شركة خليج الخرسانة المحدودة) كمقاول باطن بمشاريع تشغيل وصيانة ونظافة طرق المملكة بوزارة النقل، وبعد الإطلاع على المرفقات ودراسة الأوراق الثبوتية والجهاز الفني وخبرات الشركة وأعمالها السابقة، نفيديكم بأنه لا مانع لدينا من تأهيلكم كمقاول باطن معتمد لدى وزارة النقل لتنفيذ الأعمال الآتية:

1. تنفيذ وتركيب فواصل التمدد للجسور بأنواعها.
2. أعمال إصلاح وحماية الخرسانة وحقن ومعالجة الشروخ الانشائية وغير الانشائية.
3. تنفيذ أعمال العزل المائي والدهانات المضادة للكربنة (Anti-carbonation).
4. أعمال التدعيم باستخدام سرائح الكربون فايبر والقمصان المعدنية.
5. أعمال حقن التربة وتثبيت التربة بالخرسانة المقذوفة والخوازيق الأبرية.
6. أعمال الحماية الكاثودية للعناصر الانشائية.

وذلك اعتباراً من تاريخ خطابنا هذا ولمدة (سنة واحدة) شريطة إلتزامكم بالمواصفات العامة للوزارة، علماً أنه في حالة عدم إلتزامكم بالمواصفات فإنه سيتم وبدون سابق إنذار إلغاء اعتمادكم.

وتقبلوا أطيب تحياتي...

المملكة العربية السعودية  
Saudi Arabia  
Tel.+966118744444 / P.O.Box11178



مدير عام الإدارة العامة للصيانة  
تم اعتماد الخطاب إلكترونياً  
المهندس / عمر بن قربان نياز

« ص / مع التحية ل سعادة مدير ادارة صيانة المنشآت والجسور



المملكة العربية السعودية  
Saudi Arabia  
Tel.+966118744444 / P.O.Box11178





# ACCREDITATION CERTIFICATION



# Accreditation Certificate



شركة الأعمال التطويرية المحدودة  
Development Works Co. LTD

الرقم: 9320/ش/ع/2205  
التاريخ: 1443/10/22 هـ  
الموافق: 2022/05/23 م

## شهادة إنجاز أعمال

يسر شركة الأعمال التطويرية المحدودة أن تقدم شهادة إنجاز أعمال للمقاول شركة خليج الخرسانة لإنجازها تنفيذ أعمال التدعيم بنظام الألياف الكربونية في مشاريع المدارس التعليمية في المنطقة الشرقية والتابعة لوزارة التعليم ، حيث أنجز المقاول الأعمال في الوقت المحدد وطبقاً للمواصفات وبصفة مرضية .

وتفضلوا بقبول وافر الإحترام والتقدير ؟؟؟

المدير التنفيذي للمشاريع

م/عصام عاشور



شركة الأعمال التطويرية المحدودة  
Development Works Co.  
ص.ب. ١٠١٩٦٢٢٠

رأس المال ٧٥.٠٠٠.٠٠٠ ريال - سجل تجاري ١٠١٩٦٢٢٠ - العضوية: ١٤٤٣١ - ص.ب ٣٤١٥٣١ الرياض ١١٣٣٣ - هاتف: ٤٦٠٠٠١٦ (٩٦٦ ١١) - فاكس: ٤٦٠٩٣٥٦ (٩٦٦ ١١)  
Capital 75,000,000 SR - C.R. 1010196220 - C.C. 144310 - P.O. Box: 341531 - Riyadh 11333 - Tel. (+966 11) 4600016 - Fax: (+966 11) 4609356

١٤٤١/١١/١٣٩٥٩٤٩  
١٤٤١-٠٧-٠٦



السادة شركة ثبات للإنشاءات المحدودة  
المحترمين

ص.ب. (١٠٠٦٠٠) الرياض (١١٦٤٥) فاكس (٠١١-٢٧٨٣٢٩٠)

صورة للاستشاري تضامن مكتب أبا الخيل وشركة ويتفين ويوس  
المحترمين

ص.ب. (٤٠٧٤) الرياض (١١٤٩١) فاكس (٤٧٦٤٨٤١)

السلام عليكم ورحمة الله وبركاته

إشارة إلى عقد استكمال مشروع تصميم وتنفيذ محطة معالجة مياه الصرف الصحي بطريق الخرج المرحلة الثالثة بمدينة الرياض مقاولتكم، وإشارة إلى خطابكم رقم (P201190348-SUB-0019) وتاريخ ٢٠٢٠/٠٢/٠٢م (المرفق)، بخصوص طلبكم الموافقة علي اعتماد مقاول الباطن المقترح (شركة خليج الخرسانة المحدودة) لأعمال العزل المائي وأعمال إصلاح الخرسانة بالمشروع أعلاه.

أحيطكم بأنه لا مانع لدينا من اعتماد المقاول الباطن المقترح شركة خليج الخرسانة المحدودة (رقم التأميل 18158) للقيام بالأعمال المذكورة في المشروع أعلاه وتحت مسؤوليتكم الكاملة من حيث الأداء المرضي والسلامة في الموقع.  
مع أطيب تحياتي،،

مدير إدارة تنفيذ مشاريع الخدمات البيئية

م. عبد الله بن ظافر الدوسري

١٤٤١/ ٧/ ٦ هـ

www.nwc.com.sa

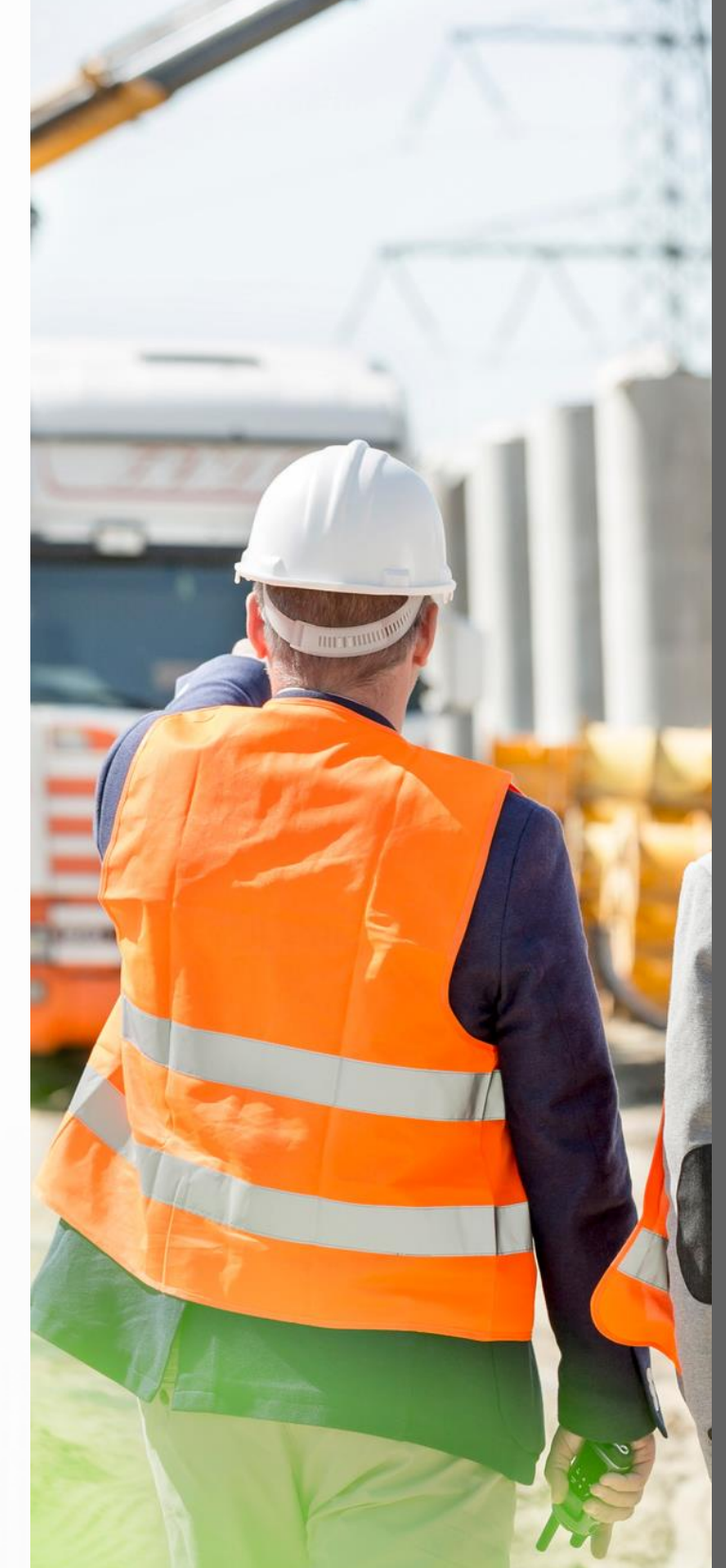



# Accreditation Certificate



June 19,  
2022

June 19,  
2022

To Whom It May  
Concern

This is to certify that M/S. GULF  
CRETE LTD. is one of our approved  
applicators covering the Kingdom of  
Saudi Arabia.

It may be noted that this certificate

does  
not cover or imply any responsibility  
liability for workmanships or failure of

the  
system. This certificate is issued upon  
request of applicator to Bitumat.

The certificate is non-exclusive and  
For Bitumat Company  
limited for period of one year from the date  
issue and to be renewed for further

period  
of one year.

Mr. Syed Abdullah Rizvi / سيد  
عبدالله اللهالهه رضوي  
Technical Advisor / مستشار تقني



Head Office : Dammam P.O. Box 7487 Zip Code : 31482 - K.S.A.  
Phone : +96613 8121210 / 8121213 Fax : +96613 8121190 Chamber of Comm : 1848  
Riyadh : P.O. Box 58698 Zip Code : 11515 Phone : 4770443 / 4792553 Fax : 4762318  
Jeddah : P.O. Box 12005 Zip Code : 21483 Phone : 6564449 / 6644868 Fax : 6564506  
Paid up Capital : SR 60,000,000 - C.R. : 2050014708 www.bitumat.com

شركة صناعات المواد العازلة للماء، ديرمابيت المحدودة  
DWI, DERMABIT Waterproofing Industries Co. Ltd.



Fully Paid up Capital S. R. 11.5 Million  
C. R. : 1010048740  
VAT No. 300534295800003  
RIYADH BRANCH : P. O. BOX 5945,  
RIYADH 11432 - SAUDI ARABIA  
TEL.: +966 11 464 5988 FAX : +966 11 463 4100  
Email : dermabit@dermabit.com  
Website : http://www.dermabit.com

رأس المال المدفوع بالكامل ١١.٥ مليون ريال سعودي  
سجل تجاري : ١٠١٠٠٤٨٧٤٠  
الرقم الضريبي : ٣٠٠٥٣٤٢٩٥٨٠٠٠٠٣  
فرع الرياض : ص ب ٥٩٤٥  
الرياض ١١٤٣٢ - المملكة العربية السعودية  
تلفون : +٩٦٦ ١١ ٤٦٣٤١٠٠ فاكس : +٩٦٦ ١١ ٤٦٤٥٩٨٨  
dermabit@dermabit.com  
http://www.dermabit.com

Date : 19/06/2022  
Ref.: 1910/22

التاريخ : ٢٠٢٢/٠٦/١٩ م  
الرقم : ١٩١٠/٢٢

TO WHOM IT MAY CONCERN

إلى من يهمه الأمر

We, DWI, Dermabit Waterproofing Industries  
Co., Ltd, 100% Saudi manufacturer of  
waterproofing systems, do hereby certify that  
M/S.GULF CRETE CONTRACTING. -  
Riyadh, have a good and an adequate  
experience for a long period in installing our  
waterproofing products in Saudi Arabia.  
They are one of our approved waterproofing  
contractors.

تشهد شركة صناعات المواد العازلة للماء ديرمابيت  
المحدودة شركة سعودية ١٠٠٪ ومنتجة لأنظمة العزل المائي  
البيتومينية بأن شركة خليج الخرسانة ومقرها الرياض هي  
متخصصة ومعتمدة في مجال تركيب أنظمة العزل المائي التي تنتجها  
شركة ديرمابيت لفترة طويلة ولديها خبرة جيدة ومناسبة لتنفيذ  
المشاريع داخل المملكة العربية السعودية.

This certificate does not imply any  
responsibility on our part for quality control  
of workmanship or any contractual  
liabilities.

اعطيت هذه الشهادة بناء على طلبهم دون أدنى مسؤولية على  
شركة ديرمابيت فيما يتعلق بأي اضرار مترتبة على عيوب قد تنشأ  
عن اخطاء في تركيب المنتجات وخلافه.

Validity of this certificate is for one year  
from the above mentioned date and is  
subject to Dermabit's regular and annual  
evaluation.

صلاحية هذه الشهادة لمدة عام واحد من تاريخه وتخضع  
للتقييم السنوي المعتاد.

Best regards,

DWI, DERMABIT WATERPROOFING  
INDUSTRIES CO., LTD

MARWAN KULLAB  
Asst. sales Manager

شركة صناعات المواد العازلة للماء  
ديرمابيت المحدودة  
فرع الرياض - رقم الضريبة : ٣٠٠٥٣٤٢٩٥٨  
DWI, Dermabit Waterproofing  
Industries Co. Ltd.  
Riyadh Branch - C.C. 32167



المكتب الرئيسي : ص ب ١٠٣٠٨ مدينة الجبيل الصناعية ٣١٩٦١ المملكة العربية السعودية تلفون : +٩٦٦ ١٣ ٣٤١٠٤٦٤ فاكس : +٩٦٦ ١٣ ٣٤١٠٤٨١ ص ب : ٣٠٥٠٠١٠٢٤  
HEAD OFFICE : P. O. BOX 10308, JUBAIL INDUSTRIAL CITY 31961 SAUDI ARABIA TEL.: +966 13 3410464 FAX : +966 13 3410481 C.R.: 2055001024





# Accreditation certificate

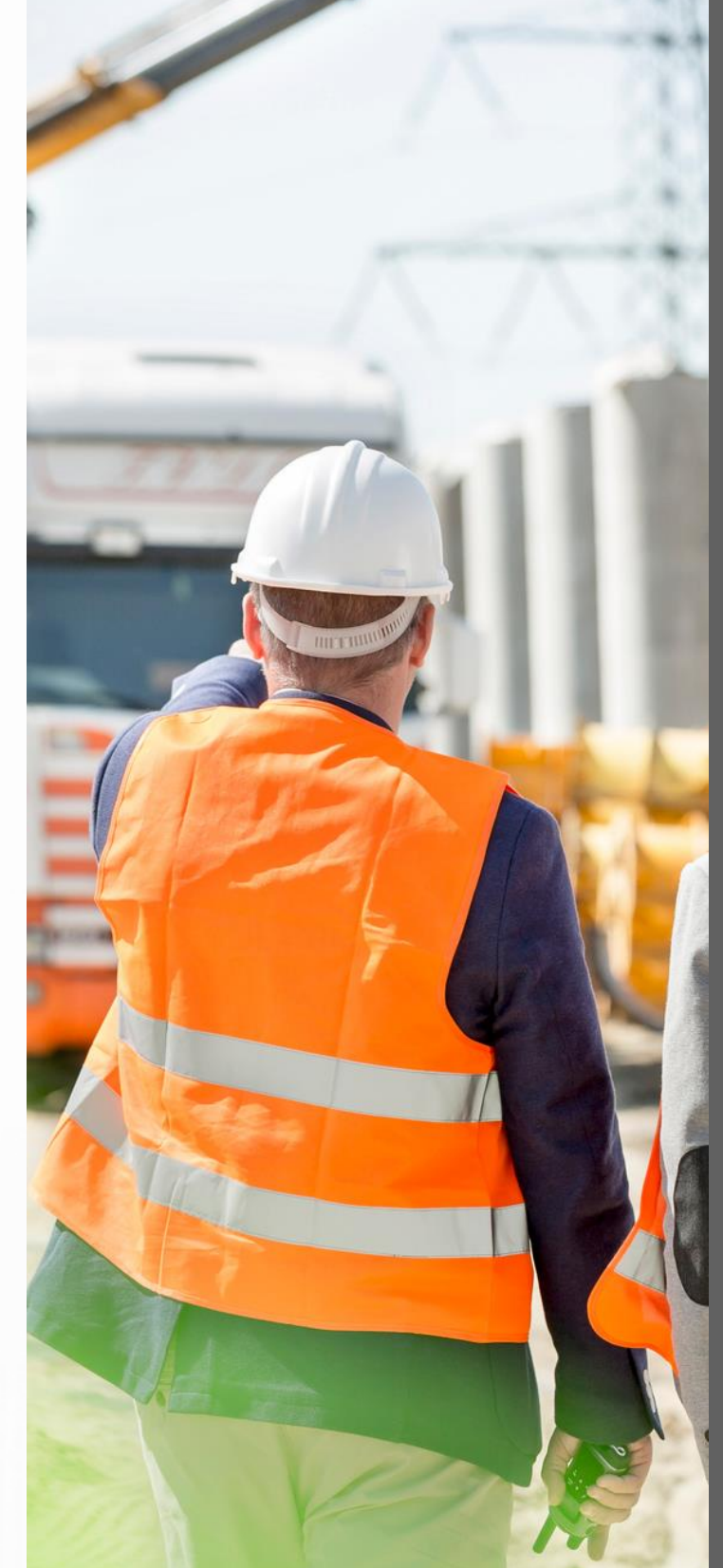

CERTIFICATION

# Accreditation Certificate

## CERTIFICATION

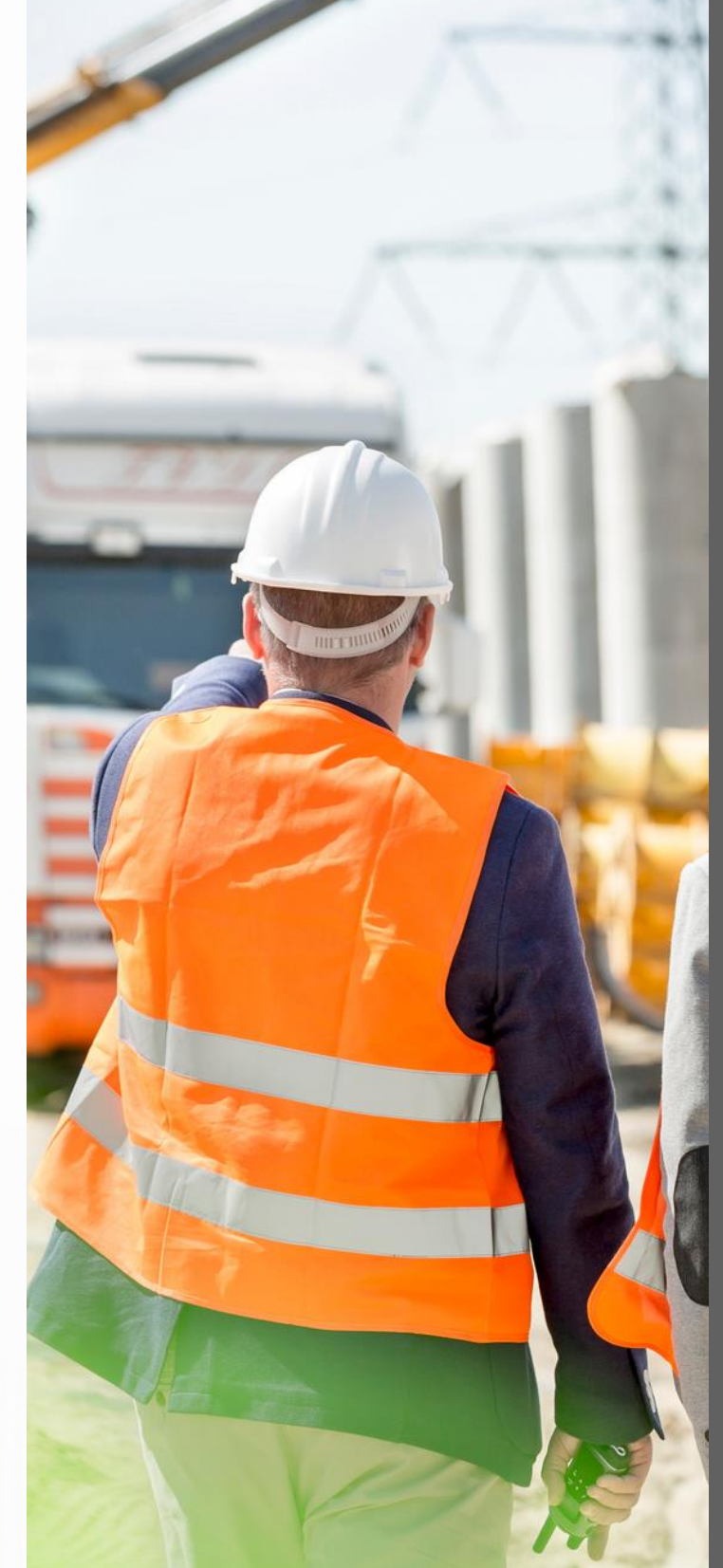

# Accreditation Certificate

**dun & bradstreet**  
D-U-N-S Number® Certificate

This is to certify that

**GULF CRETE LTD**

Building 40 & Office 23,  
Al Urubah Street,  
Riyadh,  
Saudi Arabia

is now part of the  
Dun & Bradstreet Global Database

**D&B D-U-N-S Number®**  
**55-784-9513**



R Suryanarayan  
General Manager Africa  
Dun & Bradstreet South Asia Middle East Limited

January 9, 2017

 Dun & Bradstreet South Asia Middle East Ltd.

**ISOLATEK**  
INTERNATIONAL

**GREEN TECH**  
THERMAL INSULATION PRODUCTS MFG. LLC  
جرين تك لصناعة مواد العزل الحراري  
Factory: P.O. Box: 3343, Umm Al Quwain, U.A.E  
Tel: +971 6 767 2327  
Sales Office: Business Bay, Dubai, U.A.E  
Tel: +971 4 352 6210

Date: 01 January 2010

**TO WHOM IT MAY CONCERN**

**Re: Recognized Applicator Certificate**

This letter is to confirm that **M/S GULF CRETE LTD**  
**P.O. BOX 28593**  
**RIYADH - 11323**  
**KINGDOM OF SAUDI ARABIA.**

has been identified as a Recognized Applicator for ISOLATEK Fireproofing Systems: ISOLATEK TYPE MII High Density SFRM.

ISOLATEK/GREENTECH operates a global network of Recognized Applicators, all of whom have been instructed in the application techniques of individual products, have been issued with on-site Application Guidelines and received regular updates of such guidelines.

In the event that **M/S GULF CRETE LTD** secures Fireproofing contracts for ISOLATEK Products and Systems, ISOLATEK/GREENTECH will ensure that the installation will be completed in accordance with the recognized practices.

Our standard of re-validation is every 3 years from the date of issue.

Yours Sincerely,

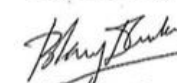

**Blány D' Cunha**  
Managing Director Sales  
Greentech Thermal Insulation Products Mfg. LLC



[www.isolatek.com](http://www.isolatek.com) | [technical@greentech-isolatek.com](mailto:technical@greentech-isolatek.com)  
Greentech is an Authorized and Licensed Manufacturer & Supplier of Isolatek International Fireproofing

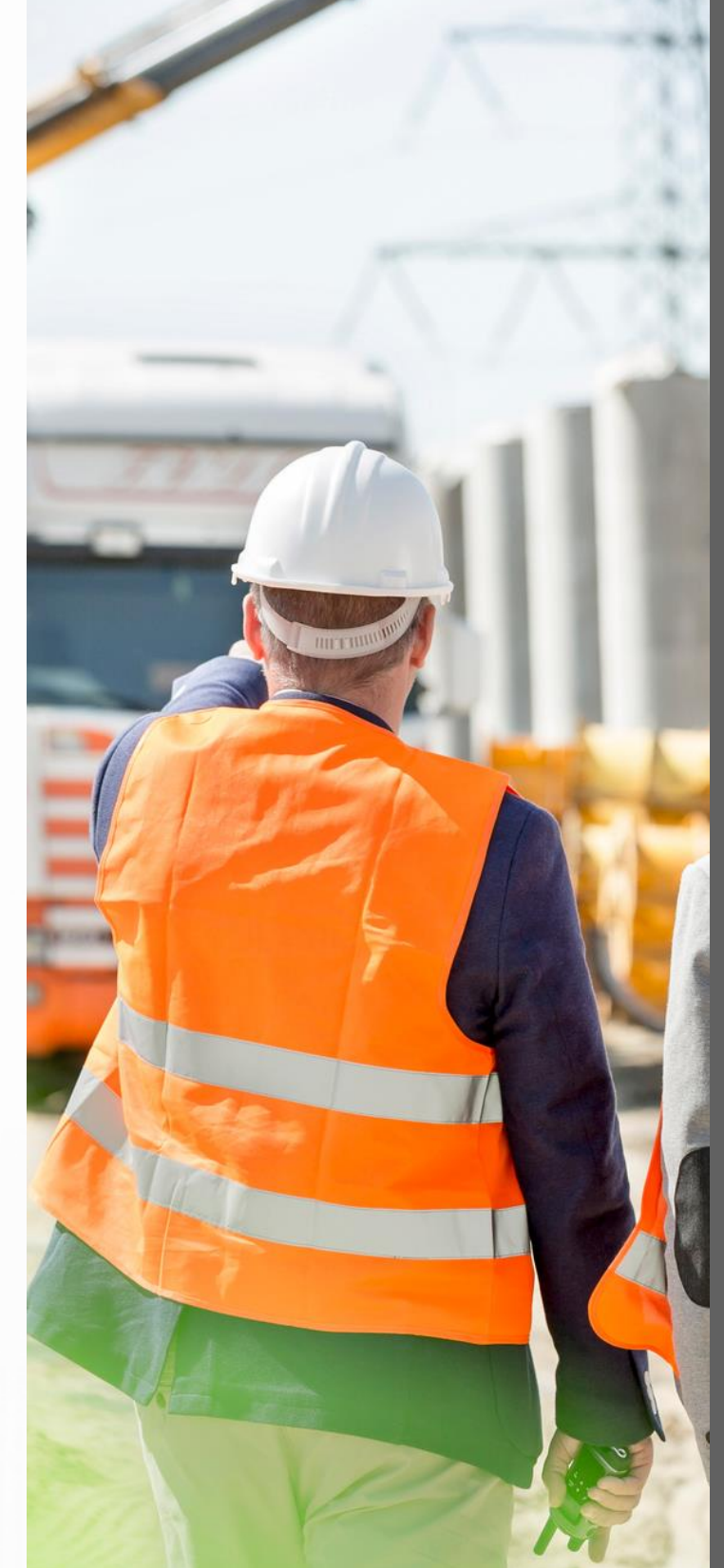

# Accreditation Certificate



## To Whom it May Concern

Subject: Gulf Crete Vendor IDs Details

Sr#	Vendor ID	Client Name	Status
01	VDR56807	The Red Sea Global	Active
02	1100001590	Neom	Active
03	S10145449	Qiddiya	Active
04	10060363	Aramco	Active
05	5017966	Saudi Electricity Co	Active
06	11045363	Sabic	Sabic Supplier Portal was migrated to SAP ARIBA the new Vendor ID is under process.
07	18158	NWC	Active
08	1002234	SWCC	Active
09	094-01731	Nesma	Active
10	3187	Saudi Railway	Active
11		Gaca	Active
12	2900851	Royal Commission	Active
13	4828	El Seif	Active

Prepared By: Gulf Crete Ltd D.C

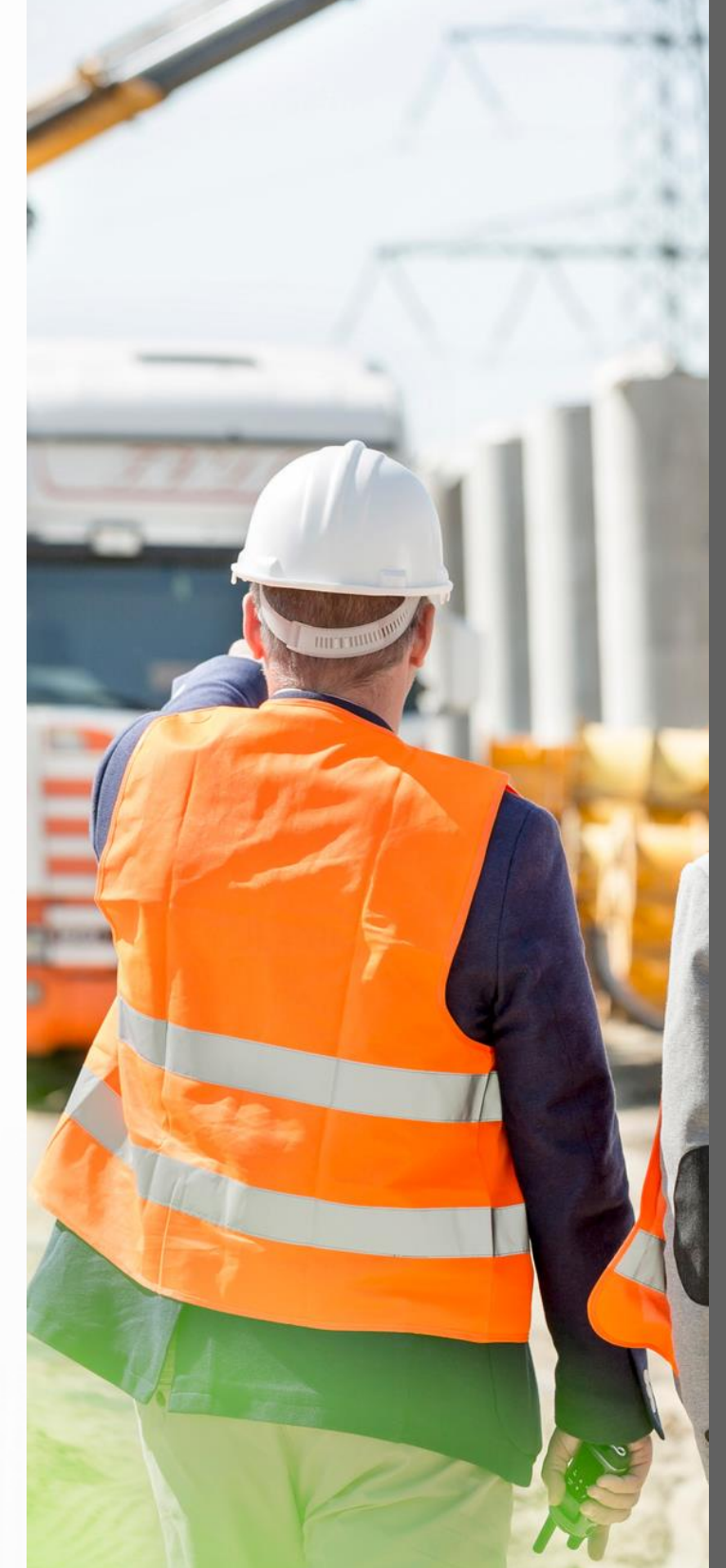



# WORK CERTIFICATION



MAIL TYPE: Workflow Transmittal  
 MAIL NUMBER: BEC-WTRAN-057428  
 REFERENCE NUMBER: BEC-WTRAN-057428

**Final (WF-044603) 07-184000-1100001342-MAG-CPM-PQD-000004\_WO 031 - NEOM Trojena – Construction of Early Works Permanent Roads – Discover, Explore and Villages Pre-Qualification Documents of Gulf Crete Ltd for Rock Fall/Mesh**

From: Mr Hamada Fathalla - Bechtel KSA  
 To (3): Bechtel Document Management TROJENA - Bechtel KSA, Mr Hamada Fathalla - Bechtel KSA, 1100001342DCC MASCO - MASCO  
 Cc (3): Mr Mohit Jain - Bechtel KSA, Mr Mostafa Darwish - Bechtel KSA, NEOM Trojena Document Control - NEOM - Projects  
 Sent: Saturday, December 30, 2023 8:16:39 AM AST (GMT +03:00)  
 Status: N/A

**DOCUMENT ATTACHMENTS (2)**

(0 selected)

File	Document No	Revision	Revision Date	Title	Status
	07-184000-1100001342-MAG-CPM-CRS-000004	01	12/7/23	WO 031 - NEOM Trojena – Construction of Early Works Permanent Roads – Discover, Explore and Villages Pre-Qualification Documents of Gulf Crete Ltd for Rock Fall/Mesh	A - Work May Proceed
	07-184000-1100001342-MAG-CPM-PQD-000004	01	12/7/23	WO 031 - NEOM Trojena – Construction of Early Works Permanent Roads – Discover, Explore and Villages Pre-Qualification Documents of Gulf Crete Ltd for Rock Fall/Mesh	A - Work May Proceed

**MESSAGE**

**Workflow Review History**

The attached documents have completed the "07-184000-1100001342-MAG-CPM-PQD-000004\_WO 031 - NEOM Trojena – Construction of Early Works Permanent Roads – Discover, Explore and Villages Pre-Qualification Documents of Gulf Crete Ltd for Rock Fall/Mesh" workflow with the following results :

*This transmittal was automatically generated.*

Doc No	Step	Participant	Review Outcome	Comments
07-184000-1100001342-MAG-CPM-PQD-000004	PMC DCC	H Fathalla	A - Work May Proceed	
07-184000-1100001342-MAG-CPM-CRS-000004	PMC DCC	H Fathalla	A - Work May Proceed	





Document Title: DOCUMENT SUBMISSION FORM (DSF)		Project Contractor: Gulf Builder			
Project Name: INFRASTRUCTURE, AND NETWORKS-84 RBF IN DAMMAN-2		Project Consultant: Worley			
Project Number: DAM2-01-010		Document Reference No: DAM2-02-010-GB-TS9-3-DSF-CVL-000014-00			
<b>CIVIL &amp; STRUCTURAL</b>					
DOCUMENT ISSUED BY		DOCUMENT RECEIVED BY			
Issued By: Engr Ahmed Abdel Fatah	Position/Company: Project Manager	Received By: SULIMAN NOJYFAN	Position/Company: D.C.		
Signature: [Signature]	Date: 11-02-2020	Signature: [Signature]	Date: 11/02/2020		
<b>ATTACHMENTS</b>					
source	Manufacturer	Bill of Quantities			
Certification	Manual	Method Statement			
✓ Sub-contractor	✓ Pre-qualification	Technical Information			
Engineering Calculation	Procedure/ Methodology	Bank Warranty			
Job Order	Product Data	Letter			
Sample	Test Report	Shop drawings			
<b>PURPOSE FOR DOCUMENT SUBMISSION</b>					
FOR INFORMATION	FOR REVIEW & APPROVAL	AS REQUESTED	OTHER (As Noted)		
<input type="checkbox"/>	<input type="checkbox"/>	<input type="checkbox"/>	<input type="checkbox"/>		
<b>SUBMITTED DOCUMENTS REFERENCE NUMBERS</b>					
#	Document Reference No.	Document Description	Rev.	Hard Copy	Soft Copy
1	GULF CRETE LTD.	Contractor for Water proofing and Insulation Work	00		✓
2					
<b>RESPONSE STATUS</b>					
APPROVED AS SUBMITTED (APP)	<input checked="" type="checkbox"/>	APPROVED AS NOTED (APN)	<input type="checkbox"/>	REJECTED/RE-SUBMIT (RRS)	<input type="checkbox"/>
<b>COMMENTS</b>					
* The Subcontractor is approved for the water proofing and insulation works only. 13/02/20					
RESPONSE ISSUED BY			RESPONSE RECEIVED BY		
Issued By: Bassam Saad	Position/Company: CM	Received By: [Signature]	Position/Company: [Signature]	Signature: [Signature]	Date: 13/02/20
Signature: [Signature]	Date: 13/02/20	Signature: [Signature]	Date: [Signature]	Date: [Signature]	Date: [Signature]
Note: Approval by the consultant shall not release the contractor of its obligations and liabilities under the contract in case of any discrepancy between the inspected works and final approved designs, the contractor shall carry out the necessary remedies, rectifications, demolition and reconstruction according to the final approved design without the right to claim extra cost and time					

ألومنيوم  
Aluminium

الغريير للإنشاءات  
Al Ghurair Construction

شهادة انجاز

بهذا تشهد شركة الغريير للإنشاءات والالومنيوم بأن شركة خليج الخرسانة , قد قامت بتنفيذ مشروع عزل اسقف محطات الباصات الخاصة بمشروع الملك عبدالعزيز للنقل العام لجميع المحطات والجسور بالمشروع المرحلة الثالثة في مدينة الرياض , (TPO waterproofing membrane System with Rockwool, Glass Board And corrugated metal Sheet)

كما تشهد شركة الغريير للإنشاءات بان شركة خليج الخرسانة قد أوفت بكافة التزاماتها الخاصة بهذا المشروع بكفاءة ووفقا للجدول الزمني المحدد لها وبصفة مرضيه .

وقد اعطيت هذه الشهادة لشركة خليج الخرسانة كشهادة انجاز لاعمال المشروع بنجاح.

التوقيع  
فهد شيخة AP

شركة الغريير للإنشاءات والالومنيوم العربية  
Al Ghurair Construction & Arabian Aluminium LLC

شركة الغريير للإنشاءات والالومنيوم العربية د.م.  
P.O. Box 259223, P. Code 11351  
Al Riyadh, Saudi Arabia  
T +966 1 4629200  
F +966 1 4640092  
www.al-ghurair.com







23, 9:07 AM Aconex

Bechtel Document Management Final (WF-085561) WO 045 - Spine Earthworks Lot 10-2 ... 8:53 AM  
 Bechtel KSA WORKFLOW TRANSMITTAL BEC-WTRAN-177461

---

10 Spine Infrastructure  
 Spine Infrastructure  
 NEOM  
 Saudi Arabia



MAIL TYPE	MAIL NUMBER	REFERENCE NUMBER
Workflow Transmittal	BEC-WTRAN-177461	BEC-WTRAN-177461

**Final (WF-085561) WO 045 - Spine Earthworks Lot 10-2 Ch 73+500 To Ch 75+500 (Coastal Desert Region) - Pre-Qualification Document for GULF CRETE LTD. CONTRACTING COMPANY for Application of Shotcrete**

From: Bechtel Document Management - Bechtel KSA



To (2): Bechtel Document Management - Bechtel KSA (+1 more...)

Cc (2): NEOM Quality & Excellence Document Control - NEOM - Engineering & Technical Services Dept (+1 more...)

Sent: Wednesday, 8 February 2023 8:53:15 AM AST (GMT +03:00)

Status: N/A

**DOCUMENT ATTACHMENTS (2)**

File	Document No	Revision	Revision Date	Title	Status
	10-603172-0000100201-MAH-CIV-CRS-000068	03	30/01/2023	WO 045 - Spine Earthworks Lot 10-2 Ch 73+500 To Ch 75+500 (Coastal Desert Region) - Pre-Qualification Document for GULF CRETE LTD. CONTRACTING COMPANY for Application of Shotcrete_CRS	A - Work May Proceed
	10-603172-0000100201-MAH-CIV-PQD-000018	03	30/01/2023	WO 045 - Spine Earthworks Lot 10-2 Ch 73+500 To Ch 75+500 (Coastal Desert Region) - Pre-Qualification Document for GULF CRETE LTD. CONTRACTING COMPANY for Application of Shotcrete	A - Work May Proceed

**MESSAGE**

**Workflow Review History**

The attached documents have completed the "WO 045 - Spine Earthworks Lot 10-2 Ch 73+500 To Ch 75+500 (Coastal Desert Region) - Pre-Qualification Document for GULF CRETE LTD. CONTRACTING COMPANY for Application of Shotcrete" workflow with the following results :

[s://ksa1.aconex.com/hub/index.html?mainTarget=%2FViewCorrespondence%3FCorrespondence\\_ID%3D1358337652%26CORRESPONDENCE\\_...](https://ksa1.aconex.com/hub/index.html?mainTarget=%2FViewCorrespondence%3FCorrespondence_ID%3D1358337652%26CORRESPONDENCE_...) 1/2

12/20/21, 9:52 AM https://ksa1.aconex.com/rsrc/20211215.0853/en\_AU\_DOC/mail/view/index.html#/1342178863/1351631040?attachedMailParentl...

10 Spine Infrastructure  
 Spine Infrastructure  
 NEOM  
 Saudi Arabia



MAIL TYPE	MAIL NUMBER	REFERENCE NUMBER
RFI Circulation Response	ACM-RRFI-000016	CRC-RFI-000018

**Re: TQ-22A-Technical Clarification on replied TQ-022 Rockfall Fence**

From: Mr Stoney Mather - AECOM

To (3): Mr Stephen Purdue - AECOM (+2 more...)

Cc: Alexander Donald Mackay - Bechtel KSA

Sent: Monday, 20 December 2021

**MESSAGE**

Gentlemen,

In regard to rock fencing, specification 10-136000-0000100595-ACM-TNL-SPC-000009 SECTION 313326 -- ROCK SLOPE WIRE MESH, PART 1 GENERAL, Section 1.1 B.2 and B.4 state:

2. Complete the Detailed Design, manufacture, supply, install and warrant the work, complying with the specified design and performance requirements."

4. Where a particular material, product or supplier is specified, the material, product or supplier shall be deemed indicative representing the Employer's Representative's Design Intent only. Complete the installation using the specified or other product acceptable to the Employer's Representative. Be fully responsible for the Detailed Design and performance of the work.

Also, Section 2.2 indicates: "Rockfall wire mesh shall be flexible nominal TECCO G65/3 high tensile mesh or similar. Components shall have Geobrugg "Ultracoat" corrosion protection or similar corrosion protection and shall not be coated PVC." And IFC plan sheet 10-136000-0000100595-ACM-TNL-DRG-500061 includes an indicative arrangement for rockfall fencing and states: "ROCKFALL FENCE GEOBRUGG GBE-3000A 6m HIGH 3000 kJ CAPACITY OR SIMILAR APPROVED. ROCKFALL FENCE DETAILS AND INSTALLATION TO BE IN ACCORDANCE WITH MANUFACTURER'S REQUIREMENTS" and "LOCATION, ARRANGEMENT, SIZE AND CAPACITY MAY VARY IN RESPONSE TO ROCK SLOPE MAPPING."

**Accordingly, the contractor may use G80/4 wire mesh in compliance with the manufacturer's recommendation to achieve the performance requirements (3000kJ) for the rockfall protection system that the contractor has designed, will install, and will warrant.**

Thanks.

---

From: R Kyte  
 Sent: 12/20/21 8:36:50 AM AST (GMT +03:00)  
 To: Jeremy Cox, Stoney Mather, Stephen Purdue  
 Mail Number: BEC-RFIC-000693  
 Subject: Fwd: TQ-22A-Technical Clarification on replied TQ-022 Rockfall Fence

Stephen

[https://ksa1.aconex.com/rsrc/20211215.0853/en\\_AU\\_DOC/mail/view/index.html#/1342178863/1351631040?attachedMailParentId=1351631860](https://ksa1.aconex.com/rsrc/20211215.0853/en_AU_DOC/mail/view/index.html#/1342178863/1351631040?attachedMailParentId=1351631860) 1/4





11/7/21, 9:51 AM

Aconex

Bechtel Document Management  
BECHTEL KSA

Final (WF-014107) 10-136000-4800000241-CRC-CIV-M... 31/10/2021  
WORKFLOW TRANSMITTAL BEC-WTRAN-022701

10 Spine Infrastructure  
Spine Infrastructure  
NEOM  
Saudi Arabia



MAIL TYPE  
Workflow Transmittal

MAIL NUMBER  
BEC-WTRAN-022701

REFERENCE NUMBER  
BEC-WTRAN-022701

Final (WF-014107) 10-136000-4800000241-CRC-CIV-MAT-000019\_Material Submittal for Rockfall Protection Barrier by Gebrugg

From Bechtel Document Management - Bechtel KSA  
To (2) Bechtel Document Management - Bechtel KSA (+1 more...)  
Cc (6) Colin Watson - Bechtel KSA (+5 more...)  
Sent Sunday, 31 October 2021 2:11:11 PM AST (GMT +03:00)  
Status N/A

DOCUMENT ATTACHMENTS (2)

File	Document No	Revision	Revision Date	Title	Status
	10-136000-4800000241-CRC-CIV-CRS-000049	01	23/10/2021	Material Submittal for Rockfall Protection Barrier by Gebrugg_CRS	B - Incorporate Comments - Proceed
	10-136000-4800000241-CRC-CIV-MAT-000019	01	23/10/2021	Material Submittal for Rockfall Protection Barrier by Gebrugg	B - Incorporate Comments - Proceed

MESSAGE

Workflow Review History

The attached documents have completed the "10-136000-4800000241-CRC-CIV-MAT-000019\_Material Submittal for Rockfall Protection Barrier by Gebrugg" workflow with the following results :

*This transmittal was automatically generated.*

Doc No	Step	Participant	Review Outcome	Comments
14-662000-4800000322-	NEOM/AECOM_Review	K Mekhimer	B - Incorporate Comments	Refer to CRS & PDF

<https://ksa1.aconex.com/Logon>

1/2

Khali Mekhimer  
AECOM

Final (WF-028196) 14-4800000322/000-IN-Project Mana... 28/07/2022  
WORKFLOW TRANSMITTAL ACM-WTRAN-055262

14 Outer Regions  
Riyadh, KSA  
Riyadh  
Saudi Arabia



MAIL TYPE  
Workflow Transmittal

MAIL NUMBER  
ACM-WTRAN-055262

REFERENCE NUMBER  
ACM-WTRAN-055262

Final (WF-028196) 14-4800000322/000-IN-Project Management - IFR (PQD)

From Mr Khalil Mekhimer - AECOM  
To (2) Mr Khalil Mekhimer - AECOM (+1 more...)  
Cc (9) Khaled Ismail - AECOM (+8 more...)  
Sent Thursday, 28 July 2022 11:20:53 AM AST (GMT +03:00)  
Status N/A

DOCUMENT ATTACHMENTS (2)

File	Document No	Revision	Revision Date	Title	Status
	14-662000-4800000322-MOB-CIV-CRS-000225	01	07/07/2022	4800000322/000 - Prequalification Of GCL For Fire Paint	B - Incorporate Comments - Proceed
	14-662000-4800000322-MOB-CIV-PQD-000053	01	07/07/2022	4800000322/000 - Prequalification Of GCL For Fire Paint	B - Incorporate Comments - Proceed

MESSAGE

Workflow Review History

The attached documents have completed the "14-4800000322/000-IN-Project Management - IFR (PQD)" workflow with the following results :

*This transmittal was automatically generated.*

Doc No	Step	Participant	Review Outcome	Comments
14-662000-4800000322-	NEOM/AECOM_Review	K Mekhimer	B - Incorporate Comments	Refer to CRS & PDF





Doc No: DG-DSQ-316-0000-SSA-PQQ-PR-000188  
 Revision: 00  
 Date: 18 August 2022  
 Page: 1 of 2



## (DRF) Document Review Form (Submittal)

### Part 1 – Issue / Receive / Distribute

Employer: Diriyah Gate Development Authority  
 Contractor: Salini Saudi Arabia  
 Project: DSQ Package 2 – Super Basement  
 Contract/ Work Package: DD-2020-249 / DSQ 316  
 Construction Supervisor: AECOM Arabia

Document Type	Document Reference
PREQUALIFICATION	DG-DSQ-316-0000-SSA-PQQ-PR-000188(00)

Document Description	
Title	PREQUALIFICATION- Subcontractor for Epoxy Coating Applicator (Subcon: Gulf Crete Ltd)
Package:	DSQ Package 2
Discipline:	Procurement
Work Location:	Package 2 super basement

List of Attachments (If Any)	

Issued By: Contractor

Name:	Marco Tentorio	Date:	18 August 2022
Role:	Contractor's Representative		
Signature & Stamp:			



### Document Submittal

Project Name:	RUA AL MADINAH PROJECT MAIN INFRASTRUCTURE PACKAGE		
Contractor:	Al Ajmi & CR18G	Contractor Ref #:	MIP-JVC-PQD-CIV-000093-00
PMC:	Parsons	TSC:	WSP
Location:	Al-Madinah	Date:	21-Mar-23

Please check appropriate box:

<input type="checkbox"/> Letter	<input type="checkbox"/> Technical Report	<input type="checkbox"/> Shop Drawing
<input type="checkbox"/> Technical Submittal	<input type="checkbox"/> GIS or CAD	<input type="checkbox"/> Reports
<input type="checkbox"/> Bill of Quantities	<input type="checkbox"/> Material Approval	<input type="checkbox"/> Test Reports
<input type="checkbox"/> Procedure or Methodology	<input type="checkbox"/> Engineering Calculation	<input type="checkbox"/> Permissions
<input type="checkbox"/> PM Plan	<input type="checkbox"/> Program	<input type="checkbox"/> Manuals
<input type="checkbox"/> Product Data	<input type="checkbox"/> As Built	<input type="checkbox"/> Others (please specify)
<input checked="" type="checkbox"/> Pre-qualification	<input type="checkbox"/> Certificates	
<input type="checkbox"/> Material Sample	<input type="checkbox"/> Drawings	

Purpose:  For Information  For Review & Approval  As Requested

Subject: Prequalification for Company Gulf Crete Ltd as a Sub Contractor for water proofing work.

#### Document Description:

SR. No.	Document No.	BoQ #	Document Name	Rev.	Hard Copy	Soft Copy
1	MIP-JVC-PQD-CIV-000093-00		Prequalification for Company Gulf Crete Ltd as a Sub Contractor for water proofing work.	00		✓
2						
3						

Contractor PM: Name: Ahmed Roshdy Date: 21-Mar-23 Signature: Stamp



WSP Review & Approval Status <input type="checkbox"/> A - Approved (Work may proceed) <input checked="" type="checkbox"/> B - Approved as Noted (Work may proceed subject to Incorporation of Comments) <input type="checkbox"/> C - Revise and Resubmit (Work may not proceed) <input type="checkbox"/> D - Rejected <input type="checkbox"/> E - For Information	Discipline Engineer / QA-QC Manager Name: Mohamed Samy Eleissawy Sign: Date: 27 Mar
---	--

Comments:  
 1-Gulf Crete Ltd as a Sub Contractor for waterproofing work has to provide/update the missing Docs, according to the attached checklist prior to starting any activity.  
 2-Waterproofing installation MOS with warranty certificate draft has to be submitted by Gulf Crete Ltd as a Sub Contractor for review and approval.  
 3-The Gulf Crete Ltd has to provide an approval certificate for application of the system from the waterproofing manufacturer.  
 4-The organization chart of the assigned qualified staff on the project has to be submitted for review and approval

WSP Resident Engineer  
 Name: Mohamed Salama Sign: Date: 27/03/2023  
 Mahmoud Abbas





### MATERIAL APPROVAL REQUEST

Project:	Construction of the water transmission line and water Reservoir – Riyadh, Sedra2	Ref No.:	00102-AST-REQ-MR-00276
Client:	ROSHN	Rev. No.:	1
Engineer:	SAPL	Submittal:	CMI Date: 9/7/2023
Contractor:	ASTRA Construction	Purpose/Use:	

MATERIAL DESCRIPTION			
Description	Material submittal for light weight concrete to roof (foam concrete)	Brand Name:	MAS Foam cement
Material Status:	<input checked="" type="checkbox"/> Specified <input type="checkbox"/> Alternative	Contract Ref:	
Reason for the Change if any			
Discipline/Trade	Civil	Specification:	
Project Name.:	Building:	BOQ Ref. No.:	
Attachments:	<input checked="" type="checkbox"/> Production Verification <input type="checkbox"/> Sample <input checked="" type="checkbox"/> Comparison Sheet <input type="checkbox"/> List of Suppliers <input type="checkbox"/> Third Party Test Report <input type="checkbox"/> Catalogue <input type="checkbox"/> Previous Approval <input checked="" type="checkbox"/> Others (Data Sheet)		

MANUFACTURER DETAILS	SUPPLIER DETAILS
Company Name: MAS paints	Company Name: Gulf Crete
Address: KSA	Address: KSA

DELIVERY DETAILS			
Country of Origin:	Availability:	<input type="checkbox"/> Locally Available <input type="checkbox"/> Imported	
Date Material Required on Site:	Estimated Date of Arrival on Site:		
<small>We certify that the above submitted items are correct and in strict conformity with the contract drawings and specifications except otherwise stated; also the material sources indicated above have been checked to verify the submitted items in full conformity with timely delivery.</small>			
For the Contractor:	Contractor Stamp		
Name: Sufian Obaid	Signature:	Date: 9-7-2023	

ENGINEER'S REVIEW	
Remarks: 1. This approval based on manufacturer recommendation and warranty certificate. Contractor is responsible to submit the warranty certificate after completion of work with company stamp and signature. 2. Contractor shall arrange mock up and kick of meeting before start activity.	
Is Employer's Approval required	<input type="checkbox"/> Yes <input checked="" type="checkbox"/> No
Name: GHULAM DASTAGEER	Signature:  Date: 10-JULY-2023
Status Code:	<input type="checkbox"/> Approved (A) <input checked="" type="checkbox"/> Approved with Comments (B) <input type="checkbox"/> Revise & Resubmit (C) <input type="checkbox"/> Rejected (D)

PM (CORE TEAM) REVIEW	
Remarks: Contractor shall follow Engineer's comments that comply with contract conditions	
Name: Abdulrah khraisat	Signature:  Date: 10-July-23
Cost & Time Impact (For Alternative Material)	
Cost	<input type="checkbox"/> Increase <input type="checkbox"/> Decrease Amount (SAR):
Time	<input type="checkbox"/> Increase <input type="checkbox"/> Decrease Days:

CLIENT'S APPROVAL (Optional)	
Remarks:	
Name:	Signature: Date:

Approval shall not relieve the Contractor of its obligations and liabilities under the Contract or constitute authorization of any change to Contract Documents, and therefore, shall not imply on recognition whatsoever of additional time or cost to the Contract

12/8/22, 4:35 PM
Aconex

Muhammad Jamali  
SAUDI ARABIAN PARSONS LIMITED
Final (WF-004947) (Astra) Transmission Line-Submittal fo...  
WORKFLOW TRANSMITTAL
3:58 PM  
SAPL-WTRAN-007430



MAIL TYPE	MAIL NUMBER	REFERENCE NUMBER
Workflow Transmittal	SAPL-WTRAN-007430	SAPL-WTRAN-007430

#### Final (WF-004947) (Astra) Transmission Line-Submittal for Approval (ARC) 00102-AST-REQ-MR-00128 R1- Material Submittal for Water Proofing System

From: Mr Muhammad Jamali - SAUDI ARABIAN PARSONS LIMITED

To (3): Mr Yousuff Shaik - SAUDI ARABIAN PARSONS LIMITED (+2 more...)

Cc (13): Saleh Almarshad - ROSHN Real Estate (+12 more...)

Sent: Thursday, 8 December 2022 3:58:29 PM AST (GMT +03:00)

Status: N/A

DOCUMENT ATTACHMENTS (1)

File	Document No	Revision	Revision Date	Title	Status
	00102-AST-REQ-MR-00128	01	30/11/2022	Material Submittal for Water Proofing System	B - Approved with Comments

MESSAGE

Workflow Review History

The attached documents have completed the "(Astra) Transmission Line-Submittal for Approval (ARC) 00102-AST-REQ-MR-00128 R1- Material Submittal for Water Proofing System" workflow with the following results :

This transmittal was automatically generated.

Doc No	Step	Participant	Review Outcome	Comments
00102-AST-REQ-MR-00128	Saudi Parsons	M Jamali	B - Approved with Comments	Please check on the attachment

https://ksa1.aconex.com/hub/index.html?mainTarget=%2FViewCorrespondence%3FCorrespondence\_ID%3D1356984828%26CORRESPONDENCE\_... 1/1





11/5/22, 9:45 AM

Aconex

AbdulAleem Mohammed  
SAUDI ARABIAN PARSONS LIMITED

Final (WF-003266) (Astra) Transmission Line-Submittal fo...  
WORKFLOW TRANSMITTAL  
SAPL-WTRAN-004780

9:27 AM  
SAPL-WTRAN-004780



ROSHN



شركة پارسونز العربية السعودية المحدودة

MAIL TYPE: Workflow Transmittal  
MAIL NUMBER: SAPL-WTRAN-004780  
REFERENCE NUMBER: SAPL-WTRAN-004780

**Final (WF-003266) (Astra) Transmission Line-Submittal for Approval (ARC)00102-AST-REQ-MR-00116 -Prequalification documents for Water Proofing System (Tanking , Wet Area , Roofing)**

From: Mr AbdulAleem Mohammed - SAUDI ARABIAN PARSONS LIMITED  
To (3): Mr AbdulAleem Mohammed - SAUDI ARABIAN PARSONS LIMITED (+2 more...)  
Cc (13): Saleh Almarshad - ROSHN Real Estate (+12 more...)  
Sent: Saturday, 5 November 2022 9:27:53 AM AST (GMT +03:00)  
Status: N/A

DOCUMENT ATTACHMENTS (1)

File	Document No	Revision	Revision Date	Title	Status
	00102-AST-REQ-MR-00116	00	29/10/2022	Prequalification documents for Water Proofing System (Tanking , Wet Area , Roofing)	B - Approved with Comments

MESSAGE

Workflow Review History

The attached documents have completed the "(Astra) Transmission Line-Submittal for Approval (ARC)00102-AST-REQ-MR-00116 - Prequalification documents for Water Proofing System (Tanking , Wet Area , Roofing)" workflow with the following results :

*This transmittal was automatically generated.*

Doc No	Step	Participant	Review Outcome	Comments
00102-AST-REQ-MR-00116	Saudi Parsons	A Mohammed	B - Approved with Comments	1. The Prequalification for gulf crete is accepted as per attached documents to

<https://ksa1.aconex.com/Logon?Action=View&ENTITY=MAIL&ID=1356263876&USERID=1342279151>

1/2



MAIL TYPE: Workflow Transmittal  
MAIL NUMBER: ATK-WTRAN-007510  
REFERENCE NUMBER: ATK-WTRAN-007510

**Final (WF-161451) Pre-Qualification Documents of GULF CRETE for Thermal and Moisture Protection (Water Proofing)**

From: Ms Wejdan Almadi - WS ATKINS & Partners Overseas  
To (6): Mr DC Misk Art Institute - SaudCo (+5 more...)  
Cc (10): Christian Salas - Misk City Company (+9 more...)  
Sent: Monday, 10 July 2023 5:18:43 PM AST (GMT +03:00)  
Status: N/A

DOCUMENT ATTACHMENTS (1)

File	Document No	Revision	Revision Date	Title	Status
	P-0006-PHD1-P02-02A15-6CL-PQD-CIV-000008	00	02/07/2023	Pre Qualification Documents of GULF CRETE for Thermal and Moisture Protection (Water Proofing)	C - Revise and Resubmit

ATTRIBUTES

Attribute 1: Civil

MESSAGE

Workflow Review History

The attached documents have completed the "Pre-Qualification Documents of GULF CRETE for Thermal and Moisture Protection (Water Proofing)" workflow with the following results :

*This transmittal was automatically generated.*

Doc No	Step	Participant	Review Outcome	Comments
P-0006-PHD1-P02-02A15-6CL-PQD-CIV-000008	QA Check	M DC	QA Accepted	
	Step 1 - Review	G Kulkarni	B - Approved with Comments	PQD checklist shall be attached. Riyadh Chamber certificate Expired. ISO Certificate expired. HSE policy shall be signed by Authorised Signatory. Valid Applicator certificate shall be attached for the proposed material for the project. All the documents shall be renewed as required.
	QA/QC	N Panwar	B - Approved with Comments	





Client: DGCL Diriyah Gate Company Limited				شركة المصنعة للبتون SHAD CONSTRUCTORS			
PMC		CSC		CSC			
<b>COMMENTS RESOLUTION SHEET (CRS)</b>							
REVIEWED DOCUMENT DATA			Final Response Code				
CRS Revision:	0			<b>B-Approved with Comments - Work May Proceed (Subject to Compliance with the Comments) - Resubmission Required</b>			
Workflow Number:	WF-261157						
Subject / Document Title	Pre Qualification Documents of GULF CRETE for Thermal & Moisture Protection and Epoxy Coating	Document Type	PQ				
Document Number:	DG-PIN-471-0000-SCL-PQQ-PR-000073	Document Rev.	0				
Received Date:	17.04.2023	Response Date:	19.04.2023				
Approval Code Legends							
1	A	Approved or Approved as Noted - Work May Proceed - Resubmission Not Required	CSC Representative (Name & Sign):- Miyan				
2	B	Approved with Comments - Work May Proceed (Subject to Compliance with the Comments) - Resubmission Required	CSC Representative (Name & Sign):- Emel Mikhe				
3	C	Revise & Resubmit - Work May Not Proceed	(Optional) PMC / Parsons (Name & Sign):-				
4	D	Rejected / Review Not Required					
No.	Doc # / Section / Page #	Comments	Reviewed and Commented by	Organization	Status	Contractor's Response	Response By
<b>1<sup>st</sup> Cycle Comment</b>							
1	PQ	Arrangement of paper i.e. orientation are not proper. Kindly check prior submission.	Miyan	AECOM	Code B	noted and updated	Feras Elbadawy
2	PQ	Safeguarding of Wages certificate to be attached	Miyan	AECOM	Code B	noted and attached - Page 177	Feras Elbadawy
3	PQ	Draft Warranty certificate to be attached.	Miyan	AECOM	Code B	noted and attached - Pages 232-234	Feras Elbadawy
4	PQ	Zakat Certificate already expired.	Miyan	AECOM	Code B	noted and updated - Page 116	Feras Elbadawy
5	PQ	GOSI certificate already expired.	Miyan	AECOM	Code B	noted and updated - Page 116	Feras Elbadawy
6	PQ	Saudization Certificate already expired.	Miyan	AECOM	Code B	noted and updated - Page 115	Feras Elbadawy
7	PQ	Approval subjected to satisfactory performance and Mock-up at site in compliance with the project specification.	Miyan	AECOM	Code B	noted	Feras Elbadawy
8				Please Select	Please Select		
9				Please Select	Please Select		
10				Please Select	Please Select		
<b>Notes</b>							
1							
2							
3							

Client: 	Consultant: 	Contractor: 
<b>TECHNICAL DOCUMENTS</b>		
Project Name: HAIF – Six Flags		Project Code: QC02001
Location:		Date: 17-October-2022
Document Title: Prequalification Document for the Gulf-Crete Company		Ref No: QC02001-HAI-TEC-PQD-CIV-00-Z00-00001
		Rev No: 00
Department: <input type="checkbox"/> Architectural <input type="checkbox"/> Structural <input type="checkbox"/> Electrical <input type="checkbox"/> Mechanical <input type="checkbox"/> Authority <input checked="" type="checkbox"/> Others		
Type: <input type="checkbox"/> Pre-Qualification <input type="checkbox"/> Method Statement <input type="checkbox"/> Material Submittal <input type="checkbox"/> Sample <input checked="" type="checkbox"/> Other		
Document Description:		
Doc. Ref. No.	Title	
	Prequalification Document for the Gulf-Crete Company	
Enclosure:		
<b>Submitted By:</b> Name: Mohmd. Falah Signature: Date: 17-Oct-2022		<b>Received By:</b> Name: Signature: Date:
<b>Below portion for Consultant Supervision use only</b>		
Status: <input type="checkbox"/> A- Approved <input checked="" type="checkbox"/> B- Approved as noted <input type="checkbox"/> C- Revise & Resubmit <input type="checkbox"/> R- For information only		
Comments:		
Refer to attached Atkins comment sheet.		
<b>Below portion for Client use only</b>		
Comments:		
Signed by: _____ Signature: _____ Date: _____		





	Document Title:	DOCUMENT SUBMISSION FORM (DSF)			
	Project Name:	INFRASTRUCTURE AND NETWORKS-84 RBF IN DAMMAM-2	Project Contractor:		Gulf Builder
	Project Number:	DAM2-01-010	Project Consultant:		Worley
Document Reference No:		DAM2-02-010-GB-TS9-3-DSF-CVL-000014-00			
<b>CIVIL &amp; STRUCTURAL</b>					
DOCUMENT ISSUED BY		DOCUMENT RECEIVED BY			
Issued By	Engr Ahmed Abdel Fatah	Received By	SULIMAN NOJYFAN		
Position/Company	Project Manager	Position/Company	D.C.		
Signature		Signature			
Date	11-02-2020	Date	11 FEB 17 02/2020		
<b>ATTACHMENTS</b>					
source		Manufacturer		Bill of Quantities	
Certification		Manual		Method Statement	
<input checked="" type="checkbox"/> Sub-contractor		<input checked="" type="checkbox"/> Pre-qualification		Technical Information	
Engineering Calculation		Procedure/ Methodology		Bank Warranty	
Job Order		Product Data		Letter	
Sample		Test Report		Shop drawings	
<b>PURPOSE FOR DOCUMENT SUBMISSION</b>					
FOR INFORMATION	<input type="checkbox"/>	FOR REVIEW & APPROVAL	<input checked="" type="checkbox"/>	AS REQUESTED	
				OTHER(As Noted) <input type="checkbox"/>	
<b>SUBMITTED DOCUMENTS REFERENCE NUMBERS</b>					
#	Document Reference No.	Document Description	Rev.	Hard Copy	Soft Copy
1	GULF CRETE LTD.	Contractor for Water proofing and Insulation Work	00		<input checked="" type="checkbox"/>
2					
<b>RESPONSE STATUS</b>					
APPROVED AS SUBMITTED (APP)	<input checked="" type="checkbox"/>	APPROVED AS NOTED (APN)	<input type="checkbox"/>	REJECTED/RE-SUBMIT (RRS)	<input type="checkbox"/>
<b>COMMENTS</b>					
<p>* The Subcontractor is approved for the water proofing and insulation works only.</p> <p>13/02/2020</p>					
RESPONSE ISSUED BY		RESPONSE RECEIVED BY			
Issued By	Bassam Saad	Received By			
Position/Company	CM	Position/Company			
Signature		Signature			
Date	13/02/2020	Date			
<p>Note: Approval by the consultant shall not release the contractor of its obligations and liabilities under the contract in case of any discrepancy between the inspected works and final approved designs, the contractor shall carry out the necessary remedies, rectifications, demolishing and reconstruction according to the final approved design without the right to claim extra cost and time</p>					

Client:		Consultant:		Contractor:	
<b>TECHNICAL DOCUMENTS</b>					
Project Name: Resort Core Bulk Grading & Tunnel Construction Works			Project Code: QC00912006		
Location: Z00			Date: 08-Apr-2023		
Document Title: Pre-Qualification Document of Gulf Crete Ltd. Company for Supply & Installation of PVC Waterproofing Systems (Rev.01).			Ref: QC00912006-SAJ-TEC-PQD-STR-00-Z00-00007		
			Rev No: 01		
Department: <input type="checkbox"/> Civil <input checked="" type="checkbox"/> Structural <input type="checkbox"/> Electrical <input type="checkbox"/> Mechanical <input type="checkbox"/> Authority <input type="checkbox"/> Others					
Type: <input checked="" type="checkbox"/> Pre-Qualification <input type="checkbox"/> Method Statement <input type="checkbox"/> Material Submittal <input type="checkbox"/> ITP <input type="checkbox"/> Other					
<b>Document Description:</b>					
<ol style="list-style-type: none"> <li>This document contains the Contractor response on Revision 00 comments along with some additional required documents. i.e. CVs, manpower &amp; equipment resources and experience/approval letters.</li> <li>Material Manufacturers Prequalification's and Material Technical Submittal will be submitted separately.</li> </ol>					
Doc. Ref. No.		Title			
Enclosure:					
<b>Submitted By:</b>			<b>Received By:</b>		
Name: Project Manager: Engr. Sami Abuhajleh			Name:		
Signature:			Signature:		
Date: 08-Apr-2023			Date:		
<b>Below portion for Consultant Supervision use only</b>					
Status: <input type="checkbox"/> A- Approved <input type="checkbox"/> B- Approved as noted <input type="checkbox"/> C- Revise & Resubmit <input type="checkbox"/> R- For information only					
<b>Comments:</b>					
<ol style="list-style-type: none"> <li>Legal address - No office address provided - Refer to comment no.1</li> <li>QC procedure is still generic. Not specific to water proofing- refer to comment no.3</li> <li>Previous approvals provided not satisfactory for water proofing for our project. refer to comments no.11</li> </ol>					
			B - Approved with Comments		
			Mr Divakaran Ajith - Jacobs Engineering Group Inc.		
			Apr 19, 2023, 3:43 PM GMT+3:00		
<b>Below portion for Client use only</b>					
<b>Comments:</b>					
Signed by:		Signature:		Date:	





Doc No: DG-DSQ-316-0000-SSA-PQQ-PR-000188  
 Revision: 00  
 Date: 18 August 2022  
 Page: 1 of 2



## (DRF) Document Review Form (Submittal)

### Part 1 – Issue / Receive / Distribute

Employer: Diriyah Gate Development Authority  
 Contractor: Salini Saudi Arabia  
 Project: DSQ Package 2 – Super Basement  
 Contract/ Work Package: DD-2020-249 / DSQ 316  
 Construction Supervisor: AECOM Arabia

Document Type	Document Reference
PREQUALIFICATION	DG-DSQ-316-0000-SSA-PQQ-PR-000188(00)

Document Description	
Title	PREQUALIFICATION- Subcontractor for Epoxy Coating Applicator (Subcon: Gulf Crete Ltd)
Package:	DSQ Package 2
Discipline:	Procurement
Work Location:	Package 2 super basement

List of Attachments (If Any)

Issued By: Contractor  
 Name: Marco Tentorio Date: 18 August 2022  
 Role: Contractor's Representative  
 Signature & Stamp: 

Doc No: DG-DSQ-316-0000-SSA-PQQ-PR-000188  
 Revision: 00  
 Date: 18 August 2022  
 Page: 2 of 2



### Part 2 – Review and Response

Review Comments (to be completed by the Construction Supervisor/ Consultant)

**Approved**

Reviewed By: Consultant / Construction Supervisor  
 Name: \_\_\_\_\_ Date: \_\_\_\_\_  
 Signature: \_\_\_\_\_

### Part 3 – Approval

A. Approved  B. Approved with Comments  C. Revise and Resubmit  D. Rejected

Approved By: Consultant / Construction Supervisor  
 Name: Bernard Grace  
 Role: Resident Engineer  
 Signature:  31/08/2022







CERTIFICATION

Consultant:		Client:		Contractor:	
PROJECT NO: KSUEH-AR-010		LOCATION: RYADH-KSA			
PROJECT NAME: KSUEH- BUILDING 04					
MATERIALS SUBMITTAL					
<input checked="" type="checkbox"/> NEW SUBMITTAL		SUBMITTAL NO: KSUEH-AR-010		PREV. SUBMITTAL NO:	
<input type="checkbox"/> SUBMITTAL		DATE: 19 Feb-17		PREV. SUB AL DATE:	
Submittal reason: <input type="checkbox"/> INFO <input type="checkbox"/> NOTES <input checked="" type="checkbox"/> APPROVAL					
Major: <input type="checkbox"/> CV <input checked="" type="checkbox"/> AR <input type="checkbox"/> ST <input type="checkbox"/> AC <input type="checkbox"/> EL <input type="checkbox"/> PL <input type="checkbox"/> OTHER					
Attachments: <input checked="" type="checkbox"/> Brochure <input checked="" type="checkbox"/> Tech. Info <input type="checkbox"/> Sample <input checked="" type="checkbox"/> Certificate <input type="checkbox"/> Drawing <input type="checkbox"/> Calculations					
Materials/Tools					
Serial	Material Name, Number & Description	Source	Supplier / Manufacturer	Specs. Ref	Code Status
1	Concrete Repairs	Local	Gulf Crete LTD.		B
2	Protective Coating (Epoxy)				
3	Fire Proofing				
4	Water Proofing				
CONTRACTOR:		Project Manager:			
Procurement Manager Name:		Name: Ayman Shaban Site Engr. Muhamed Zyadeh			
Signature:		Signature:			
CONSULTANT NOTES:					
<i>*Accepted as a subcontractor and to be provide complete information and materials details and data sheet for review and approval.</i>					
<i>*Provide warranty Certificate as per project specs and Contract.</i>					
CONSULTANT:			STRATEGIC CONSTRUCTION PROGRAM		
Name: Avazag Najjar			Date:		
Position: Arch			Signature:		
Signature:			ENG. KHALID FAHD AL-SHAIDDI		
Date: 2/2/2017			General Manager of Strategic Construction Program		
APPROVAL SITUATION					
<input checked="" type="checkbox"/> APPROVED		<input type="checkbox"/> REJECTED		<input type="checkbox"/> NO ACTION	
<input type="checkbox"/> APP. WITH COMMENTS		<input type="checkbox"/> NO ACTION		<input type="checkbox"/> NO ACTION	
<input type="checkbox"/> APP. AS NOTED / RESUBMITTAL REQUIRED		<input type="checkbox"/> NO ACTION		<input type="checkbox"/> NO ACTION	
INCOMING SIGNATURE:		OUTGOING SIGNATURE:		DATE:	
DATE:		DATE:		DATE:	
Consultant: Original		Contractor: Copy with Stamp		Consultant Site Office: Copy	
(Authority to proceed with work does not relieve the contractor from contractual responsibilities)					



CERTIFICATION

HEMPEL PAINTS (SAUDI ARABIA) W.L.L. Tel: +966 11 407 7039  
 P.O. Box 3977, Riyadh 11481 Fax: +966 11 407 8012  
 Kingdom of Saudi Arabia Share Capital SR 24,500,000  
 CR 1010018138 Website: hempel.com

شركة اصباغ هيمبل العربية السعودية م.م  
 ص.ب. 3977 - الرياض 11481  
 رأس المال: 24,500,000 ريال سعودي  
 السجل التجاري: 1010018138  
 الموقع الإلكتروني: hempel.com

Date: 14 NOVEMBER 2017

CERTIFICATION

HEMPEL PAINTS (SAUDI ARABIA) W.L.L. recommends **GULF CRETE LTD.** as an approved Hempel Paints Applicator for the application of its products for both Decorative and Epoxy painting.

Through regular supervision and inspections from the period of two years Hempel Paints has found **GULF CRETE LTD.** be both professional and competent in application of Hempel Paints. They have proven their capability in successfully completing a large number of projects including commercial complexes and single villa projects.

This recommendation is valid for 12 months and will be subject to review on **13 NOVEMBER 2018.**

Furthermore, this recommendation is made by Hempel Paints without prejudice and/or legal liability of whatsoever kind of Hempel Paints.

Yours faithfully,  
 For HEMPEL PAINTS (SAUDI ARABIA W.L.L.)

Ibrahim El Shalkamy  
 Branch Manager  
 Central Region



## APPROVED APPLICATOR CERTIFICATE

### GULF CRETE CO.

This is to advise that, **M/S GULF CRETE CO.** has been registered as an approved applicator and the company demonstrated competence in applying the following Master Builders Solutions Saudi Arabia product/s range below:

- » Epoxy & PU Flooring Systems
- » Waterproofing system
- » Concrete Repair

This certificate has been issued upon the request of **GULF CRETE CO.** without having any liability on Master Builders Solutions Saudi Arabia. It is the sole responsibility of **GULF CRETE CO.** to strictly follow the written Method Statement, use proper tools/equipment and maintain good workmanship while applying the products.

This certificate is valid for **6 months** from this date and Master Builders Solutions Saudi Arabia reserve the right to cancel / withdraw the certificate any time if the application of the products is not in line with our written Method Statement. In the occurrence of the above, this certificate become null and void.

For and on behalf of  
Master Builders Solutions Saudi Arabia for Manufacturing LLC



Prasad Anandu Warkar  
Quality Manager

Date : 19<sup>th</sup> June 2022  
Ref. No. : AA/PW/030/2022



Comments / Replies Legends & Status		Comment Code Legend (for individual comments):		Reply Code Legend:		Open / Closed			
		1 = Action Required; 2 = Note / Advisory / Recommendation		i = Incorporated; ii = Not incorporated for reason stated in reply					
No.	Initial	Page / Section / Sheet	Comment Code	Reviewer Comment	Reply Code	Originator Reply	Reply Status by Reviewer		
1	RB		2	Years of Experience: 20 Years (Operating experience locally)					
2	RB		2	Gulf Crete Ltd. Is previously approved within KAFD Projects (P1.11 & P2.11) - Per Attached Document Approval & Certificate					
3	RB		1	GOSI Certificatein (Attached) is Expired. Key Management and Technical Resources CV are not attach.					
4	RB		2	List of Previous Projects with documented evidences such as List of Partnerships & Valued Costumers, Major projects & References, Customers Approval & Certificates, Project Compliance Certificates, Company Organizational Chart, QHSE Plan & QC Plan are attach.					
5	RB		2	JASARA PQD form is attached. Ministry of Commerce & investment, Chamber of commerce, ISO Certificates, Company Registration, ZAKAT & TAX Certificate, VAT Registration Certificate, Saudization are attached & valid.					
6	RB		2	Final acceptance is subject to JLL approval.					
7	RB		2	Comments are made on the documents as presented. The content remains the responsibility of the author in all respects					
Review Status Code:		B		A-Approved D - No Objection		B - Approved with Comments E - No Objection with Comments		C - Objection	
Reviewer Name(s) / Initials		Supervision Consultant (SC)		Project Management-Construction Management (PMCM)		Programme Management Office (PMO)		Originator	
Position		COMMENTS / STATUS RECOMMENDED BY SC		COMMENTS / STATUS RECOMMENDED BY PMCM		COMMENTS / STATUS ADVISED BY PMO		REPLY APPROVED BY	
Roger Burnot (RB)		Name: Paul Atkinson		Name: <i>Paul Atkinson</i>		Name:		Name:	
<i>Joseph</i>		Position: Project Director		Position: <i>PM</i>		Position:		Position:	
		Signature: <i>PA</i>		Signature: <i>Paul Atkinson</i>		Signature:		Signature:	
		Date: <i>6/19/20</i>		Date: <i>02-09-2020</i>		Date:		Date:	

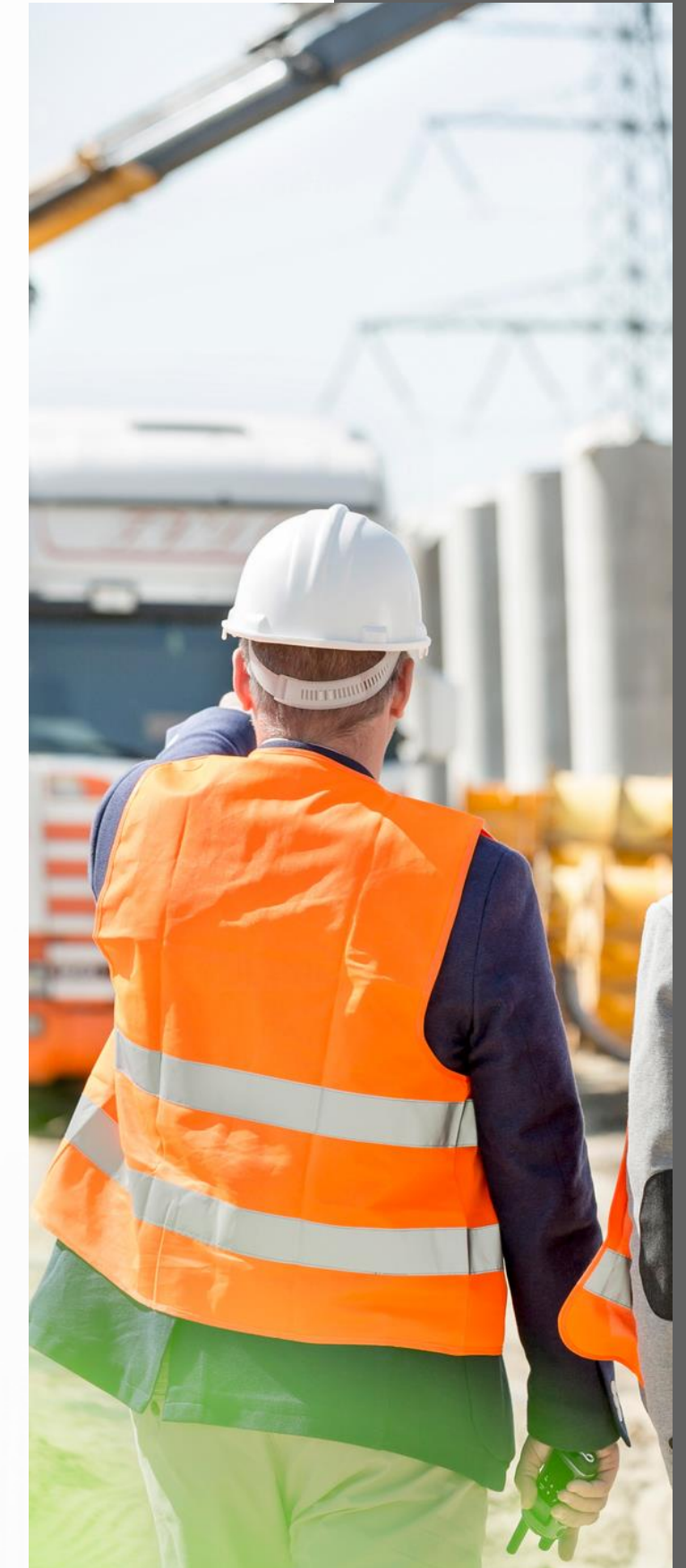

**KAFD**  
Transmittal Form

To: Paul Atkinson (Project Director)	Date: 02/09/2020
Company Name: Dar Al Riyadh	Transmittal no.: KAFD-RY-RIA1-PGEN-SAB-DCM-TRN-06578
Address: KAFD Area Parcel 5.05 7 <sup>th</sup> Floor, Riyadh, KSA	Project No: CJ01(Parcels 4.05, 5.03, 5.04, 5.05 & 5.06)

**Documents transmitted**

<input type="checkbox"/> Drawings	<input type="checkbox"/> Contracts	<input type="checkbox"/> Specifications
<input type="checkbox"/> Samples	<input type="checkbox"/> Plans	<input type="checkbox"/> Change Order
<input type="checkbox"/> Procedures	<input checked="" type="checkbox"/> Others(PRE-QUALIFICATION)	

<b>Transmitted for:</b>			<b>Review:</b>		
<input checked="" type="checkbox"/> Approval	<input type="checkbox"/> Information only	<input type="checkbox"/> Tender	<input type="checkbox"/> A - Approved		
<input type="checkbox"/> Action	<input type="checkbox"/> Design	<input type="checkbox"/> Estimating	<input checked="" type="checkbox"/> B - Approved as noted		
<input type="checkbox"/> Review & Comment	<input type="checkbox"/> Construction	<input type="checkbox"/> Quotation	<input type="checkbox"/> C - Revised and Resubmit		
<input type="checkbox"/> Use	<input type="checkbox"/> Handover	<input type="checkbox"/> Purchase	<input type="checkbox"/> D - Rejected		
<input type="checkbox"/> Submittal	<input type="checkbox"/> Other:		<input type="checkbox"/> E - Review not Required		

**Transmitted via:**

Hard Copy     Soft Copy     Hard & Soft Copy

S.N	Doc Ref.	Rev.	Description	No. of Copies
1	KAFD-RY-RIA1-PGEN-SAB-COM-PQD-00052	00	PRE-QUALIFICATION FOR EPOXY APPLICATOR (GULF CRETE LTD)	



Sender's Name: Halil Ekinci    Job title: Project Manager    Signature:    Date: 02/09/2020

**Acknowledgement of receipt** (kindly acknowledge receipt and return this sheet to the sender)

Recipient's Name:    Job title:    Signature:    Date: Select date.

Remarks: Refer to attached engineer comments in OCS.

**PROJECTS DEPARTMENT- CENTRAL**  
**CIVIL & ELECTROMECHANICAL PROJECTS DIVISION**  
Address: SEC Head Quaters, Tower : C-2F,Al-Arid

**REVIEW OF CONTRACTOR'S SUBMITTAL**

Use: C-for Civil, E- for Electrical, M- for Mechanical, and SF- for Safety

Submittal No.:	C 8358/C & EMPD/MAE/21-107.REV01	Date:	02/09/2021G
----------------	----------------------------------	-------	-------------

**PROJECT TITLE :** Construction of 132/13.8KV S/S 8358 For Misk City Project With 132KV Network In Riyadh Area

**PTS NO. :** 20CN190    **BI NO. :**    **JO NO.:**

<b>To :</b> C & EMPD : Division Manager SEC HEAD QUATERS TOWER C-2F, AL-ARID, RIYADH Telephone Number: (011) 80 - 77860	<b>From :</b> (Contractor) Contractor's Name: AL-BABTAIN CONTRACTING CO. Contractor's Address: Al-Ihsa St., Riyadh SA Tel. number: (011) 47-77715 Ext : 1402
--	---

ACCEPTANCE OF THE FOLLOWING SUBMITTAL IS HEREBY REQUESTED

Check Appropriate Box:  Drawings / Sketches     Materials / Equipment     Test Reports/ Calculations     Others

**FILL-UP APPLICABLE INFORMATION BELOW:**

**Description :** S/S 8358 - METHOD OF STATEMENT FOR SOIL CAVITY INJECTION REV01 - REPLY TO SEC COMMENTS

**Reference Specification :** SEC LTER # 21/8358-46/12031301 DATED 31/08/2021G

**Manufacturer/Supplier :**

COMPLYING WITH SCOPE OF WORK AND TECHNICAL SPECIFICATIONS?  YES     NO  
IF "NO" INDICATE DEVIATIONS : (Provide justification and attach supporting documents)

<b>Submitted by :</b> Project Manager (Contractor) Signature: Name: MOHAMED ABU EL-EINEIN Date: 02/09/2021G	<b>Received by:</b> Civil Engineer, C & EMPD Signature: Name: Eng'r Harish Antaram Pawar Date:
---	---

**FOR OFFICIAL USE ONLY**

SEC-COA/Projects Department has reviewed the above submittal and found it:	<b>REMARKS :</b> Refer attacheemnt for comments
<input type="checkbox"/> ACCEPTABLE <input checked="" type="checkbox"/> ACCEPTABLE, AS NOTED <input type="checkbox"/> NOT ACCEPTABLE (RESUBMIT) <input type="checkbox"/> PROVIDE ADDITIONAL INFORMATION <input checked="" type="checkbox"/> SEE ATTACHED COMMENTS	
<b>Group Leader, C &amp; EMPD</b> Signature: Name: Eng'r Mohammed Alkhalidi SEC Ref.: 21/8358-50/12031301 Dt:08/09/2021	<b>Please use extra sheets if needed.</b> Received by Signature: (Contractor) Name:

**NOTE :** Acceptance does not release the Contractor from his responsibilities in performing the work in strict conformance with Contract, Scope of Work and Technical Specifications.

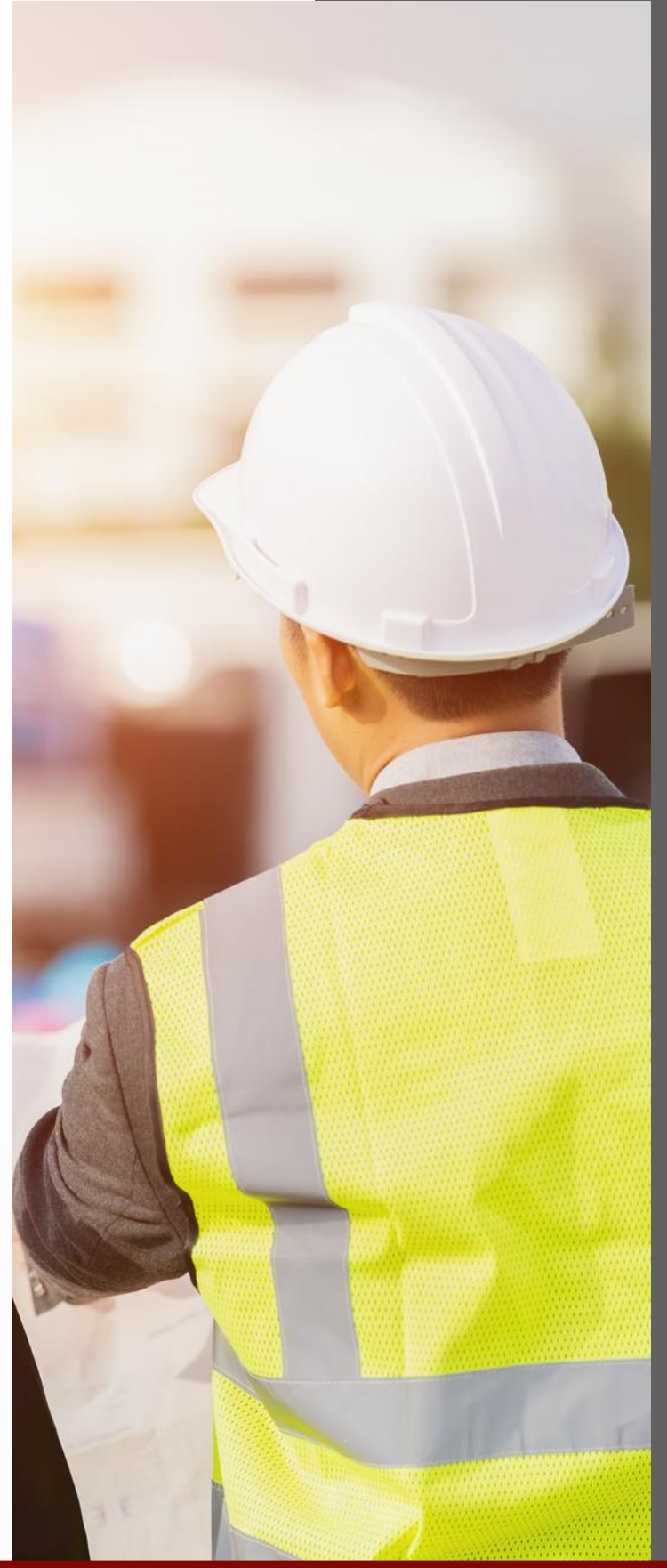



**TRANSMITTAL DETAILS**  
 Program: Y Construction Supervision  
 Project: KAFD-A1-C01-GEN-CS-TRN-00814  
 Transmittal ID: PQD-Prequalification No.0044-R1  
 Subject: and 0052-R0 PGEN for Approval  
 Purpose: For Approval  
 Issue date: 08/09/2020  
 Response due date: 9/20/2020

**SENDER**  
 Issued by: Ahmad, Ahlaq  
 Email: aahlaq.ahmad@daralriyadh.com  
 Phone (1):  
 Phone (2):

Recipient name	Response required	Company	Recipient title	Email
Mohamed Farooq	NO	DAR-AL Riyadh	QA QC Engineer	Mohamed.Farooq@daralriyadh.com
Paul Atkinson	NO	DAR-AL Riyadh	Project Manager	Paul.Atkinson@daralriyadh.com
Abda Ikader Al-Bekour	YES	JLL	Project Manager	Abdalikader.Bekour@eu.jll.com
Ahmed Batool	YES	JLL	Project Manager	Ahmed.Batool@eu.jll.com
Brad Adams	NO	JLL	Construction Director	Brad.Adams@eu.jll.com
David Connolly	NO	JLL	Technical Director	David.Connolly@eu.jll.com
Desai Binju	NO	JLL	Sr. Planner	Binju.Desai@eu.jll.com
Fazal Reman	NO	JLL	Document Controller	Fazal.Reman@eu.jll.com
Greg Potts	NO	JLL		Greg.Potts@eu.jll.com
Ian Armstrong	YES	JLL	Project Director	Ian.Armstrong@eu.jll.com
JLL KAFD Document Control	NO	JLL	Document Control	JLLMENA-KAFD-DocumentControls@eu.jll.com
Mervyn Nicholl	YES	JLL	Delivery Team	Mervyn.Nicholl@eu.jll.com
Ricardo Fachin	YES	JLL	Sr. Project Manager	Ricardo.Fachin@eu.jll.com
Wilus VanZyl	YES	JLL	Associate Director	Wilus.VanZyl@eu.jll.com
Ziad Sinno	YES	JLL	Project Manager	Ziad.Sinno@eu.jll.com

**NOTES**  
 All.  
 Please find the attached PQD's No.0044-R1 and 0052-R0 for your information and approval as well.  
 Regards,  
 Ahlaq Ahmad

**ATTACHMENT**

Item no.	File name	Version	State	Description	Review Code
1	KAFD-RY-RIA1-PGEN-SAB-COM-PQD-0044-R1.pdf	R01	Published	PQD for Alkar Mamarayah Est to Cover Steel and Grating Works	
2	KAFD-RY-RIA1-PGEN-SAB-COM-PQD-0052.pdf	R00	Published	PQD for Epoxy Applicator (Gulf Crete Ltd)	B

**REFERENCES**

Item no.	File name	Version	State	Reference of
1				

**GENERAL INFORMATION**

Discipline		Document Type	Hard Copy Received	
PMT	MEP	LTR	Hard Copy	
PCM	ELE	DWG	Soft Copy (CD/DVD)	
DCM	CON	Tech.Doc		
BSK	QMS	MOM		
COM	HSE	RPT		
ENG	SHM	WPR		
ARC	ADM	MPR		
Civil	HRM	Other		

**FOR RECIPIENT/REVIEWER USE ONLY**

Review Status	Approved-A	No Objection-D	Incomplete Document to Review
Approved with Comment-B	<input checked="" type="checkbox"/>	No Objection with Comment-E	Accepted for Construction
Objection-C		No Review Required	Accepted As-Built

Reviewer Comment  
 Refer to OCS sheet

Reviewed By: Ziad Sinno, PM  
 Approved By: [Signature]

## APPROVED APPLICATOR CERTIFICATE

GULF CRETE CO.

This is to advise that, M/S GULF CRETE CO. has been registered as an approved applicator and the company demonstrated competence in applying the following Master Builders Solutions Saudi Arabia product/s range below:

- » Epoxy & PU Flooring Systems
- » Waterproofing system
- » Concrete Repair

This certificate has been issued upon the request of GULF CRETE CO. without having any liability on Master Builders Solutions Saudi Arabia. It is the sole responsibility of GULF CRETE CO. to strictly follow the written Method Statement, use proper tools/equipment and maintain good workmanship while applying the products.

This certificate is valid for **6 months** from this date and Master Builders Solutions Saudi Arabia reserve the right to cancel / withdraw the certificate any time if the application of the products is not in line with our written Method Statement. In the occurrence of the above, this certificate become null and void.

For and on behalf of  
 Master Builders Solutions Saudi Arabia for Manufacturing LLC

Date : 2nd April 2023  
 Ref. No. : AA/PW/075/2023

Prasad Anandu Warkar  
 Quality Manager

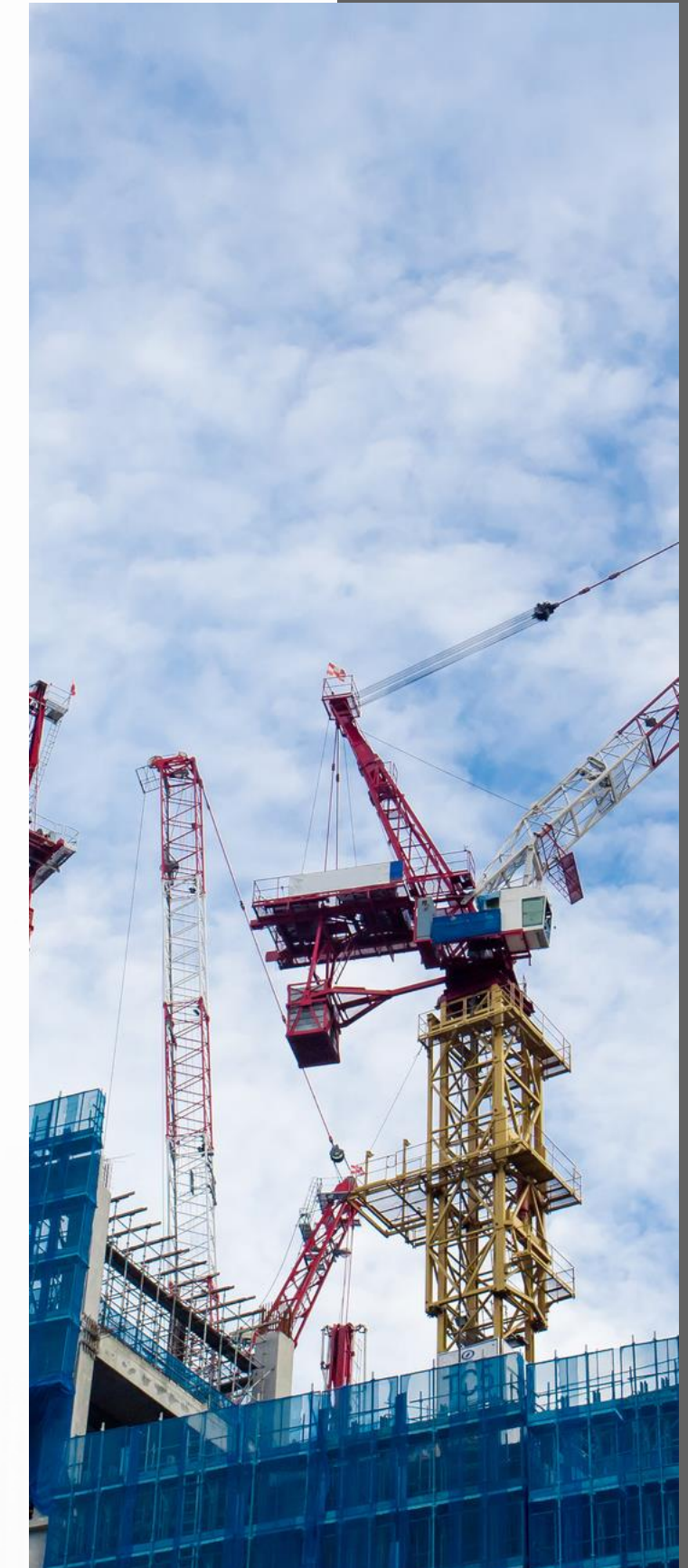

KINGDOM OF SAUDI ARABIA  
Council of Cooperative Health Insurance  
Secretariat General

المملكة العربية السعودية  
مجلس التعاون الصحي التعاوني  
الإدارة العامة

شهادة إنجاز

بهذا يشهد مجلس الضمان الصحي التعاوني، بأن شركة خليج  
الخرسانة، قد قامت بتنفيذ مشروع "إعادة تخطيط، تركيب مصدات  
ولوحات إرشادية، طلاء أبوكسي لجميع مواقف السيارات الداخلية  
والخارجية لمبنى الأمانة العامة".  
كما يشهد المجلس، بأن شركة خليج الخرسانة، قد أوفت بكافة التزاماتها  
الخاصة بهذا المشروع بكفاءة ووفقاً للجدول الزمني المحدد لها وبصفة  
مرضية.  
وقد أعطيت هذه الشهادة لشركة خليج الخرسانة كشهادة إنجاز لأعمال  
المشروع بنجاح.

الأمين العام  
محمد بن سليمان الحسين

الأمانة العامة

Adwaa Al-Tamayuz For  
Contracting Co. Ltd.  
C. No. 101022 (228)

شركة إصواء التميز للمقاولات  
مكة مسؤولة معتمدة  
سجل تجاري ١٠٠٢٢٢٢٩  
رأس المال ١٠٠٠٠٠٠ ريال سعودي مدفوع بالكامل

TO WHOM IT MAY CONCERN

This is to certify that M/S. GULF CRETE Ltd Company has done the epoxy coating for Riyadh warehouse as per required Specification and in good quality.  
This certification has been given to them as per there request





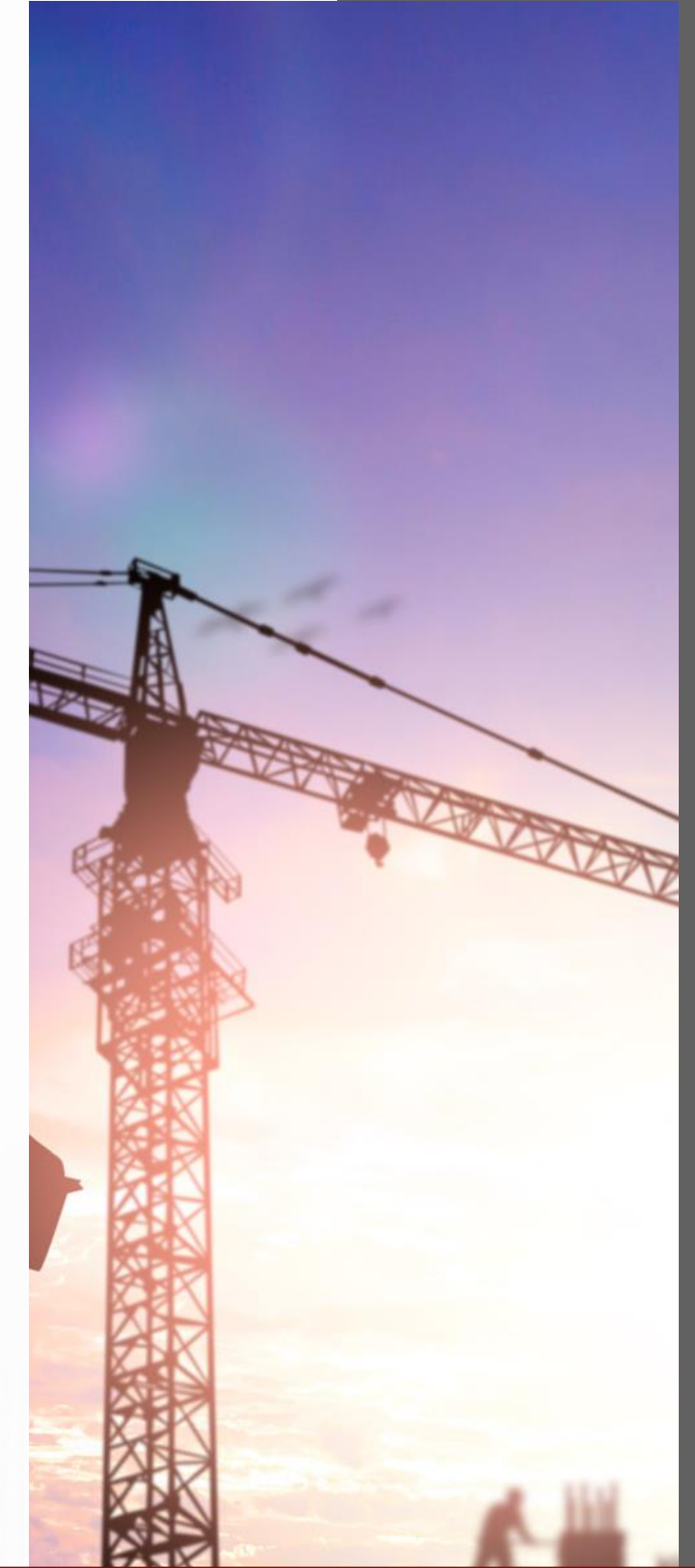

Parcel manager.  
Engr. Misbah S. al zabibi



ص.ب. الرياض ١١٤١٥ - المملكة العربية السعودية - هاتف : ٤١٩٤٠٤٣ - فاكس : ٤١٩٢٩٩٨ - رقم العضوية ١٦٧١٦٠  
P. O. Box 19671 Riyadh 11445 - Kingdom of Saudi Arabia - Tel.: 4194043 - Fax : 4192998 - C. C. No.167160  
www.adwaaaltamayuz.com - E-mail : info@adwaaaltamayuz.com







							
Client : National Housing Company		PMC : Dar al-handasah		Consultant : Khatib & Alami		General Contractor : Tamimi Global Company Ltd.	
<b>MATERIAL SUBMITTAL</b>							
AR	ME	CV	LA	Submittal No.	M	S	-
ST	FE	QS	OT	Date : 7/13/2020	2	2	1
To: Khatib & Alami				From: Tamimi Global Company Ltd.			
List of Enclosures							
Application for: Roof Insulation / waterproofing (Precast, Fursa, Buildings).							
Specification Ref. as per project specification (Sec.075700).				<input type="checkbox"/> Copy of Related Drawing			
BOQ Reference(s): MURCIA BOQ				<input type="checkbox"/> Compliance Statement			
Drawing Ref.:				<input type="checkbox"/> Catalogue			
Specified Material: PU.Foam, Acrylic / Cementitious Coating.				<input checked="" type="checkbox"/> Others (Specify)			
Proposed Material: PU.Foam, Acrylic / Cementitious Coating.				<input type="checkbox"/> Test Certificate			
Manufacturer / Local Supplier: GULF-CRETE LTD THE SPECIALIZED.CO				<input checked="" type="checkbox"/>			
Reasons for Alternative (if any): شركة التميمي				<input type="checkbox"/>			
Contractor's Remarks: TAMIMI GLOBAL CO. LTD. 2050004970							
Contractor Incoming Signature: [Signature]				Contractor Outgoing Signature: [Signature]			
Date: 16 JUL 2020				Date: 16 JUL 2020			
Consultant Comments:							
<p>• THE FOLLOWING MATERIAL HAVE BEEN APPROVED: POLYFOAM 10, POLYESTER S, ALYAF.</p> <p>• CALCULATION OF U-VALUE ARE WITHIN SBC 602, AS PROVIDED BY CONTRACTOR.</p> <p>• MOCKUP SAMPLE WITH TEST TO BE DONE PRIOR ANY DELIVERY.</p> <p>• COMPLETE SECTIONS AND DETAILS TO BE SUBMITTED ASAP.</p> <p>• SUBJECT TO NEGATIVE VARIATION ORDER INCL TO REMOVAL OF SBS WATERPROOF MEMBRANE. NEGATIVE ORDER TO BE FINALIZED PRIOR ANY INVOICING.</p>							
For K&A Signature: [Signature]				Date: 16/7/20			
<b>ACTION CODE:</b> <input type="checkbox"/> A = Approved <input checked="" type="checkbox"/> B = Approved as noted <input type="checkbox"/> C = Resubmit as Noted <input type="checkbox"/> D = Disapproved <input type="checkbox"/> E = No action taken <input type="checkbox"/> F = Retained for Info.							

							
Client : National Housing Company		PMC : Dar al-handasah		Consultant : Khatib & Alami		General Contractor : Tamimi Global Company Ltd.	
<b>SUPPLIER PRE-QUALIFICATION</b>							
AR	ME	CV	LA	Submittal No.	S	P	-
ST	EE	QS	OT	Date : 7/13/2020	1	2	4
To: Khatib & Alami				From: Tamimi Global Company Ltd.			
<b>Supplier Description</b>				<b>Attachments</b>			
Name: GULF CRETE LTD THE SPECIALIZED CO.				<input checked="" type="checkbox"/> Company Profile			
Telephone No.: 0114655034				<input checked="" type="checkbox"/> Valid Commercial Registration Certificate			
Address: RIYADH-KSA				<input checked="" type="checkbox"/> Valid Membership of Chamber of Commerce			
Person in Charge and His Mobile No: 599281826				<input checked="" type="checkbox"/> Valid VAT Registration Certificate			
Supplier's Qualifying Log:				<input checked="" type="checkbox"/> Valid Zakat & Tax Certificate			
Years of Experience (In Total): 20 YEARS				<input checked="" type="checkbox"/> Valid General Organization of Social Insurance			
Years of Experience In Saudi Arabia: 20 YEARS				<input checked="" type="checkbox"/> Valid Saudization Certificate			
				<input type="checkbox"/> Valid Contractor Classification Certificate			
				<input type="checkbox"/> Valid SASO Certificate			
				<input checked="" type="checkbox"/> Authorized Signatory of Responsible Person			
<b>Material to Supply: WATERPROOFING, INSULATION, FIREPROOFING, CONCRETE REPAIRS, AND FLOOR COATINGS</b>							
Approval of Supplier does not relieve contractor of his responsibilities under contract's terms.							
Contractor's Remarks: Hardcopy of company profil (3) , cd -softcopy (3)							
Contractor Incoming Signature: [Signature]				Contractor Outgoing Signature: [Signature]			
Date: 16 JUL 2020				Date: 16 JUL 2020			
Consultant Comments:							
<p>• SUPPLIER APPROVED TO PROVIDE THE ABOVE MENTIONED MATERIAL.</p> <p>• MATERIAL TO BE PROVIDED AND AREA OF APPLICATION IS SUBJECT TO CONSULTANT APPROVAL.</p> <p>• ANY MISSING CERTIFICATE, OR OUTDATED CERTIFICATE TO BE PROVIDED.</p>							
For K&A Signature: [Signature]				Date: 14/7/20			
<b>ACTION CODE:</b> <input type="checkbox"/> A = Approved <input checked="" type="checkbox"/> B = Approved as noted <input type="checkbox"/> C = Resubmit as Noted <input type="checkbox"/> D = Disapproved							
NOTE: The Client - National Housing Company (NHC) has the authority to approve/disapprove the supplier without any objection from all sides.							

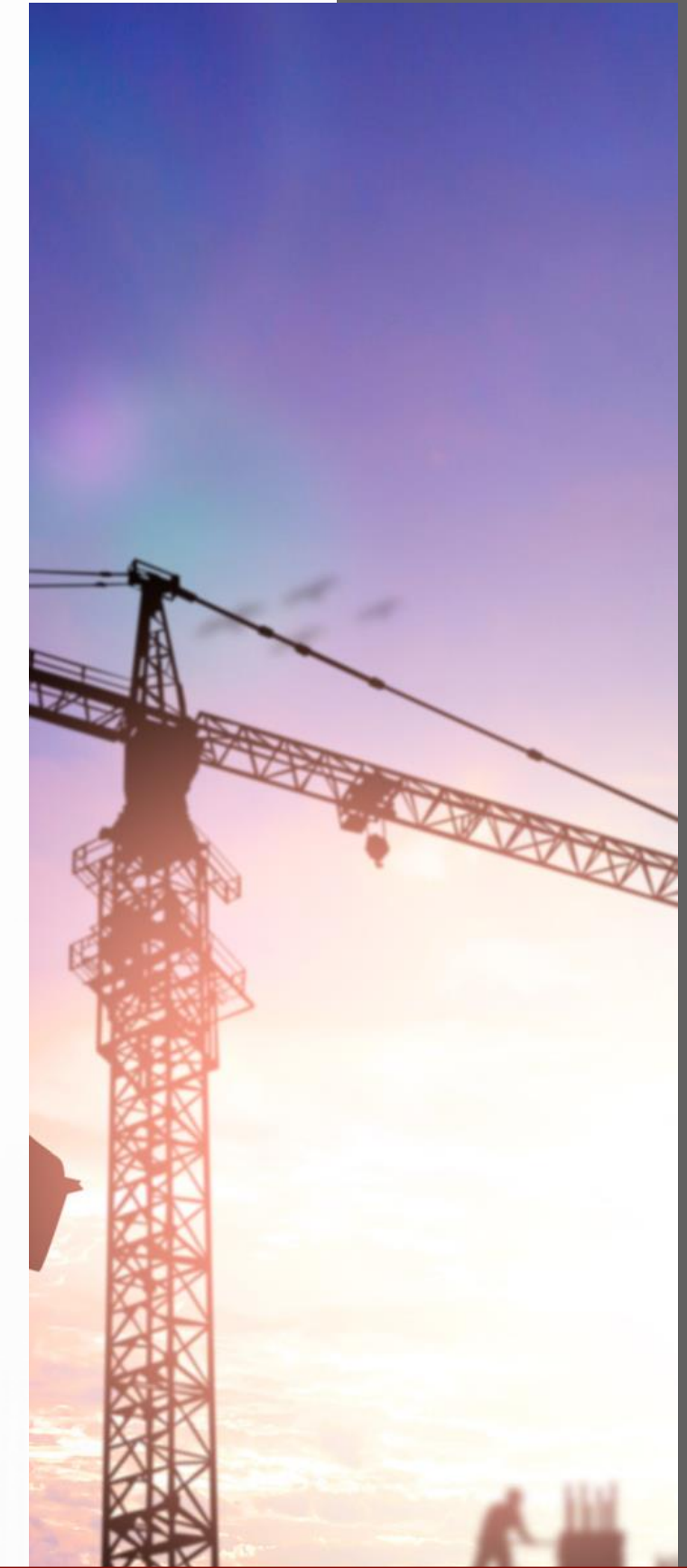

Date and Time Information

Date & Time of Print: 09/08/2021 14:08:21 - Time Zone: Arabia Time

Organisation Details

Organisation Name (English input will be accepted only)	Gulf Crete Ltd
Trade Market Name (English input will be accepted only)	Construction, Maintenance
Address	Riyadh
Country	SAUDI ARABIA
Region	Riyadh / منطقة الرياض
ZIP/Postal Code	11323
Main Organisation Phone Number	0114655034
Organisation Fax Number	0112939553
Organisation Email Address	gulfcrite@outlook.com
Web site	www.gulfcrite.com

Organisation Legal Structure

Private Limited or Limited Liability Company (شركة ذات مسؤولية محدودة)

Company Registration Number	1010419075
VAT Number	301099174300003

User Details

Title	Mr.
First Name	
Last Name	
Telephone	0114655034
Mobile	+966599281826
Email	shahrukh@gulfcrite.com
Username	shahrukh@gulfcrite.com
Preferred Language	English (UK)
Time Zone	(GMT + 3:00) Kuwait, Riyadh, Doha, Manama

Contact List

Last Name	First Name	Email	Phone Number
1		shahrukh@gulfcrite.com	0114655034

Registration Date

Registration Date 30/06/2020

List of Forms

No Forms found

Path	Category Title	Last Modification Date	Status Summary	Assessments Present
1	Status Completed MAINTENANCE AND REPAIR FACILITY	11/01/2021	Assessment Status not visible	0
2	Status Completed ADHESIVE AND SEALANTS	11/01/2021	Assessment Status not visible	1
3	Status Completed INTERIOR FINISHING	11/01/2021	Assessment Status not visible	1
4	Status Completed OPERATION AND MAINTINANCE	11/01/2021	Assessment Status not visible	1
5	Status Completed FIRE FIGHTING SYSTEMS	11/01/2021	Assessment Status not visible	1
6	Status Completed CARGO HANDLING FACILITIES	11/01/2021	Assessment Status not visible	1
7	Status Completed TERMINAL	11/01/2021	Assessment Status not visible	1
8	Status Completed CAR PARKING	11/01/2021	Assessment Status not visible	1
9	Status Completed CIVIL WORKS	11/01/2021	Assessment Status not visible	1
10	Status Completed ROOFING MATERIALS	01/07/2020	Assessment Status not visible	1
11	Status Completed PAINTS & COATING SUPPLIES	01/07/2020	Assessment Status not visible	1
12	Status Completed METAL/STEEL STRUCTURE	01/07/2020	Assessment Status not visible	1

Path	Title	Date	Status Summary	Present
13	Status Completed AIRPORTS CONTRACTING	01/07/2020	Assessment Status not visible	1
14	Status Completed MAIN,MINOR SEWERAGE, NETWORK	11/01/2021	Assessment Status not visible	1
15	Status Completed CAR PARKING,OTHER SHADES STRCT	01/07/2020	Assessment Status not visible	1
16	Status Completed HANGERS,WAREHOUSE WORKS	01/07/2020	Assessment Status not visible	1
17	Status Completed MAIN ROADS,STREETS RELATED WRK	11/01/2021	Assessment Status not visible	1
18	Status Completed COOLANT AND ADDITIVES	01/07/2020	Assessment Status not visible	1
19	Status Completed ADHESIVE AND SEALANTS	01/07/2020	Assessment Status not visible	1
20	Status Completed INFRASTRUCTURE,BUILDING WORKS	01/07/2020	Assessment Status not visible	1
21	Status Completed GEOPHYSICAL	11/01/2021	Assessment Status not visible	1
22	Status Completed CAR PARKING SYSTEM	01/07/2020	Assessment Status not visible	1
23	Status Completed JOINTING,PACKING	11/01/2021	Assessment Status not visible	1
24	Status Completed VESSELS AND TANKS	01/07/2020	Assessment Status not visible	1
25	Status Completed DIGGING AND PILING WORKS	11/01/2021	Assessment Status not visible	1
26	Status Completed RESIDENT ENGINEERING SERVICES	11/01/2021	Assessment Status not visible	1
27	Status Completed MASONRY,STONE WORK TILE	01/07/2020	Assessment Status not visible	1
28	Status Completed MAINTENANCE SERVICES	11/01/2021	Assessment Status not visible	1
29	Status Completed MATERIALS	01/07/2020	Assessment Status not visible	1
30	Status Completed CLADDING WORKS	01/07/2020	Assessment Status not visible	1
31	Status Completed FORWARDING FACILITY	11/01/2021	Assessment Status not visible	1
32	Status Completed GENERAL WORKS	01/07/2020	Assessment Status not visible	1
33	Status Completed INDUSTRIAL WORKS	01/07/2020	Assessment Status not visible	1
34	Status Completed ROAD MARKINGS	01/07/2020	Assessment Status not visible	1
35	Status Completed EXTERIOR RENOVATION WORKS	11/01/2021	Assessment Status not visible	1
36	Status Completed INTERIOR RENOVATION WORKS	11/01/2021	Assessment Status not visible	1
37	Status Completed FIRE SUPPRESSION SYSTEMS	11/01/2021	Assessment Status not visible	1
38	Status Completed CARPET AND FLOORING	11/01/2021	Assessment Status not visible	1
39	Status Completed TOPOGRAPHIC & OTHER	11/01/2021	Assessment Status not visible	1
40	Status Completed PAINT	01/07/2020	Assessment Status not visible	0
41	Status Completed SEALANT	11/01/2021	Assessment Status not visible	0
42	Status Completed SEALER	11/01/2021	Assessment Status not visible	0
43	Status Completed SEAL	11/01/2021	Assessment Status not visible	0
44	Status Completed JOINT	11/01/2021	Assessment Status not visible	0
45	Status Completed INSULATION	01/07/2020	Assessment Status not visible	0

No Segmentation Assessment found

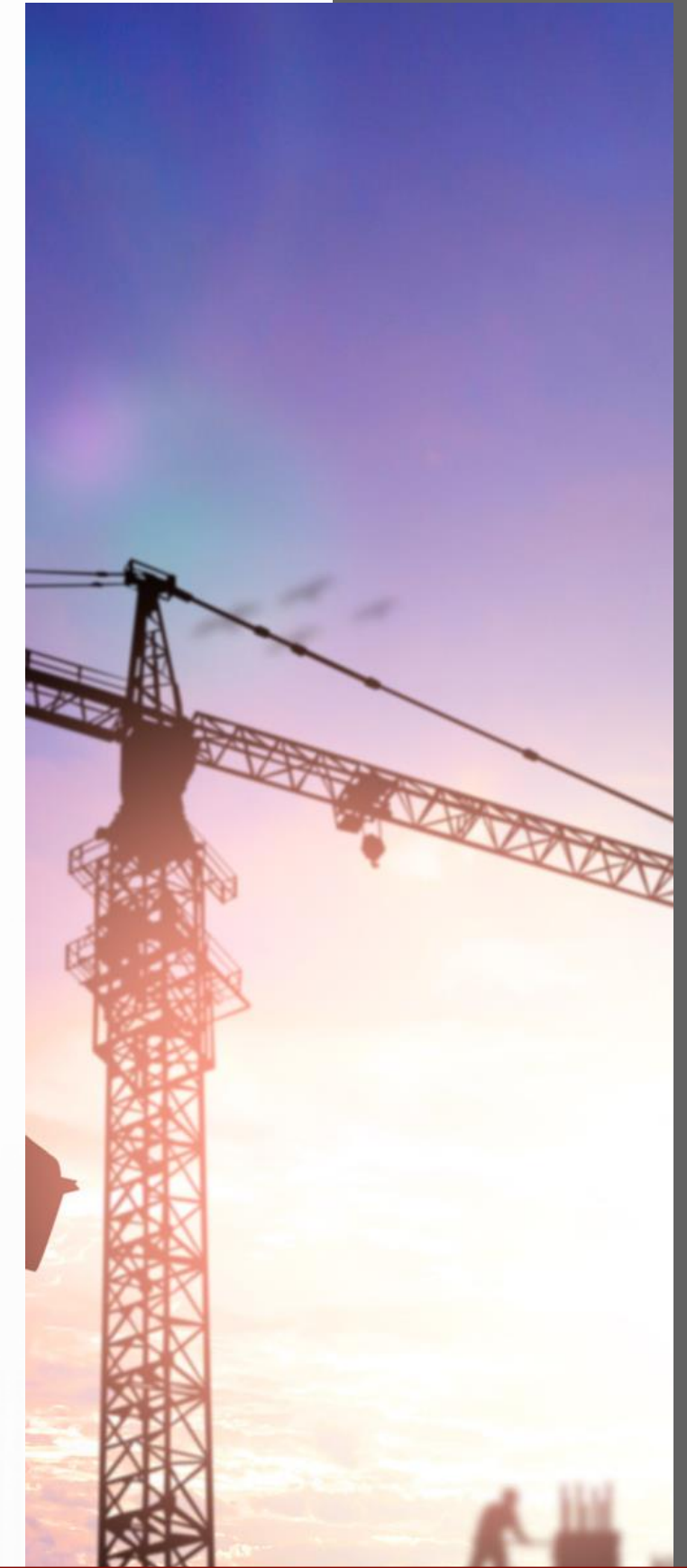

# CERTIFICATION



**GULF CRETE LTD.**  
IS AN  
**APPROVED APPLICATOR**  
OF FLOWCRETE PRODUCTS

Deckshield, Isocrete, Flowfresh, Flowfast, Mondeco and Other Epoxy Systems but not limited to coatings, Screeds and Multi-Layer Systems

For the period of: 01/01/2019 To: 31/12/2019

Signed: \_\_\_\_\_

Mayur Agarwal | Regional Sales Manager – StonCor ME Flooring Business Unit

StonCor Middle East LLC  
PO BOX 3034  
Al Quoz Industrial Area Dubai UAE  
Tel: +971 4 347 0460 | Fax: +971 4 347 0242  
Email: [una@flowcrete.com](mailto:una@flowcrete.com)

Flowcrete in the Middle East is manufactured & sold by StonCor Middle East LLC under License from Flowcrete UK.



[www.flowcrete.ae](http://www.flowcrete.ae)





CERTIFICATION

**CENTRO HOTEL, RIYADH**  
Document Submittal

**TITLE:** PQD OF GULF CRETE LTD. CONTRACTING COMPANY      **SUBMITTAL NO.:** DS-PQD-CR-014-AR-29

**TO:** Mr : Khatib and Alami      **REV. NO.:** 00

**FROM:**      **DATE:** 28-10-2014

**ATTN:** Engr. Safwan Al Futaieh      **ORIG. REF:**

**TYPE OF SUBMITTAL**

SD - Shop Drawing       SMP - Samples       ABD - As Built Drawings

SCE - Program / Schedule       CRT - Certification, Verification       OMM - Operating & Maintenance Manuals

MST - Method Statement       PQD - Pre-Qualification       QPP - Quality Plans & Procedures

MUP - Mock Ups & QC Panels       TST - Test Reports       MPD - Product & Materials Data

OTH -Others:

**SUBMITTAL DISCIPLINE & DESCRIPTION**

C-Civil     S-Structural     A-Architectural     E-Electrical     M-Mechanical     G-General     O-Coordination

I-Interior Design     L-Landscape     F-Fit-Out    Attachments: 1 (PQD - Submittal)

**SPECIFICATION & BOQ REF.:**      Location / Use:      Site:

**SUBMITTED FOR**

A-Approval     R-Review & Comments     Q-As Requested     I-Information / Records Only     N-Action     O-Others

**Submitted By Contractor's Rep.:** Engr. NICOLAS HADDAD      **Signature:** \_\_\_\_\_

**PROJECT MANAGEMENT REVIEW (If Required)**

**Name:** \_\_\_\_\_ **Signature:** \_\_\_\_\_ **Date:** \_\_\_\_\_

**CLIENT'S COMMENTS (If Any)**

**Name:** \_\_\_\_\_ **Signature:** \_\_\_\_\_ **Date:** \_\_\_\_\_

**SUPERVISION CONSULTANT'S COMMENT**

A-Approved     B-Approved with Comments (When May Proceed - Incorporate Comments & Resubmit Within ..... Days)     C-Reviewed With Comments. Revise / Resubmit     D-Rejected

**Comments:**

- Must be adhered to the contractual documents, specifications and B.O.Q.

- Must be qualified and certified for the application of the approval materials (all documents and certificates must be submitted for consultant's review)

- Certificate of warranty (at least 50 years) must be sent to consultant.

- The company and S.C.C. are responsible for the perfect application of these materials with following epoxy paint. The company must check, rectify and complete all preparation works for any area before start these materials.

**DATE RECEIVED:** \_\_\_\_\_ **DATE RETURNED:** 28/10/14

**SUPERVISION CONSULTANT'S SIGNATURE**

For & On behalf of Khatib & Alami (Project Manager):

**Name:** Engr. Safwan Al Futaieh      **Signature:** \_\_\_\_\_ **Date:** \_\_\_\_\_



CERTIFICATION

Damman University  
Dammam, Kingdom of Saudi Arabia  
Project : Administration Building & Multi purpose Hall

**Pre-qualification Submittal**

**TRADE :** CIVIL /STRUCTURAL      **Submittal No.:** 120-B-PRO-S-83      **Revision No.:** 0

**Specs. Code & Ref.:** 09-900IE      **B.O.Q. Code Ref.:** 5-1      **Building No.:** 120      **Date Submitted:** 13-09-15

**Date Returned:**

Item no.	Description	Submitted for :
	PAINT APPLICATOR FOR STEEL STRUCTURE	Approval <input type="checkbox"/> Information <input type="checkbox"/> Coordination <input type="checkbox"/> Review <input type="checkbox"/>
	GULF CRETE LTD. CONTRACTING COMPANY	Trade: <input type="checkbox"/> Structural <input type="checkbox"/> Architectural <input type="checkbox"/> Mechanical / Plumbing <input type="checkbox"/> Electrical <input type="checkbox"/> Attachment: <input type="checkbox"/> Certificates <input type="checkbox"/> Technical Brochure <input type="checkbox"/> Manufacturer's Data & Specs. <input type="checkbox"/> Shop Drawings <input type="checkbox"/> Sample <input type="checkbox"/> Catalogue <input type="checkbox"/> Company Profile <input type="checkbox"/> AS Built Drawings <input type="checkbox"/> Warranty <input type="checkbox"/> Others (Specify) <input type="checkbox"/>

**Prepared by:** Engr. Hassan Shehata, Senior QA/QC Engineer      **Checked by:** Engr. Mohamed Eleawa, Acting QA/QC Manager      **Noted by:** Engr. Mahmoud Abdul Azim, Construction Manager

**FOR Consultant USE ONLY:**      **Received by:** \_\_\_\_\_

**Remarks:** لا مانع من هذا العقد الشروط طبقا لتوقيت المالك  
وذلك طبقا للمالك  
بموجب الشروط المتوقعة من المورد والمقيد بها لانها  
تجسد التطبيق طبقا لتوصيات المورد والمواد المستخدمة ونفقات الاستلام  
بمجرد اتمام حوامل العمل والبدء في تنفيذ طبقات الاسفلت والسلامة  
المرفقة بتفصيل

**ACTION taken:**

A-Approved     B-Approved with comments     C-Approved with comments (Resubmit)     D-Rejected

**Project Manager:** Engr. Ashraf Tantawy      **Resident Engineer:** \_\_\_\_\_

**OWNER:** \_\_\_\_\_      **CONSULTANT:** \_\_\_\_\_      **CONTRACTOR:** \_\_\_\_\_

**Contractor's Signature:** \_\_\_\_\_ **Date:** \_\_\_\_\_





CERTIFICATION



شركة بي إي إس إف السعودية - نواد البناء المحدودة  
 برج العمال الطابق رقم 11  
 طريق الملك سعود التقيلة ، الطويران 2122  
 ص.ب 1884 الخبر 31952 - المملكة العربية السعودية  
 Saudi BASF For Building Materials Co. Ltd.  
 Al-Othman Business Tower 14th Floor  
 King Saudi Road, Al-Qashshah, Dhahran 34232  
 P.O. Box 1884, Al-Khobar 31952

26<sup>th</sup> February 2017  
 Ref:JT/L001/26022017

**PRE – QUALIFICATION CERTIFICATE OF CONFIRMITY**

This is to acknowledge that **M/S Gulf Crete Ltd. Contracting Company.** Has submitted company profile and other relevant documents to SAUDI BASF, For Building Materials Co Ltd for authorized applicator approval purpose. Hereby we are certifying that they are under review and authorized to apply our products as below.

- WATERPROOFING SYSTEMS
- Epoxy and PU flooring system
- Concrete Repair

Further to their team of supervisor had maintained good quality work. Hence, they are prequalified applicators to the Saudi BASF range of products as described above.

The pre-qualification is valid for one year from this date and subject to remain under constant monitoring for using Saudi BASF – The Chemical Company products. This pre-qualification can be withdrawn, if the quality of application is not to BASF's satisfaction.

For and on Behalf of  
 Saudi BASF Co.Ltd.

**Jignesh Thakkar.**  
 Technical Manager

شركة بي إي إس إف السعودية نواد البناء المحدودة  
 Saudi BASF  
 for Building Mts. Co. Ltd.  
 قسم المختبرات والجودة  
 Technical Department

المكتب الرئيسي:  
 هاتف: +966 13 853 8600, 13 812 1140  
 فاكس: +966 13 852 8671, 13 812 1822  
 www.master-builders-solutions.sa  
 enquiry@saudi.basf.com



شركة ذات مسئولية محدودة في المملكة العربية السعودية رأس المال المدفوع 11 مليون ريال سجل تجاري رقم 2000007690  
 السجل الممثل طريق رقم 58 المنطقة الصناعية الثالثة، الدمام، المملكة العربية السعودية هاتف: +966 13 812 1231 فاكس: +966 13 812 3259  
 A private Company incorporated with limited liability in the KSA, Paid Up Share Capital SR 11 Million, Commercial Registration No. 2000007690  
 Registered Office, Street No 58, Dammam 2nd Industrial Area, Saudi Arabia, Tel : +966 13 812 1231, Fax : +966 13 812 3259



Ref : AY/06/22

Date: June 21, 2022.

**TO WHOM IT MAY CONCERN**

This is to certify that **M/s. Gulferete** have considered as our certified and approved applicator for following Fosam Products' Range as below:

- Concrete Repair.
- Protective Coatings.
- Industrial Flooring.
- Joint Sealants.

This certificate is issued upon their request without any liabilities on Fosam Company Limited and valid for six months from the date of issuance of this certificate.

Yours sincerely,  
 For **Fosam Company Limited**



Fosam Company Limited  
 Head Office  
 PO Box 11081  
 Jeddah - 21452  
 Saudi Arabia  
 C.R. No 31273  
 Paid up Capital: SR3,000,000  
 www.fosroc.com

الهاتف: +966 21 831 8522  
 الفاكس: +966 21 831 8531  
 البريد الإلكتروني: info@fosroc.com





CERTIFICATION



شركة دي سي بي السعودية

Date: 22<sup>nd</sup> November 2014

TO WHOM IT MAY CONCERN

This is to certify that **M/s Gulf Crete Ltd.** is our approved and certified applicator for all DCP Saudi Company Products for following ranges:

- Waterproofing system
- Joint Sealant
- Protective coating for concrete and masonry
- Epoxy Flooring
- Concrete repair
- Injection

This certificate is issued upon their request and without any liabilities on DCP Saudi Company, and valid for Six months from the date of issuance of this certificate.

Yours Sincerely,



For  
DCP Saudi Co.

**DCP Saudi**  
PO Box 60241 Alqadh 11376  
Kingdom of Saudi Arabia  
Tel. + 966 11 461 2000  
Fax. + 966 11 279 2009  
Info.saudi@dcg-ltd.com  
www.dcp-ltd.com



experience quality full range

Capital Paid: 1000000 S.R CR. # 1010267930 Licence: 217074 رقم الترخيص: ٢١٧٠٧٤ ١٠١٠٢٦٧٩٣٠ ريال سعودي ١٠٠٠٠٠٠ رأس المال المدفوع



CERTIFICATION

## CERTIFICATE

FOR RECOMMENDED SIKA APPLICATORS

This is to certify that

### GULF CRETE CONTRACTING

Has successfully executed many Projects after having passed the application training of various Sika systems and is Recommended Sika Applicator for

**Concrete repair and protection, Waterproofing (PVC membranes loose laid and full compartment system), Cementitious, Resins, Combiflex range), Joint Sealants and Industrial flooring.**

This comprehensive training consisted of practical instructions about proper storage, preparation and application of Sika products.

The recommended applicator has been provided with the relevant Sika Product Data Sheets and all other technical documentation.

This confirmation is valid until the date of expiry below and may be renewed subject to the Recommended Applicator successfully completing any training courses required by Sika. The Recommended Applicator is responsible for ensuring full compliance by its employees with Sika's guidelines, training instructions and any other requirements of third parties.

Sika is not responsible for any loss or damage suffered by any third party as a result of any acts or omissions of the Recommended Applicator arising in anyway, including but not limited to breach of contract, misrepresentation, failure to comply with applicable laws or any other tort including negligence.

Sika Saudi Arabia,

Issuing Date: January 01, 2016

Expiry Date: December 31, 2016



**Shehadeh Salman**  
T.M Waterproofing Manager  
Central Region  
Sika Saudi Arabia





**Emad Al Asqar**  
Sr. Sales Manager  
Central Region  
Sika Saudi Arabia

This Recommendation does not assume responsibility for the correct storage, mixing or use of these Products. Sika shall not be liable for damage to persons or property, loss of business or profit or any other direct, indirect, incidental, special or consequential damage so caused by the Recommended Applicator. Sika shall also not be responsible for use of these Products in a manner to infringe on any patent or other intellectual property rights held by others. Sika's liability is limited to the quality only of the supplied material. Any failures due to wrong application or storage not in accordance with the given guidelines as stated on the latest Technical Data Sheets, as well as structural or mechanical failures are excluded herein.

BUILDING TRUST







CERTIFICATION



constructive solutions

Ref : KR/0513/05  
Date : 22<sup>nd</sup> November 2014

**TO WHOM IT MAY CONCERN**

This is to certify that **M/s. Gulf Crete LTD.** is our approved and certified applicators for all Fosam Products for the following range of applications:

- Joint sealing works.
- Specialized protective coating for concrete and masonry.
- Epoxy Flooring
- Concrete Repair

This certificate is issued upon their request and without any liabilities on Fosam Company Limited and valid for three months from the date of issuance of this certificate.

Yours sincerely,  
For **Fosam Company Limited**

**Kareem Rabayah**  
Area Sales Manager-Central Region  
Mobile: 0553829272



شركة فوسام المحدودة  
Fosam Company Limited  
مس. 50391 - الرياض 11523  
C.R. No. 31273 - P.O. Box 50391 Riyadh  
Tlx: 4029033 - 8454414

Fosam Company Limited  
Riyadh Office  
P.O. Box 50391  
Riyadh - 11523  
C.R. No. 31273  
Paid up Capital: SR 3,000,000  
www.fosroc.com

Telephone: 00 966 1 482 9303    Fax: 00 966 1 482 7962    e-mail: fosam\_riyadh@fosroc.com

Registered Office: Building No.153, Takasul Road, North Mawther

CERTIFICATION

## Sika Saudi Arabia Co. Ltd.

شركة سيكا العربية السعودية المحدودة

### CERTIFICATE

This is to confirm that **Gulf Crete LTD Co.**  
P O Box 20647  
Riyadh 11465  
Is an approved applicator for the following applications of Sika®-Products.  
**PVC Membrane, Cementitious & Epoxy Waterproofing**

The Approved Applicator **Gulf Crete** has received practical training in the proper storing, preparation and application of the Sika®-Products.

The approved Applicator is aware of the relevant Sika® Product Data Sheets and all other technical documentation.

This Confirmation is valid for one year from its date of issue and may be renewed subject to the Approved Applicator successfully completing any training courses required by Sika. Sika is not responsible for the Approved Applicator's compliance with Sika's guidelines or training instructions or any other requirements of third parties. Sika is not liable for any acts or omissions of the Approved Applicator arising in any way, including, but not limited to, any breach of contract; or any distort (including negligence); or any breach of statutory duty.

**THIS CERTIFICATE IS VALID FOR THE PERIOD 01/06/14 TO 01/06/2015**

Sincerely,  
  
**Emad Al Ashqar,**  
Senior Sales Manager,  
Sika Saudi Arabia,  
Riyadh,  
Mobile # 0505 363 569





**Jeddah**  
P. O. Box 112356  
Jeddah 21371  
Saudi Arabia  
Tel: +966-2- 8927879  
Fax: +966-2- 8921272  
C.R. No: 4022023486  
sika.jeddah@sika.com

**Dammam**  
P.O.Box 74577  
Dammam 31952  
Saudi Arabia  
Tel: +966-3-8472448  
Fax: +966-3-8471763  
sika.dammam@sika.com

**Riyadh**  
P.O.Box 58647  
Riyadh 11583  
Saudi Arabia  
Tel: +966-6-11102230  
Fax: +966-6-11102281  
sika.riyadh@sika.com

Innovation & Consistency | since 1910





CERTIFICATION

CONSULTANT <b>Omrania</b>	CLIENT مركز الملك سلمان للإيواء King Salman Center for Disability Research Building Rehabilitation Project	CONTRACTOR STRATEGIC DEVELOPMENT COMPANY DESIGN & BUILD
PROJECT Radisson Blu Hotel/Furnished Apartments DG, Riyadh		
<b>SUB-CONTRACTOR PREQUALIFICATION SUBMITTAL</b>		
Ref No: <b>C/PQ-A/141</b>	R/O	Date: <b>26 OCT 2015</b>
<input checked="" type="checkbox"/> New Submittal <input type="checkbox"/> Resubmittal		
<input checked="" type="checkbox"/> Architectural <input type="checkbox"/> Electrical <input type="checkbox"/> Civil <input type="checkbox"/> Furniture/Equipment <input type="checkbox"/> Structural <input type="checkbox"/> Mechanical <input type="checkbox"/> Interior Design <input type="checkbox"/> Others		
Description: <b>EPOXY APPLICATOR</b>		
PREQUALIFICATION FOR (GULF CRETE LTD.) KSA 2+ CD (B)		
*Description: (Manufacturer, Model, Type, Size, Color, etc.) <input type="checkbox"/> Catalogue <input type="checkbox"/> Drawing <input type="checkbox"/> Sample <input type="checkbox"/> Calculation <input checked="" type="checkbox"/> Document		
Having checked this submittal, we certify that it conforms to the requirements of the contract documents in all respects, except as otherwise indicated herein.		
Material Engineer Name & Signature: <i>[Signature]</i>		Project Manager Name & Signature: <i>[Signature]</i>
Received by: _____		
Date: _____ Name & Signature of Consultant: _____		
Remarks / Comments: - The prequalification of sub-contractor GULF CRETE LTD. "epoxy applicator" is approved. - Mock-up sample as per contract is required for final approval.		
RECEIVED 10 NOV 2015 <i>[Signature]</i>		
Status: <input checked="" type="checkbox"/> Approved <input type="checkbox"/> Approved as noted <input type="checkbox"/> Rejected - Resubmit <input type="checkbox"/> Revise & Resubmit, Work shall not proceed <input type="checkbox"/> No Action		
Engineer: <i>[Signature]</i> Date: 05.11.2015	Project Manager: <i>[Signature]</i>	Consultant Head Office: <i>[Signature]</i>



CERTIFICATION

Consultant	Owner King Saud University	Contractor Shargawi Electro-Mechanical Company Shargawi Co.
PROJECT NO: KSUE - BUILDING I No. 8		LOCATION: Internal and External
<b>SUBCONTRACTOR SUBMITTAL</b>		
<input checked="" type="checkbox"/> NEW SUBMITTAL	SUBMITTAL No: AR-08-01	PREV SUBMITTAL NO:
<input type="checkbox"/> RESUBMITTAL	DATE: 07/12/2016	PREV SUBMITTAL DATE:
Submittal reason: <input type="checkbox"/> INFO <input type="checkbox"/> NOTES <input checked="" type="checkbox"/> APPROVAL		
Major: <input type="checkbox"/> CV <input checked="" type="checkbox"/> AR <input type="checkbox"/> ST <input type="checkbox"/> AC <input type="checkbox"/> EL <input type="checkbox"/> PL <input type="checkbox"/> OTHER		
Attachments: <input checked="" type="checkbox"/> Brochure <input checked="" type="checkbox"/> Tech. info <input checked="" type="checkbox"/> Sample <input checked="" type="checkbox"/> Certificate <input type="checkbox"/> Drawing <input type="checkbox"/> Calculations		
Materials/Tools		
Serial	Subcontractor Name, Number & Description	Source    Supplier / Manufacturer    Specs Ref    Code Status
1	GULF CRETE LTD	KSA    APPLICATOR FOR EPOXY COATING       B
2		
3		
4		
5		
6		
<b>CONTRACTOR</b>		
Procurement Manager Name: _____ Signature: _____		Project Manager Name: Ayman Shaban    Site Engineer: Ammar Khaled Signature: <i>[Signature]</i> <i>[Signature]</i>
<b>CONSULTANT NOTES</b> Approved as epoxy applicator.		
<b>CONSULTANT</b> Name: Mohamed Toth Position: Consultant Engineer Signature: _____ Date: Dec 10 2016		<b>STRATEGIC CONSTRUCTION PROGRAM</b> Signature: _____ ENG. KHALID FAHD AL-SHAIDDI General Manager of Strategic Construction Program
<b>APPROVAL SITUATION</b>		
<input checked="" type="checkbox"/> APPROVED		<input type="checkbox"/> REJECTED
<input checked="" type="checkbox"/> APP WITH COMMENTS		<input type="checkbox"/> NO ACTION
<input type="checkbox"/> APP. AS NOTED/RESUBMITTAL REQUIRED		
INCOMING: SIGNATURE: _____ DATE: _____	OUTGOING: SIGNATURE: _____ DATE: _____	







CERTIFICATION

**BASF**  
The Chemical Company

Saudi BASF For Building Materials Co. Ltd. PO Box 1884 Al-Khobar 31952 KSA  
شركة ام بي سي السعودية  
For Building Materials Co. Ltd.  
P.O. Box 1884  
Al-Khobar 31952  
Kingdom of Saudi Arabia

18<sup>th</sup> OCTOBER 2015  
Ref. RUH/AI/0050-15

Head Office  
Tel: +966 3 8121140  
Fax: +966 3 8121822  
www.mot-saudi-arabia.com  
inquiry@saudi@bassf.com

M/s. GULF CRETE

**PRE – QUALIFICATION CERTIFICATE OF CONFORMITY**

This is to certify that M/s GULF CRETE had worked with Saudi BASF range of products with the following product groups:

- Epoxy & PU Flooring systems
- Waterproofing systems
- Concrete repair

Their Team of supervisor had so far demonstrated good quality work in application and workmanship. Hence, they are granted as pre-qualified applicator for the Saudi BASF range of products as described above.



This pre-qualification is valid for one year from this date and subject to remain under constant monitoring for using Saudi BASF - The Chemical Company products. This pre-qualification can be withdrawn during the duration of this period, if the quality of application is not to BASF's Standards and Guidelines.

For and on behalf of  
Saudi BASF Co. Ltd.

  
Technical Manager



A Private Company incorporated with limited liability in the Kingdom of Saudi Arabia  
Paid up Share Capital SR 5.5 Million  
Commercial Registration No. 2050027E20  
COC Membership No. 478



CERTIFICATION

  
JOTUN SAUDIA

**Facsimile**

To :- CC	Engr. Fathi AL-Kosa	Date: 02 January 2014 Facsimile :011 4775771 011 4776484
Company :	Gulf Crete Co.	No. of pages : 1
From (Name):	Engr. Yasser Abdul - Hadi	Tel. # 01 2445883
Company :	Jotun Saudia Co. Ltd., Riyadh	Fax # 01 270 9689
Subject :	<b>APPROVED APPLICATOR</b>	

With reference to the above subject we would like to inform you that, M/S Gulf Crete Co., have adequate experience in application our Protective Coatings in Saudia Arabia like floor coating , fire proofing coating & high performance coating. They are one of our approved coating applicators.  
This certificate does not imply any responsibility on our part for quality control of workmanship or any contractual liabilities.

This is for your kind information.

Thank you & best regards,

  
**Yasser Abdul-Hadi**  
Area Sales Manager.  
Jotun Paints-Riyadh  
Mobile : 0559416947  
Tel: 01 2445883 – Exit.1610  
Fax: 01 270 9689













**CENTRAL PROJECTS DEPARTMENT  
CENTRAL SUBSTATION PROJECTS DIVISION  
REVIEW OF CONTRACTOR'S SUBMITTAL**

 الشركة السعودية للكهرباء  
 Saudi Electricity Company  
 نعمل بإنفاق من أجلكم

Submittal No.	9049/CSPD/SEPCOIII-L-0594-R0	Date:	18 February, 2021
CONTRACT NO.:	4400012943	CONTRACTOR:	SEPCOIII
BUDGET ITEM NO.		JOB ORDER NO.:	1-1911052.01
PROJECT TITLE : CONSTRUCTION OF LAYLA ( 9049 ) 380/132 kV BSP			
TO :	Department Manager, SEC-Central 2 <sup>nd</sup> Floor, Building-C, Rihana Bint Zaid Street, Al Arid Riyadh-KSA Tel : (01) 8077872	From :	( Contractor ) SEPCOIII ELECTRIC POWER CONSTRUCTION CO.LTD.BRANCH
<b>ACCEPTANCE OF THE FOLLOWING SUBMITTAL IS HEREBY REQUESTED:</b>			
Check in the Appropriate Box: <input type="checkbox"/> Drawings/Sketches <input type="checkbox"/> Materials/Equipment <input type="checkbox"/> Test Reports			
<input type="checkbox"/> Manual <input type="checkbox"/> Reminder <input type="checkbox"/> Weekly/Monthly Report <input checked="" type="checkbox"/> Submittal <i>Others (Specify)</i> _____			
<b>FILL-UP APPLICABLE INFORMATION BELOW:</b>			
Description	: <b>Submission of " Epoxy Applicator For Self Levelling Epoxy Coating (SPECIALIST TRADING CORP &amp; CONTRACTING ) &amp; (Gulf Crete Ltd. ) "</b> for <b>Substation Layla (9049) 380/132kV BSP.</b>		
Reference Specification	:		
Manufacturer/Supplier	: <b>S.T.C /GULF CRETE LTD</b>		
Drawing Number	:		
Expected Delivery Time	:		
COMPLYING WITH SCOPE OF WORK AND TECHNICAL SPECIFICATIONS? <input checked="" type="checkbox"/> YES <input type="checkbox"/> No			
IF "NO" INDICATE DEVIATIONS: (Provide justification and attach supporting documents)			
Contractor	Project Manager	SEC	Engineer
Signature : 		Received by : Civil Team Head	
Name : Eng'r. Zhu Hailin		Signature : 	
Date : 18 / 2 / 2021		Name : <b>Engr. Nino Celestial Baliguat Baldestamon</b>	
		Date : 18-FEBRUARY-2021	
<b>FOR SEC USE ONLY</b>			
SEC HAVE REVIEWED THE ABOVE SUBMITTAL AND FOUND IT:		Remarks:	
<input type="checkbox"/> A: Acceptable <input checked="" type="checkbox"/> B: Acceptable EXCEPT AS NOTED <input type="checkbox"/> C: Not Acceptable (Resubmit) <input checked="" type="checkbox"/> See Attached Sheet <input checked="" type="checkbox"/> Provide Additional Information		REFER ATTACHMENT FOR COMMENTS ***** NOTHING FOLLOWS*****	
<b>Project Department Group Leader Civil</b>		<b>(Contractor)</b>	
Signature : 		Received by	
Name : Eng'r. Mohammed Al-Khaldi		Signature :	
Ref. No : 21/MAA-2-49-375/12021001		Name :	
Date : 21-FEBRUARY-2021		Date :	
<b>Note:</b> Acceptance does not release the Contractor from his responsibilities in performing the work in strict conformance with Contract, Scope of Work and Technical Specification			











**SUBCONTRACTOR PREQUALIFICATION SUBMITTAL FORM**

Submittal Ref.	KSP-FHJ-INW-CMT-CIV-PQD-0140	Revision	01	Date	14-Marc-2022
Program	King Salman Park				
Project	CP03 Infrastructure Works Phase 1 & O&M Center	Project No.	CP03		
Client	King Salman Park Foundation (KSPF)				
PMO	Saudi Arabian Parsons Ltd. (SAPL)	Contractor	Freysinet-Haif JV (FHJ)		
PMC	Faithful Gould (FGS)	PMCM			

Discipline  Civil  Architecture  Mechanical  Electrical  Information Technology  
 Landscape  Others: C

Sub-Contractor / Supplier Details	Attachments	P / x
Name: GULF CERTE – Riyadh (APPLICATOR)	Chamber of Commerce Membership.	Y
Trade: All type of Water Proofing & Thermal Insulation (APPLICATOR)		
Location: Riyadh KSA	Municipality License	Y
Experience (Total No. of Years): 30 Years	Other Licenses (Specify):	Y
Experience in KSA: 30 Years	Please refer to PQD documents.	
Contact Name: GULF CERTE Head Office Riyadh Mobile Number: 966 599281826 (Shah Rukh Ali Hassan)		
Is the company certified against any quality standard? Yes	Pre-Qualification Doc's (Specify):	Y
Is the company certified against any Health & Safety and Environment standard? Yes	Please refer to PQD documents.	
<b>Subcontractors / Supplier's Proposed Scope of Work in this project</b>		
- Waterproofing & Damp proofing – EPDM – TPO- FPO – POLYUREA - Spray Polyurethane foam Waterproofing - Geosynthetic Engineering - Concrete Repair and Protection – injection work - Building Renovations - Expansion joint – fire proof – decorative and protective epoxy coating - Stamped Concrete - Light Weight Foam Concrete		
	Completion Certificates for Previous Projects	Y

Contractor Signatures & Stamp			
Discipline Engineer	QA/ QC	HSE	Construction Manager
			
 KING SALMAN PARK MEP HAIF COMPANY - FREYSSINET SA			

Submittal Status:  
 A - Approved  B - Approved as Noted  C - Revise and Resubmit  D - Rejected

Engineer's Comments: Complied our previous comments, contractor to keep all the documentation updated.

PMO/Client' Comments:

Name	Signature	Date

Subcontractor Prequalification Submittal Form  
KSP-FGS-GEN-PMC-PRO-TEM-xxxx | xx | xx-xx-xxxx





Doc No: DG-DSQ-314-0000-NSM-PQQ-PR-000108  
 Revision: 02  
 Date: 28 July 2022  
 Page: 1 of 2



## (DRF) Document Review Form (PQQ)

### Part 1 – Issue / Receive / Distribute

**Employer :** Diriyah Gate Development Authority  
**Contractor :** NESMA & PARTNERS CONT. CO. LTD.  
**Project :** 314-DSQ Tunnels and Gytratory (Under WRR)  
**Contract/ Work Package :** DG1/DG/DSQ/314-DSQ Tunnels and Gytratory (Under WRR)  
**Construction Supervisor :** AECOM

Document Type	Document Reference
Pre-Qualification / Subcontractor	DG-DSQ-314-0000-NSM-PQQ-PR-000108(02)

Document Description	
<b>Title</b>	Prequalification Submittal for M/S GULF CRETE LTD Co. For SHOTCRETE
<b>Package:</b>	DD-2020-280
<b>Discipline:</b>	CE-CIVIL
<b>Work Location:</b>	DG1/DG/DSQ/314-DSQ Tunnels and Gytratory (Under WRR)

**List of Attachments (If Any)**  
 Company profile, Table Content, Organization Chart, List of Projects, Chamber of Commerce Commercial Registrations, Gosi Certificate Saudization Certificate Iso Certificate, Zakat Certificate, Quality & HSE Plan Previous Approval Submittal,

Issued By: Contractor	
<b>Name:</b>	AYHAM BSHARA
<b>Date:</b>	28-07-2022
<b>Role:</b>	PROJECT MANAGER
<b>Signature &amp; Stamp:</b>	

### Part 2 – Review and Response

Review Comments (to be completed by the Construction Supervisor/ Consultant)

Classification | Internal

Doc No: DG-DSQ-314-0000-NSM-PQQ-PR-000108  
 Revision: 02  
 Date: 28 July 2022  
 Page: 2 of 2



Reviewed By: Consultant / Construction Supervisor	
<b>Name:</b>	Ebrahim Saif
<b>Date:</b>	01-08-2022
<b>Signature:</b>	

### Part 3 – Approval

A. Approved     B. Approved with Comments     C. Revise and Resubmit     D. Rejected

Approved By: Consultant / Construction Supervisor	
<b>Name:</b>	SAMER ODEH
<b>Role:</b>	RESIDENT ENGINEER
<b>Signature:</b>	

Classification | Internal



## APPROVED APPLICATOR CERTIFICATE

**GULF CRETE CO.**

This is to advise that, **M/S GULF CRETE CO.** has been registered as an approved applicator and the company demonstrated competence in applying the following Master Builders Solutions Saudi Arabia product/s range below:

- » **Epoxy & PU Flooring Systems**
- » **Waterproofing system**
- » **Concrete Repair**

This certificate has been issued upon the request of **GULF CRETE CO.** without having any liability on Master Builders Solutions Saudi Arabia. It is the sole responsibility of **GULF CRETE CO.** to strictly follow the written Method Statement, use proper tools/equipment and maintain good workmanship while applying the products.

This certificate is valid for **6 months** from this date and Master Builders Solutions Saudi Arabia reserve the right to cancel / withdraw the certificate any time if the application of the products is not in line with our written Method Statement. In the occurrence of the above, this certificate become null and void.

For and on behalf of  
Master Builders Solutions Saudi Arabia for Manufacturing LLC



Prasad Anandu Warkar  
Quality Manager

Date : 19<sup>th</sup> June 2022  
Ref. No. : AA/PW/030/2022





PROJECT / PARCEL		Area 1 - CL J01- Parcel 504			PROGRAMME No.		KAFD 0112		
OCS NUMBER		KAFD-A1-504-SAB-COM-PQD-00001-R3		Rev.	03	DATE		26-May-21	
ORIGINATOR		SAB			TRANSMITTAL No. / DATE		WF-000389 QAQC		
DOCUMENT No.		KAFD-A1-504-SAB-COM-PQD-00001-R3		Rev.	03	DISCIPLINE		Structure	
DOCUMENT TITLE		OCS - J01-P504-PQD-Structural Strength work for columns (Retrofitting) and repair (Gulf Crete Ltd) KAFD-A1-504-SAB-COM-PQD-00001-R3			DOCUMENT TYPE		PQD		
Comments / Replies Legends & Status				Comment Code Legend (for individual comments): 1 = Action Required; 2 = Note / Advisory / Recommendation			Reply Code Legend: i = Incorporated; ii = Not incorporated for reason stated in reply		Open / Closed
No.	Initial	Page / Section / Sheet	Comment Code	Reviewer Comment	Reply Code	Originator Reply		Reply Status by Reviewer	
1	MI	Gen	2	Years of Experience: 20 Years (Operating Experience in KSA)					
2	MI	Gen	2	JASARA PQD form is attached. Commercial registration certificate from Ministry of commerce attached and valid, ZAKAT & Tax Certificate attached and valid, GOSI certificate attached and valid.					
3	MI	Gen	2	Chamber of commerce (attached in hard copy)- valid, VAT Registration Certificate attached , Saudization Certificate attached and valid.					
4	MI	Gen	2	List of Previous Projects with documented evidences such as List of Partnerships & Valued Costumers, Major Projects & References are attached. Customers Approval and certificates from clients for completed works are included.					
5	MI	Gen	2	ISO Certificates provided , Quality Management System (QMS) is attached, HSE Policy & Manual is attached, Key Management and Company Organizational Chart attached, Technical Resources CVs are attached.					
6	MI	Gen	2	Contractor submitted Training certificates of applicators for CFRP jacketing works, Previous Project list accomplished for CFRP works attached, Attached Method statement of CFRP from supplier, Attached Test reports of CFRP, Attached Approvals from clients					
6	MI	Gen	2	Comments are made on the documents as presented. The content remains the responsibility of the author in all respects					
7	MI	Gen	1	Acceptance of the PQD is subjected to JLL approval					
Review Status Code:			B	A-Approved		B - Approved with Comments		C - Objection	
				D - No Objection		E - No Objection with Comments			
Reviewer Name(s) / Initials		Position	Supervision Consultant (SC)		Project Management-Construction Management (PMCM)		Programme Management Office (PMO)		Originator
Mohammed Imranuddin (MI)		Structural Engineer	COMMENTS / STATUS RECOMMENDED BY SC		COMMENTS / STATUS RECOMMENDED BY PMCM		COMMENTS / STATUS ADVISED BY PMO		REPLY APPROVED BY
			Name:	Paul Atkinson	Name:		Name:		Name:
			Position:	Project Director	Position:		Position:		Position:
			Signature:		Signature:		Signature:		Signature:
			Date:		Date:		Date:		Date:









الرقم: ١٤ / ١ / ١٤  
 التاريخ: ٢٠٢٠ / ٨ / ٣  
 المجلس الفيدرالي للمقاولين العربيين - الأمانة العامة  
 المملكة العربية السعودية - ص.ب ٧١٥٣ الرياض ١١٤٦٢  
 تلفون ٤٨٢٧٧٧٧ فاكس ٤٨٢٩٠٨٩

(( شهادة إنجاز ))

رقم التعميد	4700000078	التاريخ	2020/05/22م
المعهد	شركة خليج الغرسانة		
بشان	تنفيذ أعمال التدميم الانشائي لقرن سكن معالي الامين العام		
تاريخ الاستلام	2020/08/02م		
الملاحظات	لا يوجد		

مدير إدارة الخدمات العامة  
 خالد عبدالله المبارك

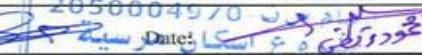
قسم المشاريع الهندسية والخدمات الفنية  
 م/ بدر عبدالعزيز الهومي

							
Client : National Housing Company		PMC : Dar al-handasah		Consultant : Khatib & Alami		General Contractor : Tamimi Global Company Ltd.	
<b>SUPPLIER PRE-QUALIFICATION</b>							
AR	ME	CV	LA	Submittal No.	S	P	-
ST	EE	QS	OT	Date : 7/13/2020	1	2	4
To: Khatib & Alami				From: Tamimi Global Company Ltd.			
Supplier Description				Attachments			
Name: GULF CRETE LTD THE SPECIALIZED CO.				<input checked="" type="checkbox"/> Company Profile			
Telephone No.: 0114655034				<input checked="" type="checkbox"/> Valid Commercial Registration Certificate			
Address: RIYADH-KSA				<input checked="" type="checkbox"/> Valid Membership of Chamber of Commerce			
Person in Charge and His Mobile No: 599281826				<input checked="" type="checkbox"/> Valid VAT Registration Certificate			
Supplier's Qualifying Log:				<input checked="" type="checkbox"/> Valid Zakat & Tax Certificate			
Years of Experience (In Total): 20 YEARS				<input checked="" type="checkbox"/> Valid General Organization of Social Insurance			
Years of Experience In Saudi Arabia: 20 YEARS				<input checked="" type="checkbox"/> Valid Saudization Certificate			
				<input type="checkbox"/> Valid Contractor Classification Certificate			
				<input type="checkbox"/> Valid SASO Certificate			
				<input checked="" type="checkbox"/> Authorized Signatory of Responsible Person			
Material to Supply: WATERPROOFING, INSULATION, FIREPROOFING, CONCRETE REPAIRS, AND FLOOR COATINGS							
Approval of Supplier does not relieve contractor of his responsibilities under contract's terms.							
Contractor's Remarks: Hardcopy of company profil (3) , cd -softcopy (3)							
Contractor Incoming: Signature:  Date: 2020/08/04				Contractor Outgoing: Signature: _____ Date: _____			
Consultant Comments: MURCIA HOUSING PROJECT							
<p>SUPPLIER APPROVED TO PROVIDE THE ABOVE MENTIONED MATERIAL.</p> <p>MATERIAL TO BE PROVIDED AND AREA OF APPLICATION IS SUBJECT TO CONSULTANT APPROVAL.</p> <p>ANY MISSING CERTIFICATE, OR OUTDATED CERTIFICATE TO BE PROVIDED.</p>							
For K&A : Signature:  Date: 14/7/20							
ACTION CODE: A = Approved <input checked="" type="checkbox"/>				C = Resubmit as Noted <input type="checkbox"/>			
B = Approved as noted <input type="checkbox"/>				D = Disapproved <input type="checkbox"/>			
NOTE: The Client - National Housing Company (NHC) has the authority to approve/disapprove the supplier without any objection from _____ sides.							

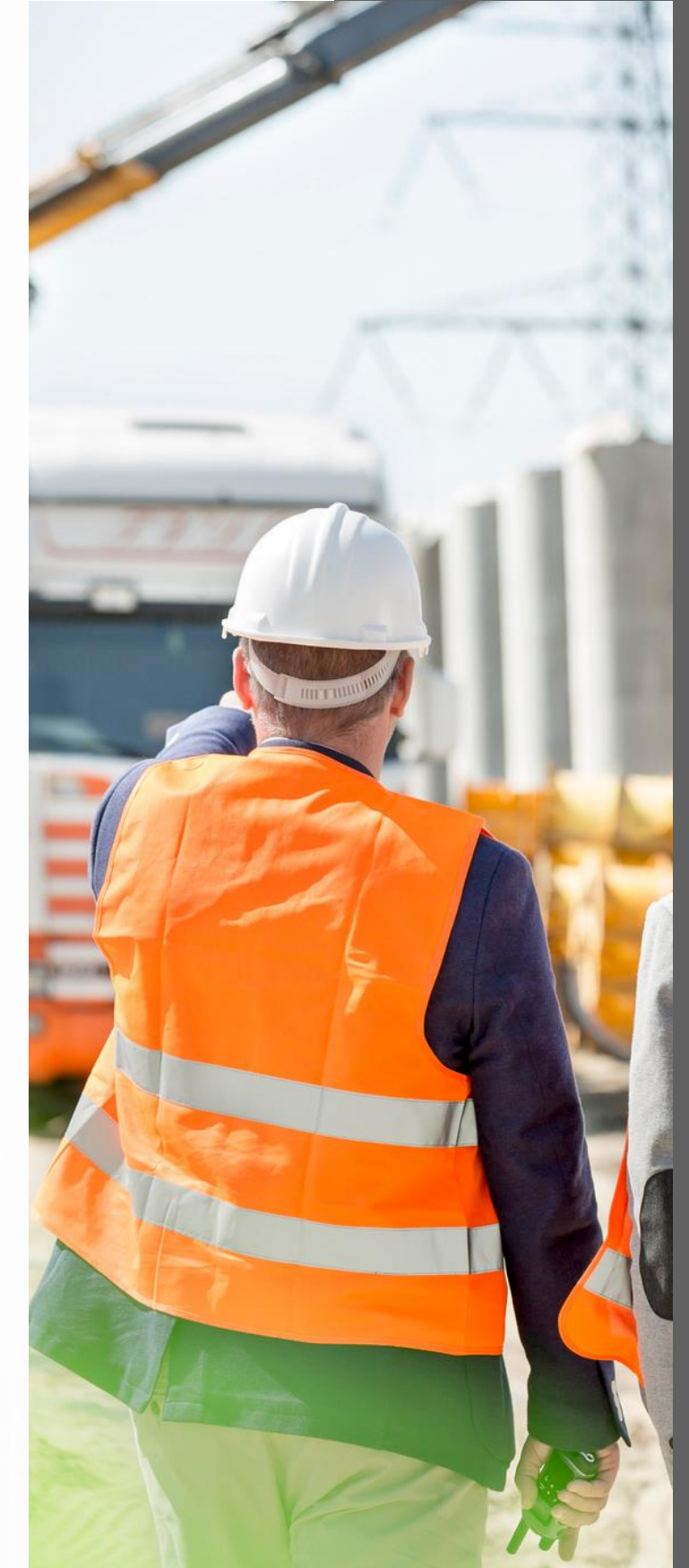

**TRANSMITTAL DETAILS**  
 Program: Y Construction Supervision  
 Project: KAFD-A1-C01-GEN-CS-TRN-00814  
 Transmittal ID: PQD-Prequalification No.0044-R1  
 Subject: PQD-Prequalification No.0044-R1 and 0052-R0 PGEN for Approval For Approval  
 Issue date: 08/09/2023  
 Response due date: 9/20/2023

**SENDER**  
 Issued by: Ahmad, Ahlaq  
 Email: aahlaq.ahmad@daralriyadh.com  
 Phone (1):  
 Phone (2):

Recipient name	Response required	Company	Recipient title	Email
Mohamed Farooq	NO	DAR-AL Riyadh	QA QC Engineer	Mohamed.Farooq@daralriyadh.com
Paul Atkinson	NO	DAR-AL Riyadh	Project Manager	Paul.Atkinson@daralriyadh.com
Abda Ikader Al-Bekour	YES	JLL	Project Manager	Abdalikader.Bekour@eu.jll.com
Ahmed Batool	YES	JLL	Project Manager	Ahmed.Batool@eu.jll.com
Brad Adams	NO	JLL	Construction Director	Brad.Adams@eu.jll.com
David Connolly	NO	JLL	Technical Director	David.Connolly@eu.jll.com
Desai Birju	NO	JLL	Sr. Planner	Birju.Desai@eu.jll.com
Fazal Reman	NO	JLL	Document Controller	Fazal.Reman@eu.jll.com
Greg Potts	NO	JLL		Greg.Potts@eu.jll.com
Ian Armstrong	YES	JLL	Project Director	Ian.Armstrong@eu.jll.com
JLL KAFD Document Control	NO	JLL	Document Control	JLLMENAKAFDDocumentControls@eu.jll.com
Mervyn Nicholl	YES	JLL	Delivery Team	Mervyn.Nicholl@eu.jll.com
Ricardo Fachin	YES	JLL	Sr. Project Manager	Ricardo.Fachin@eu.jll.com
Wilus VanZyl	YES	JLL	Associate Director	Wilus.VanZyl@eu.jll.com
Ziad Sinno	YES	JLL	Project Manager	Ziad.Sinno@eu.jll.com

**NOTES**  
 All.  
 Please find the attached PQD's No.0044-R1 and 0052-R0 for your information and approval as well.  
 Regards,  
 Ahlaq Ahmad

**ATTACHMENT**

Item no.	File name	Version	State	Description	Review Code
1	KAFD-RY-RIA1-PGEN-SAB-COM-PQD-0044-R1.pdf	R01	Published	PQD for Alkar Mamarayah Est to Cover Steel and Grating Works	
2	KAFD-RY-RIA1-PGEN-SAB-COM-PQD-0052.pdf	R00	Published	PQD for Epoxy Applicator (Gulf Crete Ltd)	B

**REFERENCES**

Item no.	File name	Version	State	Reference of
1				

**GENERAL INFORMATION**

Discipline		Document Type	Hard Copy Received
PMT	MEP	LTR	Hard Copy
PCM	ELE	DWG	Soft Copy (CD/DVD)
DCM	CON	Tech.Doc	
BSK	QMS	MOM	
COM	HSE	RPT	
ENG	SHM	WPR	
ARC	ADM	MPR	
Civil	HRM	Other	

Hard Copy Received By:  
 Name: *[Signature]*  
 Title:  
 Signature: *[Signature]*  
 08 SEP 2023  
 KAFD PROJECT

**FOR RECIPIENT/REVIEWER USE ONLY**

Review Status	Object	Document to Review
Approved-A	No Objection-D	Incomplete Document to Review
Approved with Comment-B	No Objection with Comment-E	Accepted for Construction
Objection-C	No Review Required	Accepted As-Built

Reviewer Comment:  
*Refer to OCS sheet*

Reviewed By:  
 Name: *Ziad Sinno*  
 Title: *PM*  
 Signature: *[Signature]*

Approved By:  
 Name: *[Signature]*  
 Title:  
 Signature: *[Signature]*



## APPROVED APPLICATOR CERTIFICATE

GULF CRETE CO.

This is to advise that, M/S GULF CRETE CO. has been registered as an approved applicator and the company demonstrated competence in applying the following Master Builders Solutions Saudi Arabia product/s range below:

- » Epoxy & PU Flooring Systems
- » Waterproofing system
- » Concrete Repair

This certificate has been issued upon the request of GULF CRETE CO. without having any liability on Master Builders Solutions Saudi Arabia. It is the sole responsibility of GULF CRETE CO. to strictly follow the written Method Statement, use proper tools/equipment and maintain good workmanship while applying the products.

This certificate is valid for **6 months** from this date and Master Builders Solutions Saudi Arabia reserve the right to cancel / withdraw the certificate any time if the application of the products is not in line with our written Method Statement. In the occurrence of the above, this certificate become null and void.

For and on behalf of  
 Master Builders Solutions Saudi Arabia for Manufacturing LLC

Date : 2<sup>nd</sup> April 2023  
 Ref. No. : AA/PW/075/2023

Prasad Anandu Warkar  
 Quality Manager

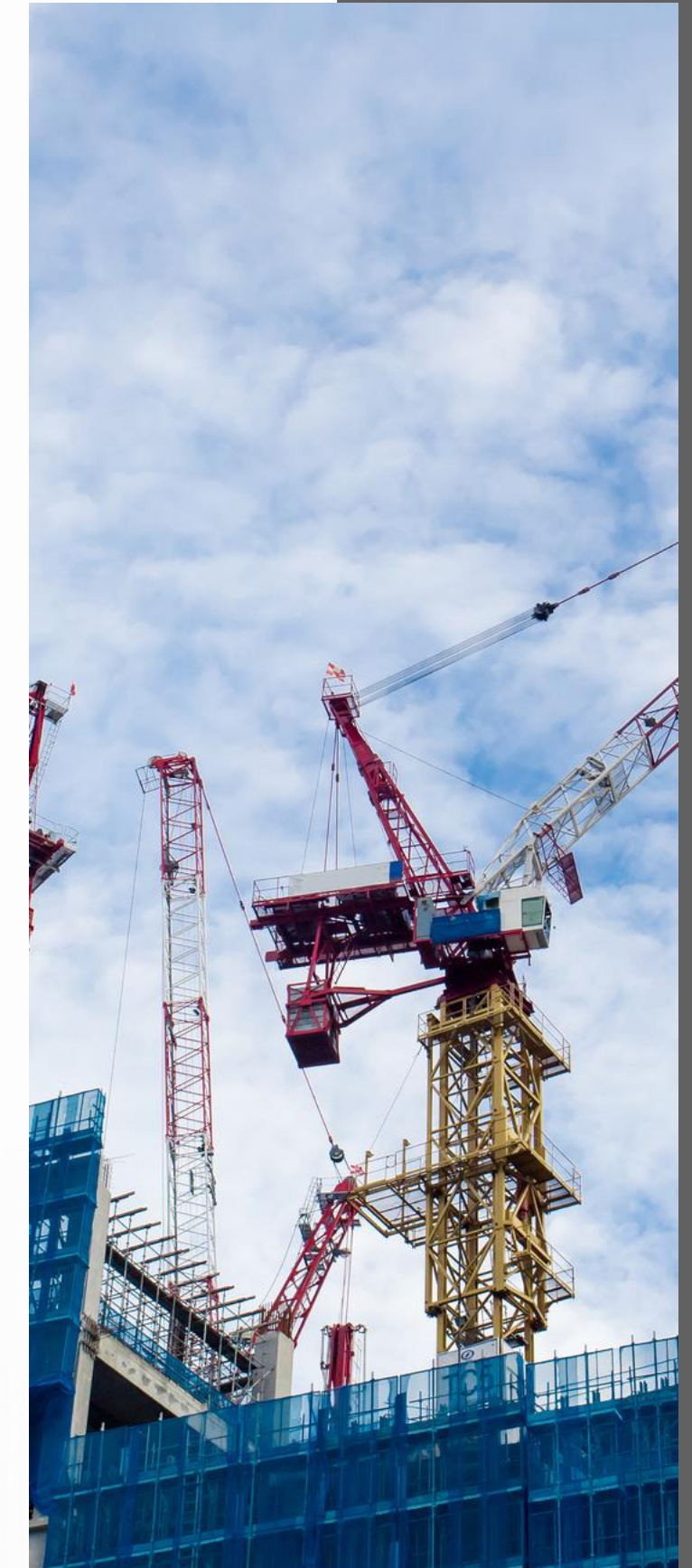





Ref : AY/06/22

Date: June 21, 2022.

**TO WHOM IT MAY CONCERN**

This is to certify that M/s. **Gulferete** have considered as our certified and approved applicator for following Fosam Products' Range as below:

- Concrete Repair.
- Protective Coatings.
- Industrial Flooring.
- Joint Sealants.

This certificate is issued upon their request without any liabilities on Fosam Company Limited and valid for six months from the date of issuance of this certificate.

Yours sincerely,  
For Fosam Company Limited



Fosam Company Limited  
Head Office  
PO Box 11061  
Jeddah - 21452  
Saudi Arabia  
C.R. No. 31273  
Paid up Capital, SR3,000,000  
[www.fosroc.com](http://www.fosroc.com)

فوسام المحدودة  
Fosam Company Limited  
مس. ب. 11061 - جدة  
C.R. No. 31273 - P.O. Box 50301 Riyadh  
ت: 482-9903 182-123

Client : National Housing Company		PMC : Dar al-handasah		Consultant : Khatib & Alami		General Contractor : Tamimi Global Company Ltd.	
<b>SUPPLIER PRE-QUALIFICATION</b>							
AR	ME	CV	LA	Submittal No.	S	P	- 1 2 4 Rev. 0 0
ST	EE	QS	OT	Date: 7/13/2020	Contract Drawing No.		
To: Khatib & Alami				From: Tamimi Global Company Ltd.			
<b>Supplier Description</b>				<b>Attachments</b>			
Name: GULF CRETE LTD THE SPECIALIZED CO.				<input checked="" type="checkbox"/> Company Profile			
Telephone No.: 0114655034				<input checked="" type="checkbox"/> Valid Commercial Registration Certificate			
Address: RIYADH-KSA				<input checked="" type="checkbox"/> Valid Membership of Chamber of Commerce			
Person in Charge and His Mobile No: 599281826				<input checked="" type="checkbox"/> Valid VAT Registration Certificate			
Supplier's Qualifying Log:				<input checked="" type="checkbox"/> Valid Zakat & Tax Certificate			
Years of Experience (In Total): 20 YEARS				<input checked="" type="checkbox"/> Valid General Organization of Social Insurance			
Years of Experience In Saudi Arabia: 20 YEARS				<input checked="" type="checkbox"/> Valid Saudization Certificate			
				<input type="checkbox"/> Valid Contractor Classification Certificate			
				<input type="checkbox"/> Valid SASO Certificate			
				<input checked="" type="checkbox"/> Authorized Signatory of Responsible Person			
<b>Material to Supply: WATERPROOFING, INSULATION, FIREPROOFING, CONCRETE REPAIRS, AND FLOOR COATINGS</b>							
Approval of Supplier does not relieve contractor of his responsibilities under contract's terms.							
Contractor's Remarks: Hardcopy of company profil (3) , cd -softcopy (3)							
Contractor Incoming: Signature:				Contractor Outgoing: Signature: _____ Date: _____			
Consultant Comments: MURCIA HOUSING PROJECT							
<p>• SUPPLIER APPROVED TO PROVIDE THE ABOVE MENTIONED MATERIAL.</p> <p>• MATERIAL TO BE PROVIDED AND AREA OF APPLICATION IS SUBJECT TO CONSULTANT APPROVAL</p> <p>• ANY MISSING CERTIFICATE, OR OUTDATED CERTIFICATE TO BE PROVIDED</p>							
For K&A : Signature:				Date: 14/7/20			
ACTION CODE: A = Approved <input type="checkbox"/> C = Resubmit as Noted <input type="checkbox"/> B = <del>Approved as noted</del> <input checked="" type="checkbox"/> D = Disapproved <input type="checkbox"/>							
NOTE: The Client - National Housing Company (NHC) has the authority to approve/disapprove the supplier without any objection from all sides.							





شركة بي إي إس إف السعودية - نواد البناء المحدودة  
 برج العثمان الطابق رقم 14  
 طريق الملك سعود، المشقة، الظهران رقم 31121  
 ص. ب. الخبر 31162 - المملكة العربية السعودية  
**Saudi BASF For Building Materials Co. Ltd.**  
 Al-Othman Business Tower 14th Floor  
 King Saud Road, Al Oshleh, Dhahran 34232  
 P.O. Box 1884, Al Khobar 31952

26<sup>th</sup> February 2017  
 Ref:/JT/L001/26022017

**PRE – QUALIFICATION CERTIFICATE OF CONFIRMITY**

This is to acknowledge that **M/S Gulf Crete Ltd. Contracting Company.** Has submitted company profile and other relevant documents to SAUDI BASF, For Building Materials Co Ltd for authorized applicator approval purpose. Hereby we are certifying that they are under review and authorized to apply our products as below.

- WATERPROOFING SYSTEMS
- Epoxy and PU flooring system
- Concrete Repair

Further to their team of supervisor had maintained good quality work. Hence, they are prequalified applicators to the Saudi BASF range of products as described above.

The pre-qualification is valid for one year from this date and subject to remain under constant monitoring for using **Saudi BASF – The Chemical Company** products. This pre-qualification can be withdrawn, if the quality of application is not to BASF's satisfaction.

For and on Behalf of  
**Saudi BASF Co.Ltd.**

*(Signature)*

**Jignesh Thakkar.**  
 Technical Manager



Head Office: المكتب الرئيسي: +966 13 853 8600, 13 812 1140  
 Tel: +966 13 832 8671, 13 812 1822  
 Fax: +966 13 832 8671, 13 812 1822  
 www.master-builders-solutions.sa  
 enquiry@saudi.basf.com



شركة ذات مسئولية محدودة في المملكة العربية السعودية رأس المال المدفوع 11 مليون ريال سجل تجاري رقم 2050037620  
 المكتب المسجل، طريق رقم 58 المنطقة الصناعية الثالثة، الدمام، المملكة العربية السعودية هاتف: +966 13 812 1140 فاكس: +966 13 812 1822  
 A private Company Incorporated with limited liability in the KSA, Paid Up Share Capital SR 11 Million, Commercial Registration No. 2050037620  
 Registered Office, Street No 58, Dammam 2nd Industrial Area, Saudi Arabia, Tel: +966 13 812 1231. Fax: +966 13 812 3269



**CERTIFICATE**  
 FOR RECOMMENDED SIKA APPLICATORS

This is to certify that

**GULF CRETE CONTRACTING**

Has successfully executed many Projects after having passed the application training of various Sika systems and is Recommended Sika Applicator for

**Concrete repair and protection, Waterproofing (PVC membranes loose laid and full compartment system), Cementitious, Resins, Combiflex range), Joint Sealants and Industrial flooring.**

This comprehensive training consisted of practical instructions about proper storage, preparation and application of Sika products.

The recommended applicator has been provided with the relevant Sika Product Data Sheets and all other technical documentation.

This confirmation is valid until the date of expiry below and may be renewed subject to the Recommended Applicator successfully completing any training courses required by Sika. The Recommended Applicator is responsible for ensuring full compliance by its employees with Sika's guidelines, training instructions and any other requirements of third parties.

Sika is not responsible for any loss or damage suffered by any third party as a result of any acts or omissions of the Recommended Applicator arising in anyway, including but not limited to breach of contract, misrepresentation, failure to comply with applicable laws or any other tort including negligence.

Sika Saudi Arabia,

Issuing Date: January 01, 2016

Expiry Date: December 31, 2016

*(Signature)*

**Shehadeh Salman**  
 T.M Waterproofing Manager  
 Central Region  
 Sika Saudi Arabia



*(Signature)*

**Emad Al Asqar**  
 Sr. Sales Manager  
 Central Region  
 Sika Saudi Arabia

This Recommendation does not assume responsibility for the correct storage, mixing or use of these Products. Sika shall not be liable for damage to persons or property, loss of business or profit or any other direct, indirect, incidental, special or consequential damage so caused by the Recommended Applicator. Sika shall also not be responsible for use of these Products in a manner that infringes on any patent or other intellectual property rights held by others. Sika's liability is limited to the quality only of the supplied material. Any failures due to wrong application or storage not in accordance with the given guidelines as stated on the label/ Technical Data Sheet, as well as structural or mechanical failures are excluded herein.



**شركة دي سي بي السعودية**

**DCP Saudi**

Date: 22<sup>nd</sup> November 2014

**TO WHOM IT MAY CONCERN**

This is to certify that **M/s Gulf Crete Ltd.** is our approved and certified applicator for all **DCP Saudi Company** Products for following ranges:

- Waterproofing system
- Joint Sealant
- Protective coating for concrete and masonry
- Epoxy Flooring
- Concrete repair
- Injection

This certificate is issued upon their request and without any liabilities on **DCP Saudi Company**, and valid for Six months from the date of issuance of this certificate.

Yours Sincerely,



For  
**DCP Saudi Co.**

**DCP Saudi**  
P.O. Box 60241 Riyadh 11576  
Kingdom of Saudi Arabia  
Tel. + 966 11 461 2003  
Fax + 966 11 279 2079  
Info.saudi@dcps-ltd.com  
www.dcp-ltd.com

Capital Paid: 1000000 S.R. CR. # 1010267930 Licence: 217074 رقم الترخيص: ٢١٧٠٧٤ رقم الشركة: ١٠١٠٢٦٧٩٣٠ ريال سعودي: ١٠٠٠٠٠٠٠ رأس المال المدفوع

expertise quality full-range



# CERTIFICATE

FOR RECOMMENDED SIKA APPLICATORS

This is to certify that

## GULF CRETE CONTRACTING

Has successfully executed many Projects after having passed the application training of various Sika systems and is Recommended Sika Applicator for

**Concrete repair and protection, Waterproofing (PVC membranes loose laid and full compartment system), Cementitious, Resins, Combiflex range), Joint Sealants and Industrial flooring.**

This comprehensive training consisted of practical instructions about proper storage, preparation and application of Sika products.

The recommended applicator has been provided with the relevant Sika Product Data Sheets and all other technical documentation.

This confirmation is valid until the date of expiry below and may be renewed subject to the Recommended Applicator successfully completing any training courses required by Sika. The Recommended Applicator is responsible for ensuring full compliance by its employees with Sika's guidelines, training instructions and any other requirements of third parties.

Sika is not responsible for any loss or damage suffered by any third party as a result of any acts or omissions of the Recommended Applicator arising in anyway, including but not limited to breach of contract, misrepresentation, failure to comply with applicable laws or any other tort including negligence.

Sika Saudi Arabia,

Issuing Date: January 01, 2016



**Shehadeh Salman**  
T.M Waterproofing Manager  
Central Region  
Sika Saudi Arabia



Expiry Date: December 31, 2016



**Emad Al Asqar**  
Sr. Sales Manager  
Central Region  
Sika Saudi Arabia

This Recommendation does not assume responsibility for the correct storage, mixing or use of these Products. Sika shall not be liable for damage to persons or property, loss of business or profit or any other direct, indirect, incidental, special or consequential damage so caused by the Recommended Applicator. Sika shall also not be responsible for use of these Products in a manner to infringe on any patent or other intellectual property rights held by others. Sika's liability is limited to the quality only of the supplied material. Any failures due to wrong application or storage not in accordance with the given guidelines as stated on the latest Technical Data Sheets, as well as structural or mechanical failures are excluded herein.

**BUILDING TRUST** 



# BASF

The Chemical Company

Saudi BASF For Building Materials Co.Ltd. PO Box 1884 Al-Khobar 31952 KSA  
 شركة ام بي سي السعودية Saudi BASF  
 شركة المواد المحدودة For Building Materials Co.Ltd.  
 بريدنا 1884 P.O Box 1884  
 الكوبر 31952 Al-Khobar 31952  
 المملكة العربية السعودية Kingdom of Saudi Arabia

18<sup>th</sup> OCTOBER 2015  
 Ref. RUH/AI/0050-15

M/s. GULF CRETE

### PRE – QUALIFICATION CERTIFICATE OF CONFORMITY

This is to certify that M/s GULF CRETE had worked with Saudi BASF range of products with the following product groups:

- Epoxy & PU Flooring systems
- Waterproofing systems
- Concrete repair

Their Team of supervisor had so far demonstrated good quality work in application and workmanship. Hence, they are granted as pre-qualified applicator for the Saudi BASF range of products as described above.

This pre-qualification is valid for one year from this date and subject to remain under constant monitoring for using Saudi BASF - The Chemical Company products. This pre-qualification can be withdrawn during the duration of this period, if the quality of application is not to BASF's Standards and Guidelines.

For and on behalf of  
 Saudi BASF Co. Ltd.  
 Technical Manager



A Private Company incorporated with limited liability in the Kingdom of Saudi Arabia  
 Paid up Share Capital SR. 5.5 Million  
 Commercial Registration No. 2050027820  
 COC Membership No. 476



Ref : KR/0513/05  
 Date : 22<sup>nd</sup> November 2014

### TO WHOM IT MAY CONCERN

This is to certify that M/s. Gulf Crete LTD. is our approved and certified applicators for all Fosam Products for the following range of applications:

- Joint sealing works.
- Specialized protective coating for concrete and masonry.
- Epoxy Flooring
- Concrete Repair

This certificate is issued upon their request and without any liabilities on Fosam Company Limited and valid for three months from the date of issuance of this certificate.

Yours sincerely,  
 For Fosam Company Limited

Kareem Rabayah  
 Area Sales Manager-Central Region  
 Mobile: 0553829272



Fosam Company Limited  
 Riyadh Office  
 PO.Box 50391  
 Riyadh - 11523  
 C.R.No. 31273  
 Paid up Capital: SR 3,000,000  
 www.fosroc.com Registered Office: Building No.153, Takasul Road, North Makkah

Telephone: 00 966 1 482 9303 Fax: 00 966 1 482 7962 E-mail: fosam\_riyadh@fosroc.com

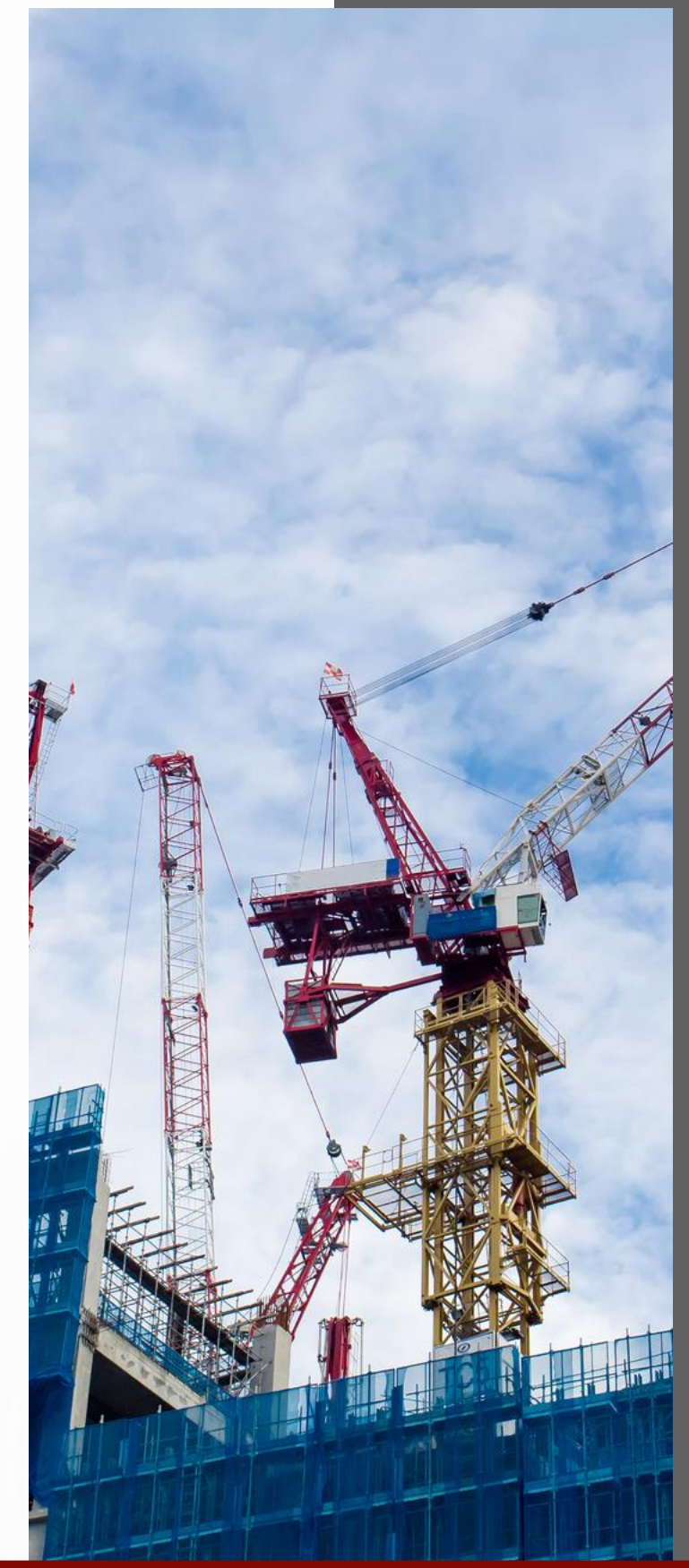

A1 -Parcel 5.04 Mixed Use (Office + Retail + Residential)  
 King Abdullah Financial District  
 King Fahd Rd 11564  
 Central Region 13519  
 Riyadh  
 Riyadh Saudi Arabia



MAIL TYPE: Workflow Transmittal  
 MAIL NUMBER: DAR-WTRAN-001464  
 REFERENCE NUMBER: DAR-WTRAN-001464

**Final (WF-000387) DAR WF (Baytur) - J01-P504-PQD-Structural Strength work for columns (Retrofitting) and repair (Gulf Crete Ltd) REV-03**

From: Mr Paul Atkinson - Dar Al Riyadh Engineering & Architecture  
 To (2): Mr Paul Atkinson - Dar Al Riyadh Engineering & Architecture (+1 more...)  
 Cc (3): Mr fazal rehman - Jones Lang Lasalle (+2 more...)  
 Sent: Wednesday, 26 May 2021 3:07:05 PM AST (GMT +03:00)  
 Status: N/A



DOCUMENT ATTACHMENTS (1)

File	Document No	Revision	Revision Date	Title	Status
	KAFD-A1-504-SAB-COM-PQD-00001	03	24/05/2021	J01-P504-PQD-Structural Strength work for columns (Retrofitting) and repair (Gulf Crete Ltd)	B - Approved with Comments

ATTRIBUTES

Attribute 1: ARC - Architect, ELE - Electrical, MEC - Mechanical, MEP - Mechanical & Electrical & Plumbing, SST - Steel Structure, STL - Structural

MESSAGE

Workflow Review History

The attached documents have completed the "DAR WF (Baytur) - J01-P504-PQD-Structural Strength work for columns (Retrofitting) and repair (Gulf Crete Ltd) REV-03" workflow with the following results :

*This transmittal was automatically generated.*

Doc No	Step	Participant	Review Outcome	Comments
KAFD-A1-504-SAB-COM-PQD-00001	PD	P Atkinson	B - Approved with Comments	No Objection, PQD only, no materials approved.

CERTIFICATION

Consultant 	Client 	Contractor 	
PROJECT NO: KSUEH-BUILDING 04		LOCATION: RIYADH-KSA	
<b>MATERIALS SUBMITTAL</b>			
SUBMITTAL NO: KSUEH-45-AR-0015		PREV. SUBMITTAL NO:	
DATE: 19 Feb-17		PREV. SUB AL DATE:	
Submittal reason: <input type="checkbox"/> INFO <input type="checkbox"/> NOTES <input checked="" type="checkbox"/> APPROVAL			
Major: <input type="checkbox"/> CV <input checked="" type="checkbox"/> AR <input type="checkbox"/> ST <input type="checkbox"/> AC <input type="checkbox"/> EL <input type="checkbox"/> PL <input type="checkbox"/> OTHER			
Attachments: <input checked="" type="checkbox"/> Brochure <input checked="" type="checkbox"/> Tech. Info <input type="checkbox"/> Sample <input checked="" type="checkbox"/> Certificate <input type="checkbox"/> Drawing <input type="checkbox"/> Calculations			
Materials/Tools			
Serial	Material Name, Number & Description	Source	Supplier / Manufacturer
1	Concrete Repair	Local	Gulf Crete LTD.
2	Protective Coating (Epoxy)		
3	Fire Proofing		
4	Water Proofing		
CONTRACTOR: Procurement Manager Name: _____ Signature: _____ Project Manager Name: Ayman Shaban Site Engr. Mohamed Zyadeh Signature: _____			
CONSULTANT NOTES: *Accepted as a subcontractor and to be provide complete information and materials details and data sheet for review and approval. #provide warranty certificate as per project specs and contract.			
CONSULTANT Name: Avazag Najjar Position: Arch Signature: _____ Date: 24/2/2017		STRATEGIC CONSTRUCTION PROGRAM Date: _____ Signature: _____ ENG. KHALID FAHD AL-SHAIDI General Manager of Strategic Construction Program	
APPROVAL SITUATION			
<input checked="" type="checkbox"/> APPROVED		<input type="checkbox"/> REJECTED	
<input type="checkbox"/> APP. WITH COMMENTS		<input type="checkbox"/> NO ACTION	
<input type="checkbox"/> APP. AS NOTED/RESUBMITTAL REQUIRED			
INCOMING SIGNATURE: _____ DATE: _____	OUTGOING SIGNATURE: _____ DATE: _____		
Consultant: Original    Contractor: Copy with Stamp    Consultant Site Office: Copy (Authority to proceed with work does not relieve the contractor from contractual responsibilities)			



**A1 - Parcel 5.04 Mixed Use (Office + Retail + Residential)**  
 King Abdullah Financial District  
 King Fahd Rd 11564  
 Central Region 13519  
 Riyadh  
 Riyadh Saudi Arabia



MAIL TYPE: Workflow Transmittal  
 MAIL NUMBER: DAR-WTRAN-001464  
 REFERENCE NUMBER: DAR-WTRAN-001464

**Final (WF-000387) DAR WF (Baytur) - J01-P504-PQD-Structural Strength work for columns (Retrofitting) and repair (Gulf Crete Ltd) REV-03**

From: Mr Paul Atkinson - Dar Al Riyadh Engineering & Architecture  
 To (2): Mr Paul Atkinson - Dar Al Riyadh Engineering & Architecture (+1 more...)  
 Cc (3): Mr fazal rehman - Jones Lang Lasalle (+2 more...)  
 Sent: Wednesday, 26 May 2021 3:07:05 PM AST (GMT +03:00)  
 Status: N/A



DOCUMENT ATTACHMENTS (1)

File	Document No	Revision	Revision Date	Title	Status
	KAFD-A1-504-SAB-COM-PQD-00001	03	24/05/2021	J01-P504-PQD-Structural Strength work for columns (Retrofitting) and repair (Gulf Crete Ltd)	B - Approved with Comments

ATTRIBUTES

Attribute 1: ARC - Architect, ELE - Electrical, MEC - Mechanical, MEP - Mechanical & Electrical & Plumbing, SST - Steel Structure, STL - Structural

MESSAGE

Workflow Review History

The attached documents have completed the "DAR WF (Baytur) - J01-P504-PQD-Structural Strength work for columns (Retrofitting) and repair (Gulf Crete Ltd) REV-03" workflow with the following results:

*This transmittal was automatically generated.*

Doc No	Step	Participant	Review Outcome	Comments
KAFD-A1-504-SAB-COM-PQD-00001	PD	P Atkinson	B - Approved with Comments	No Objection, PQD only, no materials approved.

**SUBCONTRACTOR PREQUALIFICATION SUBMITTAL FORM**

Submittal Ref.	KSP-FHJ-INW-CMT-CIV-PQD-0140	Revision	01	Date	14-Marc-2022
Program	King Salman Park				
Project	CP03 Infrastructure Works Phase 1 & O&M Center	Project No.	CP03		
Client	King Salman Park Foundation (KSPF)				
PMO	Saudi Arabian Parsons Ltd. (SAPL)	Contractor	Freyssinet-Haif JV (FHJ)		
PMC	Faithful Gould (FGS)	PMCM			

Discipline:  Civil  Architecture  Mechanical  Electrical  Information Technology  
 Landscape  Others: C

Sub-Contractor / Supplier Details	Attachments	P / x
Name: GULF CERTE – Riyadh (APPLICATOR)	Chamber of Commerce Membership.	Y
Trade: All type of Water Proofing & Thermal Insulation (APPLICATOR)	Municipality License	Y
Location: Riyadh KSA	Other Licenses (Specify):	Y
Experience (Total No. of Years): 30 Years	Please refer to PQD documents.	
Experience in KSA: 30 Years		
Contact Name: GULF CERTE Head Office Riyadh Mobile Number: 966 599281826 (Shah Rukh Ali Hassan)		
Is the company certified against any quality standard? Yes	Pre-Qualification Doc's (Specify):	Y
Is the company certified against any Health & Safety and Environment standard? Yes	Please refer to PQD documents.	
<b>Subcontractors / Supplier's Proposed Scope of Work in this project</b>		
- Waterproofing & Damp proofing – EPDM – TPO- FPO – POLYUREA - Spray Polyurethane foam Waterproofing - Geosynthetic Engineering - Concrete Repair and Protection – injection work - Building Renovations - Expansion joint – fire proof – decorative and protective epoxy coating - Stamped Concrete - Light Weight Foam Concrete		
	Completion Certificates for Previous Projects	Y

**Contractor Signatures & Stamp**

Discipline Engineer	QA/ QC	HSE	MEP	Construction Manager

Submittal Status:  
 A - Approved  B - Approved as Noted  C - Revise and Resubmit  D - Rejected

Engineer's Comments: **Complied our previous comments, contractor to keep all the documentation updated.**

PMO/Client' Comments:

Name	Signature	Date

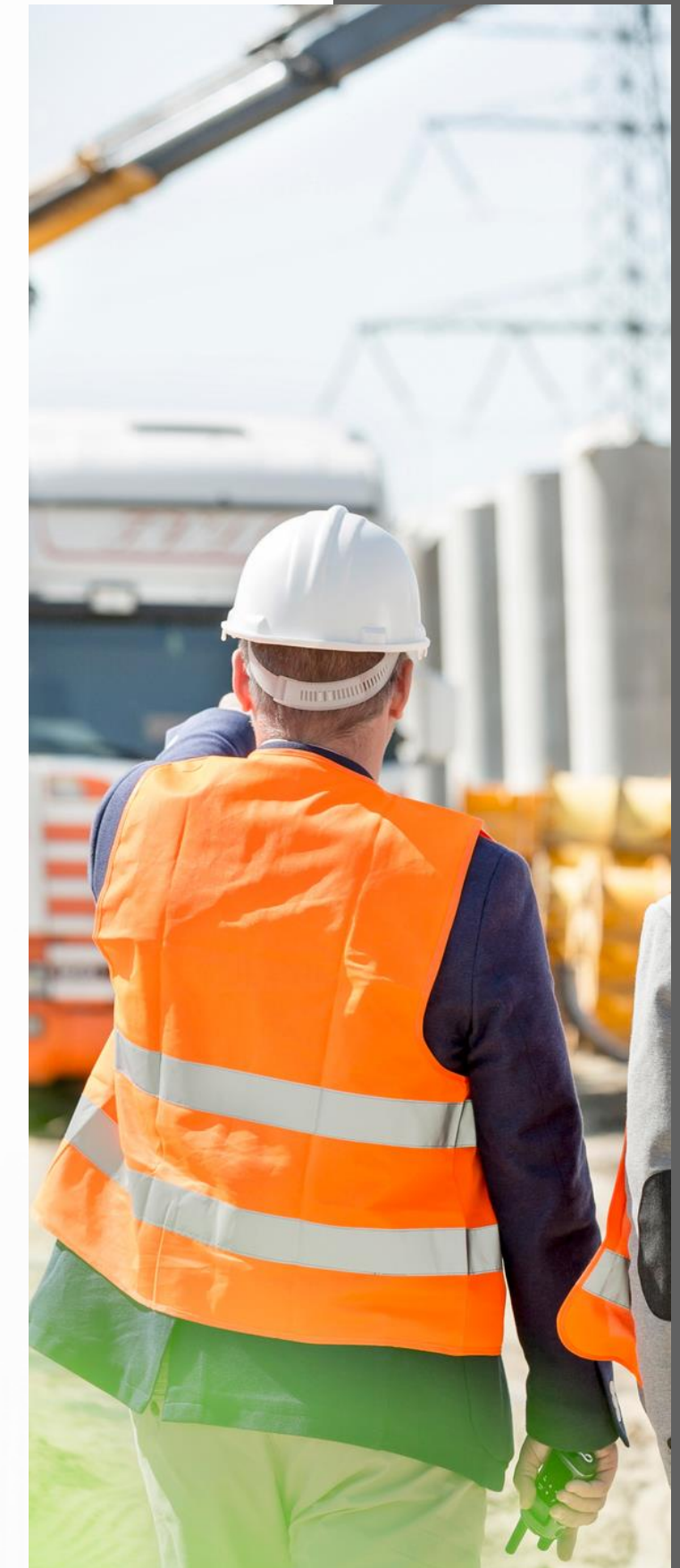

**TRANSMITTAL DETAILS**  
 Program: Y Construction Supervision  
 Project:   
 Transmittal ID: KAFD-A1-C01-GEN-CS-TRN-00814  
 Subject: PQD-Prequalification No.00044-R1 and 00052-R0 PGEN for Approval For Approval  
 Issue date: 08/09/2023  
 Response due date: 9/20/2020

**SENDER**  
 Issued by: Ahmad, Ahlaq  
 Email: aahlaq.ahmad@daralriyadh.com  
 Phone (1):  
 Phone (2):

Recipient name	Response required	Company	Recipient title	Email
Mohamed Farooq	NO	DAR-AL Riyadh	QA QC Engineer	Mohamed.Farooq@daralriyadh.com
Paul Atkinson	NO	DAR-AL Riyadh	Project Manager	Paul.Atkinson@daralriyadh.com
Abda Ikader Al-Bekour	YES	JLL	Project Manager	Abdalkader.Bekour@eu.jll.com
Ahmed Batool	YES	JLL	Project Manager	Ahmed.Batool@eu.jll.com
Brad Adams	NO	JLL	Construction Director	Brad.Adams@eu.jll.com
David Connolly	NO	JLL	Technical Director	David.Connolly@eu.jll.com
Desai Binju	NO	JLL	Sr. Planner	Binju.Desai@eu.jll.com
Fazal Roman	NO	JLL	Document Controller	Fazal.Roman@eu.jll.com
Greg Potts	NO	JLL		Greg.Potts@eu.jll.com
Ian Armstrong	YES	JLL	Project Director	Ian.Armstrong@eu.jll.com
JLL KAFD Document Control	NO	JLL	Document Control	JLLMENA-KAFD-DocumentControls@eu.jll.com
Mervyn Nicholl	YES	JLL	Delivery Team	Mervyn.Nicholl@eu.jll.com
Ricardo Fachin	YES	JLL	Sr. Project Manager	Ricardo.Fachin@eu.jll.com
Wilus VanZyl	YES	JLL	Associate Director	Wilus.VanZyl@eu.jll.com
Ziad Sinno	YES	JLL	Project Manager	Ziad.Sinno@eu.jll.com

**NOTES**  
 All  
 Please find the attached PQD's No.00044-R1 and 00052-R0 for your information and approval as well.  
 Regards,  
 Ahlaq Ahmad

**ATTACHMENT**

Item no.	File name	Version	State	Description	Review Code
1	KAFD-RY-RIA1-PGEN-SAB-COM-PQD-00044-R1.pdf	R01..	Published	PQD for Alkar Mamarayish Est to Cover Steel and Grating Works	
2	KAFD-RY-RIA1-PGEN-SAB-COM-PQD-00052.pdf	R00.	Published	PQD for Epoxy Applicator (Gulf Crete Ltd)	B

**REFERENCES**

Item no.	File name	Version	State	Reference of
1				

**GENERAL INFORMATION**

Discipline		Document Type	Hard Copy Received	
PMT	MEP	LTR	Hard Copy	
PCM	ELE	DWG	Soft Copy (CD/DVD)	
DCM	CON	Tech.Doc		
BSK	QMS	MOM		
COM	HSE	RPT		
ENG	SHM	WPR		
ARC	ADM	MPR		
Civil	HRM	Other		

Hard Copy Received By:  
 Name: *[Signature]*  
 Title: *[Signature]*  
 Signature: *[Signature]*  
 08 SEP 2023  
 KAFD PROJECT

**FOR RECIPIENT/REVIEWER USE ONLY**

Review Status	No Objection-D	Incomplete Document to Review
Approved-A	<input type="checkbox"/>	<input type="checkbox"/>
Approved with Comment-B	<input checked="" type="checkbox"/>	Accepted for Construction
Objection-C	No Objection with Comment-E	Accepted As-Built
	No Review Required	

Reviewer Comment  
*Refer to OCS sheet*

Reviewed By: *Ziad Sinno*  
 Name: *Ziad Sinno*  
 Title: *PM*  
 Signature: *[Signature]*

Approved By: *[Signature]*  
 Name:  
 Title:  
 Signature: *[Signature]*



**APPROVED APPLICATOR CERTIFICATE**

**GULF CRETE CO.**

This is to advise that, M/S GULF CRETE CO. has been registered as an approved applicator and the company demonstrated competence in applying the following Master Builders Solutions Saudi Arabia product/s range below:

- » Epoxy & PU Flooring Systems
- » Waterproofing system
- » Concrete Repair

This certificate has been issued upon the request of GULF CRETE CO. without having any liability on Master Builders Solutions Saudi Arabia. It is the sole responsibility of GULF CRETE CO. to strictly follow the written Method Statement, use proper tools/equipment and maintain good workmanship while applying the products.

This certificate is valid for **6 months** from this date and Master Builders Solutions Saudi Arabia reserve the right to cancel / withdraw the certificate any time if the application of the products is not in line with our written Method Statement. In the occurrence of the above, this certificate become null and void.

For and on behalf of  
 Master Builders Solutions Saudi Arabia for Manufacturing LLC

Date : 2<sup>nd</sup> April 2023  
 Ref. No. : AA/PW/075/2023

Prasad Anandu Warkar  
 Quality Manager

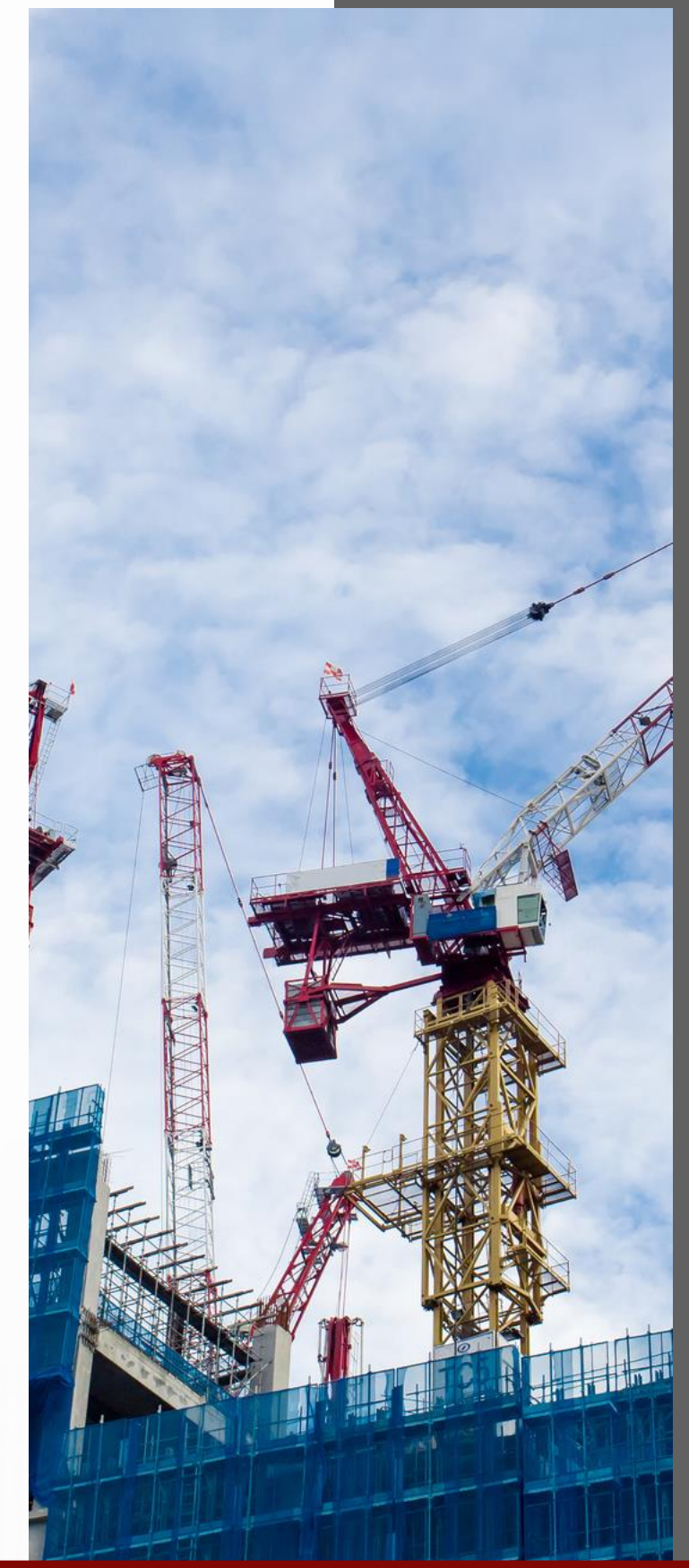

## APPROVED APPLICATOR CERTIFICATE

### GULF CRETE CO.

This is to advise that, **M/S GULF CRETE CO.** has been registered as an approved applicator and the company demonstrated competence in applying the following Master Builders Solutions Saudi Arabia product/s range below:

- » Epoxy & PU Flooring Systems
- » Waterproofing system
- » Concrete Repair

This certificate has been issued upon the request of **GULF CRETE CO.** without having any liability on Master Builders Solutions Saudi Arabia. It is the sole responsibility of **GULF CRETE CO.** to strictly follow the written Method Statement, use proper tools/equipment and maintain good workmanship while applying the products.

This certificate is valid for **6 months** from this date and Master Builders Solutions Saudi Arabia reserve the right to cancel / withdraw the certificate any time if the application of the products is not in line with our written Method Statement. In the occurrence of the above, this certificate become null and void.

For and on behalf of  
Master Builders Solutions Saudi Arabia for Manufacturing LLC

Date : 19<sup>th</sup> June 2022  
Ref. No. : AA/PW/030/2022

  
Prasad Anandu Warkar  
Quality Manager





CERTIFICATION

شركة دي سي بي السعودية



Date: 22<sup>nd</sup> November 2014

**TO WHOM IT MAY CONCERN**

This is to certify that **M/s Gulf Crete Ltd.** is our approved and certified applicator for all **DCP Saudi Company** Products for following ranges:

- Waterproofing system
- Joint Sealant
- Protective coating for concrete and masonry
- Epoxy Flooring
- Concrete repair
- Injection

This certificate is issued upon their request and without any liabilities on **DCP Saudi Company**, and valid for Six months from the date of issuance of this certificate.

Yours Sincerely,



For  
DCP Saudi Co.

**DCP Saudi**  
PO Box 60241 Riyadh 11576  
Kingdom of Saudi Arabia  
Tel : + 966 11 461 2003  
Fax : + 966 11 279 2009  
Info.saudi@dcp-int.com  
www.dcp-int.com



experience quality full-range

Capital Paid: 1000000 S.R CR. # 1010267930 Licence: 217074 رقم الترخيص: ٢١٧٠٧٤ سجل تجاري: ١٠١٠٢١٧٩٢٠ رأس المال المدفوع: ١٠٠٠٠٠٠ ريال سعودي



CERTIFICATION

# CERTIFICATE

FOR RECOMMENDED SIKA APPLICATORS

This is to certify that

**GULF CRETE CONTRACTING**

Has successfully executed many Projects after having passed the application training of various Sika systems and is Recommended Sika Applicator for

**Concrete repair and protection, Waterproofing (PVC membranes loose laid and full compartment system), Cementitious, Resins, Combiflex range), Joint Sealants and Industrial flooring.**

This comprehensive training consisted of practical instructions about proper storage, preparation and application of Sika products.

The recommended applicator has been provided with the relevant Sika Product Data Sheets and all other technical documentation.

This confirmation is valid until the date of expiry below and may be renewed subject to the Recommended Applicator successfully completing any training courses required by Sika. The Recommended Applicator is responsible for ensuring full compliance by its employees with Sika's guidelines, training instructions and any other requirements of third parties.

Sika is not responsible for any loss or damage suffered by any third party as a result of any acts or omissions of the Recommended Applicator arising in anyway, including but not limited to breach of contract, misrepresentation, failure to comply with applicable laws or any other tort including negligence.

Sika Saudi Arabia,

Issuing Date: January 01, 2016      Expiry Date: December 31, 2016



**Shehadeh Salman**  
T.M Waterproofing Manager  
Central Region  
Sika Saudi Arabia





**Emad Al Asqar**  
Sr. Sales Manager  
Central Region  
Sika Saudi Arabia

This Recommendation does not assume responsibility for the correct storage, mixing or use of these Products. Sika shall not be liable for damage to persons or property, loss of business or profit or any other direct, indirect, incidental, special or consequential damage so caused by the Recommended Applicator. Sika shall also not be responsible for use of these Products in a manner not in accordance with the given guidelines as stated on the latest Technical Data Sheet, as well as structural or mechanical failures are excluded herein.

BUILDING TRUST

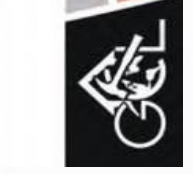





CERTIFICATION

**BASF**  
The Chemical Company

Saudi BASF For Building Materials Co. Ltd. P.O. Box 1884 Al-Khobar 31952 KSA  
شركة البترولي للمواد الإنشائية  
Saudi BASF For Building Materials Co. Ltd.  
P.O. Box 1884  
Al-Khobar 31952  
Kingdom of Saudi Arabia

18<sup>th</sup> OCTOBER 2015  
Ref. RUH/AI/0050-15

Head Office  
Tel: +966 3 8121140  
Fax: +966 3 8121822  
www.mot-saudi-arabia.com  
inquiryco.saudi@basf.com

M/s. GULF CRETE

**PRE – QUALIFICATION CERTIFICATE OF CONFORMITY**

This is to certify that M/s GULF CRETE had worked with Saudi BASF range of products with the following product groups:

- Epoxy & PU Flooring systems
- Waterproofing systems
- Concrete repair

Their Team of supervisor had so far demonstrated good quality work in application and workmanship. Hence, they are granted as pre-qualified applicator for the Saudi BASF range of products as described above.

This pre-qualification is valid for one year from this date and subject to remain under constant monitoring during using Saudi BASF - The Chemical Company products. This pre-qualification can be withdrawn during the duration of this period, if the quality of application is not to BASF's Standards and Guidelines.

For and on behalf of  
Saudi BASF Co. Ltd.

  
Technical Manager

  
Saudi BASF  
The Chemical Company

  
القسم الفني  
Technical Department

A Private Company incorporated with limited liability in the Kingdom of Saudi Arabia  
Paid Up Share Capital SR 5.5 Million  
Commercial Registration No. 2530037E2G  
COC Membership No: 476

SAGIA  
SAGIA VERITAS  
SAGIA





CERTIFICATION

**Sika Saudi Arabia Co. Ltd.**  
شركة سيكا العربية السعودية المحدودة

**CERTIFICATE**

This is to confirm that *Gulf Crete LTD Co.*  
P O Box 20647  
Riyadh 11465  
Is an approved applicator for the following applications of Sika®-Products.  
**PVC Membrane, Cementitious & Epoxy Waterproofing**

The Approved Applicator *Gulf Crete*, has received practical training in the proper storing, preparation and application of the Sika®-Products.

The approved Applicator is aware of the relevant Sika® Product Data Sheets and all other technical documentation.

This Confirmation is valid for one year from its date of issue and may be renewed subject to the Approved Applicator successfully completing any training courses required by Sika. Sika is not responsible for the Approved Applicator's compliance with Sika's guidelines or training instructions or any other requirements of third parties. Sika is not liable for any acts or omissions of the Approved Applicator arising in any way, including, but not limited to, any breach of contract, or any distort (including negligence); or any breach of statutory duty.

**THIS CERTIFICATE IS VALID FOR THE PERIOD 01/06/14 TO 01/06/2015**

Sincerely,  
  
**Emad Al Ashqar,**  
Senior Sales Manager,  
Sika Saudi Arabia,  
Riyadh,  
Mobile # 0505 363 569









**Jeddah**  
P.O. Box 112356  
Jeddah 21371  
Saudi Arabia  
Tel: +966-5-8827079  
Fax: +966-5-8821272  
C.R. No: 4002003496  
sika.jeddah@sika.com

**Dammam**  
P.O.Box 74577  
Dammam 31952  
Saudi Arabia  
Tel: +966-5-8472448  
Fax: +966-5-8471763  
sika.dammam@sika.com

**Riyadh**  
P.O.Box 58647  
Riyadh 11583  
Saudi Arabia  
Tel: +966-6-11002230  
Fax: +966-6-11002081  
sika.riyadh@sika.com

Innovation & since  
Consistency 1910

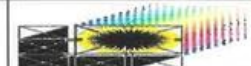

  			
Client:	PMC:	Consultant:	General Contractor:
National Housing Company	Dar al-handasah	Zuhair Fayeze	ANSAB CO.
<b>SUPPLIER PREQUALIFICATIONS &amp; MATERIAL SUBMITTAL</b>			
AR	ME	CV	LA
ST	EE	QS	OT
Date: 6/16/2022		Contract Drawing No.	
To: Zuhair Fayeze		From: ANSAB CO.	
<b>Material Details</b>		<b>List of Enclosure</b>	
Specs / BOQ / Drawings Reference	Application: MOCKUP VILLA Specification Ref.. 075552 - 072119 BOQ Reference(s): DIV - 07 Drawing Ref.:	<input checked="" type="checkbox"/>	Copy of Related Drawing
Specified Material	<b>ROOFING INSULATION SYSTEM</b>	<input checked="" type="checkbox"/>	Compliance Statement
Proposed Material	شركة أنساب للمقاولات العامة	<input checked="" type="checkbox"/>	Catalogue
Manufacturer / Local Supplier	<b>GULF CRETE LTD.</b> مشروع تطوير منطقتي 251 6/2022	<input checked="" type="checkbox"/>	Others (Specify)
Reasons for Alternative (if any)	Received	<input checked="" type="checkbox"/>	Test Certificate
Contractor's Remarks: شركة أنساب للمقاولات العامة			
Contractor Incoming Signature:	18-6-2022 8:10	Contractor Outgoing Signature:	Eng. Ahmed El... شركة تطوير منطقتي
Consultant Comments: # The submitted pre-qualification for the proposed supplier has been reviewed & found acceptable subject to client approval. # For Ms Contractor to submit compliance status & samples of materials for review & client approval. # Mock-up samples on-site to be applied after the final approval of material by client. # Method of statement (MOS) to be provided prior start mock-up on-site. 22/06 2022			
For: ZFP Signature:	Date: 23 June 2022		
<b>ACTION CODE:</b> <input checked="" type="checkbox"/> A = Approved <input type="checkbox"/> C = Resubmit as Noted <input type="checkbox"/> E = No action taken <input type="checkbox"/> B = Approved as noted <input type="checkbox"/> D = Disapproved <input type="checkbox"/> F = Retained for Info.			

CERTIFICATION



Dated: 15<sup>th</sup> June 2015

**To whom it may concern,**

This is to certify that M/S Gulf Crete is working at Centro Riyadh Hotel project under SCC supervision for water proofing & epoxy coating with the satisfaction of SCC site management.

Moreover, we are satisfied with the method of statement and standard of work done at site & comply with the specification of work.

We wish them all success in future.







Thank you and best regards,

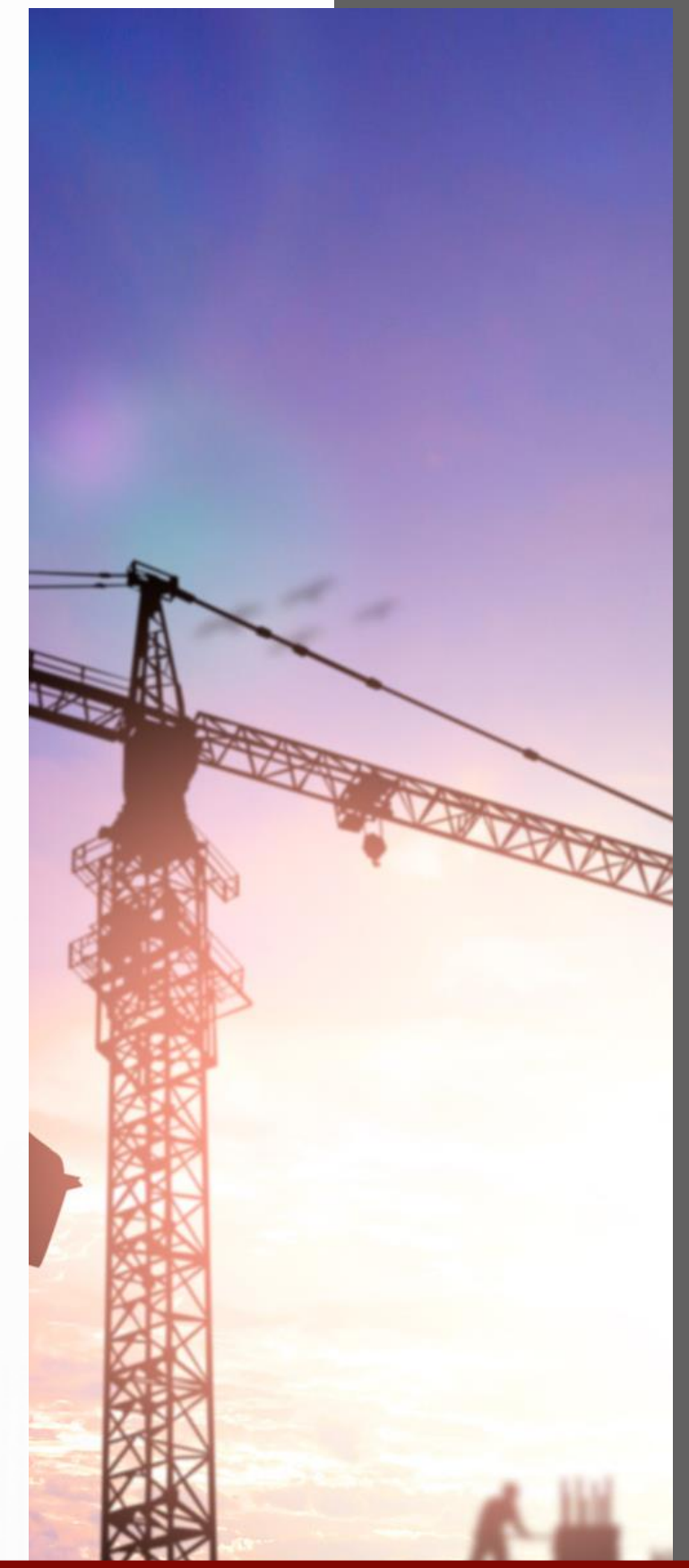

**Eng. Nicolas Haddad**  
SCC Project Manager  
Centro Riyadh Hotel project.



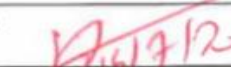

							
Client : National Housing Company		PMC : Dar al-handasah		Consultant : Khatib & Alami		General Contractor : Tamimi Global Company Ltd.	
<b>MATERIAL SUBMITTAL</b>							
AR	ME	CV	LA	Submittal No.	M	S	- 2 2 2 Rev. 0 0
ST	EE	QS	OT	Date : 7/13/2020	Contract Drawing No.		
To: Khatib & Alami				From: Tamimi Global Company Ltd.			
<b>List of Enclosure</b>							
Specs/ BOQ / Drawings Reference		Application for: Wet Areas Waterproofing System. Specification Ref. as per project specification (Sec.071416). BOQ Reference(s): MURCIA BOQ Drawing Ref:		<input type="checkbox"/>	Copy of Related Drawing		
Specified Material		Cementitious Waterproofing System.		<input checked="" type="checkbox"/>	Compliance Statement		
Proposed Material		Cementitious Waterproofing System.		<input checked="" type="checkbox"/>	Catalogue		
Manufacturer / Local Supplier		GULF CRETE LTD THE SPECIALIZED.CO( Material from BASF ).		<input checked="" type="checkbox"/>	Others (Specify)		
Reasons for Alternative (if any)				<input checked="" type="checkbox"/>	Test Certificate		
Contractor's Remarks: 							
Contractor Incoming : Signature:  Date: 2050004970		Contractor Outgoing: Signature: _____ Date: _____					
Consultant Comments: <b>MURCIA HOUSING PROJECT</b>							
<p>• MASTERTILE WP 667 IS APPROVED AS A WATERPROOF MATERIAL FOR WET AREAS ONLY.</p> <p>• MOCKUP SAMPLE WITH TEST AS PER ASTM C856 TO BE DONE PRIOR DELIVERY.</p>							
							
For K&A: Signature:  Date: 15/7/20							
<b>ACTION CODE:</b> <input type="checkbox"/> A - Approved <input checked="" type="checkbox"/> B - Approved as noted <input type="checkbox"/> C - Resubmit as Noted <input type="checkbox"/> D - Disapproved <input type="checkbox"/> E - No action taken <input type="checkbox"/> F - Retained for Info.							

							
Client : National Housing Company		PMC : Dar al-handasah		Consultant : Khatib & Alami		General Contractor : Tamimi Global Company Ltd.	
<b>MATERIAL SUBMITTAL</b>							
AR	ME	CV	LA	Submittal No.	M	S	- 2 3 0 Rev. 0 0
ST	EE	QS	OT	Date : 7/13/2020	Contract Drawing No.		
To: Khatib & Alami				From: Tamimi Global Company Ltd.			
<b>List of Enclosure</b>							
Specs/ BOQ / Drawings Reference		Application for: Wet Areas Waterproofing System. Specification Ref. as per project specification (Sec.071416). BOQ Reference(s): MURCIA BOQ Drawing Ref:		<input type="checkbox"/>	Copy of Related Drawing		
Specified Material		Cementitious Waterproofing System.		<input checked="" type="checkbox"/>	Compliance Statement		
Proposed Material		Cementitious Waterproofing System.		<input checked="" type="checkbox"/>	Catalogue		
Manufacturer / Local Supplier		GULF CRETE LTD THE SPECIALIZED.CO(Material from FOSROC)		<input checked="" type="checkbox"/>	Others (Specify)		
Reasons for Alternative (if any)				<input checked="" type="checkbox"/>	Test Certificate		
Contractor's Remarks: 							
Contractor Incoming : Signature:  Date: 2050004970		Contractor Outgoing: Signature: _____ Date: _____					
Consultant Comments: <b>MURCIA HOUSING PROJECT</b>							
<p>• NITOCOTE CM 210 IS APPROVED AS A WATERPROOF MATERIAL FOR WET AREAS ONLY.</p> <p>• MOCKUP SAMPLE WITH TEST AS PER ASTM C856 TO BE DONE PRIOR DELIVERY.</p>							
							
For K&A: Signature:  Date: 15/7/20							
<b>ACTION CODE:</b> <input type="checkbox"/> A - Approved <input checked="" type="checkbox"/> B - Approved as noted <input type="checkbox"/> C - Resubmit as Noted <input type="checkbox"/> D - Disapproved <input type="checkbox"/> E - No action taken <input type="checkbox"/> F - Retained for Info.							

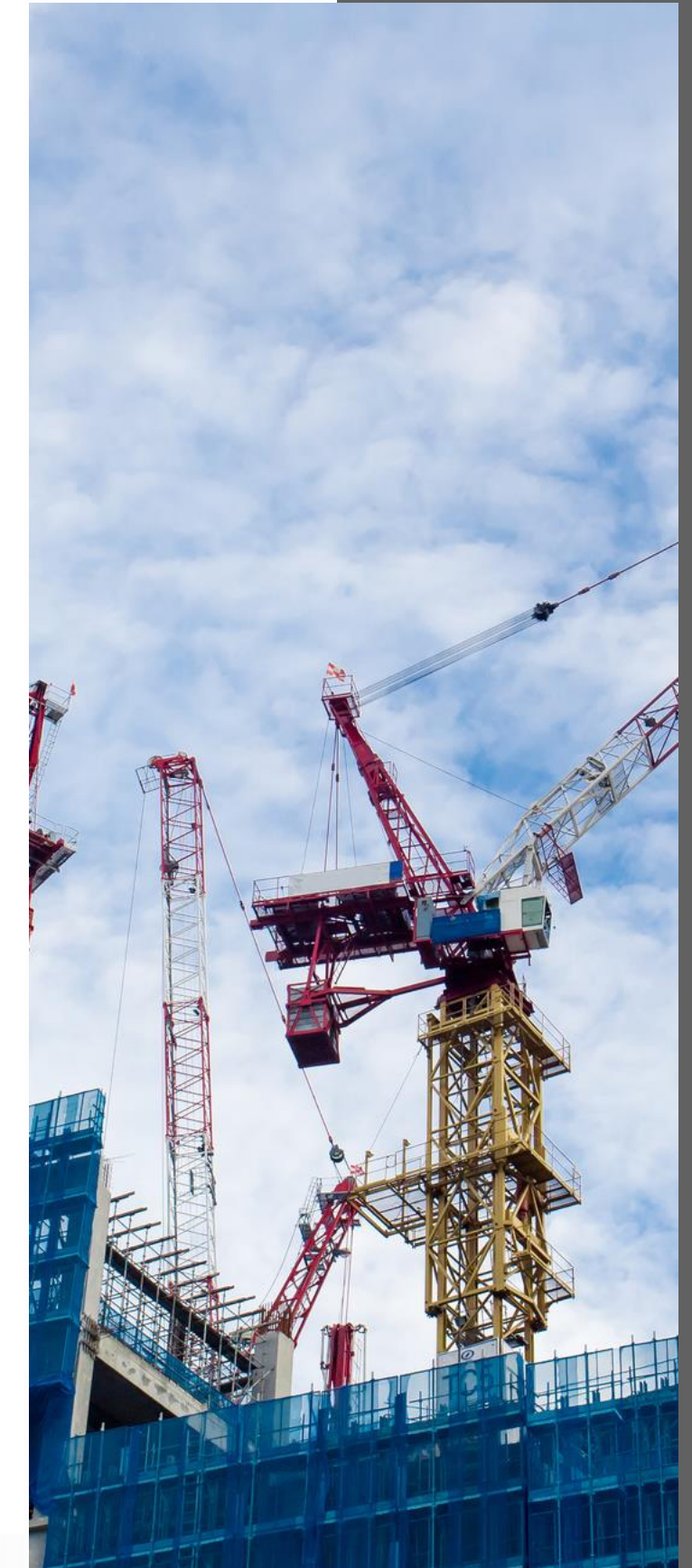

Material Submittal Form			
Submittal Ref:	NHC-KAT-PMO-MAT-CI-0081	Rev No:	00
Date:	07/07/2020		
Program Title:	Developmental Housing Project of MOH WAVE		
Project Title:	All Projects		
The Employer:	NHC		
Third party:	Saudi Arabian Parsons Ltd.-SAPL		
Consultant:	OMRAN Engineering and Consultant		
Contractor:	Kattera Saudi Arabian LLC		

**Guidance notes:**  
 The submission should only include materials which are compliant with the SOPR and CODE requirements and have been reviewed and coordinated between the Contractor and Designer (and Engineer if applicable) and should include any authorised variations/changes as instructed.

**Review Discipline**  
 Architectural  Structural/Civil  Mech/Plumb  Elec.  Others (specify

**Material Details**  
 Notes: SAPL review will recommend either Objection or No Objection to each item. Non-Objected shall be issued to the NHC with the recommendation to approve. Objected shall be returned to the Contractor with an Objection report. This sheet must be signed by any specialist sub-contractor applicable to the Material element Design/Production (e.g. Pre-cast panel manufacturer)

Proposed by	The Consultant (Designer & The Engineer)	Specialist/Sub-Contractor
Sign/Stamp	Sign/Stamp	Sign/Stamp

**Material Information & Checklist**  
 SAPL REVIEW  
 Objection  No Objection

Location /element Ref:	Specified Material:	Proposed Material:	SOPR/CODE Ref(s):	Manufacturer & Product code ref:	Remarks/Notes:
All Projects	Waterproofing	Roof Waterproofing System (Including Material Datasheet, Method statement)		Supplier: Gulf Crete Ltd.	
					Sample (available) <input checked="" type="checkbox"/> Photo Attached (Sample available in Kattera office, we will provide upon request.) <input checked="" type="checkbox"/>

THE ENGINEER*	Review date:	Approved Date:
Signed:		Print Name:
Third Party	Review date: 20-07-2020	Recommendation Date: 20-07-2020
Signed:		Print Name: Philip Doctor
The Employer	Review date:	Review Date: 23/07/2020
Signed:		Print Name: Osama Abu Nema

Client : National Housing Company	PMC : Dar al-handasah	Consultant : Khatib & Alami	General Contractor : Tamimi Global Company Ltd.
--------------------------------------	--------------------------	--------------------------------	--

**SUPPLIER PRE-QUALIFICATION**  
 AR ME CV LA Submittal No. S P - 1 2 4 Rev. 0 0  
 ST EE QS OT Date: 7/13/2020 Contract Drawing No.

Supplier Description	Attachments
Name: GULF CRETE LTD THE SPECIALIZED CO.	<input checked="" type="checkbox"/> Company Profile
Telephone No.: 0114655034	<input checked="" type="checkbox"/> Valid Commercial Registration Certificate
Address: RIYADH-KSA	<input checked="" type="checkbox"/> Valid Membership of Chamber of Commerce
Person in Charge and His Mobile No: 599281826	<input checked="" type="checkbox"/> Valid VAT Registration Certificate
Supplier's Qualifying Log:	<input checked="" type="checkbox"/> Valid Zakat & Tax Certificate
Years of Experience (In Total): 20 YEARS	<input checked="" type="checkbox"/> Valid General Organization of Social Insurance
Years of Experience In Saudi Arabia: 20 YEARS	<input checked="" type="checkbox"/> Valid Saudization Certificate
	<input type="checkbox"/> Valid Contractor Classification Certificate
	<input type="checkbox"/> Valid SASO Certificate
	<input checked="" type="checkbox"/> Authorized Signatory of Responsible Person

**Material to Supply: WATERPROOFING, INSULATION, FIREPROOFING, CONCRETE REPAIRS, AND FLOOR COATINGS**  
 Approval of Supplier does not relieve contractor of his responsibilities under contract's terms.

Contractor's Remarks: Hardcopy of company profil (3) , cd -softcopy (3)  
 Contractor Incoming: Signature: Date: 14/7/20  
 Contractor Outgoing: Signature: Date:





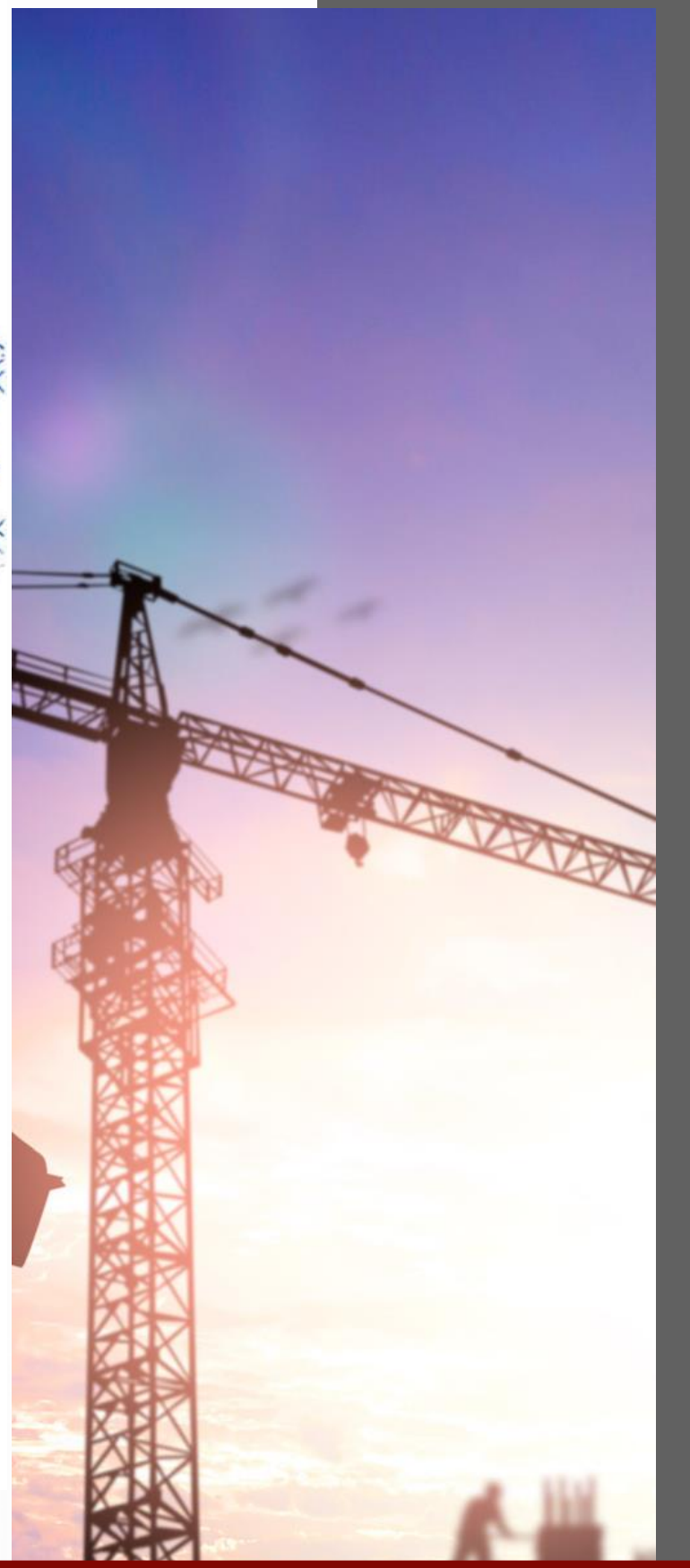

Consultant Comments:  
 - SUPPLIER APPROVED TO PROVIDE THE ABOVE MENTIONED MATERIAL.  
 - MATERIAL TO BE PROVIDED AND AREA OF APPLICATION IS SUBJECT TO CONSULTANT APPROVAL.  
 - ANY MISSING CERTIFICATE, OR OUTDATED CERTIFICATE TO BE PROVIDED

For K&A : Signature: Date: 14/7/20

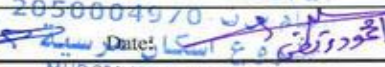

ACTION CODE:  
 A = Approved  C = Resubmit as Noted   
 B = Approved as noted  D = Disapproved

NOTE: The Client - National Housing Company (NHC) has the authority to approve/disapprove the supplier without any objection from the contractor's sides.



 Client : National Housing Company		 PMC : Dar al-handasah		 Consultant : Khatib & Alami		 General Contractor : Tamimi Global Company Ltd.	
SUPPLIER PRE-QUALIFICATION							
AR	ME	CV	LA	Submittal No.	S	P	-
ST	EE	QS	OT	Date : 7/13/2020	1	2	4
To: Khatib & Alami				From: Tamimi Global Company Ltd.			
Supplier Description				Attachments			
Name: GULF CRETE LTD THE SPECIALIZED CO.				<input checked="" type="checkbox"/> Company Profile			
Telephone No.: 0114655034				<input checked="" type="checkbox"/> Valid Commercial Registration Certificate			
Address: RIYADH-KSA				<input checked="" type="checkbox"/> Valid Membership of Chamber of Commerce			
Person in Charge and His Mobile No: 599281826				<input checked="" type="checkbox"/> Valid VAT Registration Certificate			
Supplier's Qualifying Log:				<input checked="" type="checkbox"/> Valid Zakat & Tax Certificate			
Years of Experience (In Total): 20 YEARS				<input checked="" type="checkbox"/> Valid General Organization of Social Insurance			
Years of Experience In Saudi Arabia: 20 YEARS				<input checked="" type="checkbox"/> Valid Saudization Certificate			
				<input type="checkbox"/> Valid Contractor Classification Certificate			
				<input type="checkbox"/> Valid SASO Certificate			
				<input checked="" type="checkbox"/> Authorized Signatory of Responsible Person			
Material to Supply: WATERPROOFING, INSULATION, FIREPROOFING, CONCRETE REPAIRS, AND FLOOR COATINGS							
Approval of Supplier does not relieve contractor of his responsibilities under contract's terms.							
Contractor's Remarks: Hardcopy of company profil (3) , cd -softcopy (3)							
Contractor Incoming Signature: 				Contractor Outgoing Signature: _____			
Consultant Comments: MURCIA HOUSING PROJECT							
<p><i>SUPPLIER APPROVED TO PROVIDE THE ABOVE MENTIONED MATERIAL.</i></p> <p><i>MATERIAL TO BE PROVIDED AND AREA OF APPLICATION IS SUBJECT TO CONSULTANT APPROVAL.</i></p> <p><i>ANY MISSING CERTIFICATE, OR OUTDATED CERTIFICATE TO BE PROVIDED</i></p>							
For K&A : Signature: 				Date: 14/7/20			
ACTION CODE: <input type="checkbox"/> A = Approved <input checked="" type="checkbox"/> B = Approved as noted <input type="checkbox"/> C = Resubmit as Noted <input type="checkbox"/> D = Disapproved							
NOTE: The Client - National Housing Company (NHC) has the authority to approve/disapprove the supplier without any objection from either sides.							



  			
PREQUALIFICATION APPROVAL REQUEST			
Project:	Riyadh Township - Phase 01a - (Southern)	Ref No.:	TNHP-RY-RY1-A01-RW002-SPJ-CIV-PQD-00018
Client:	ROSHN	Rev. No.:	R00
Engineer:	Akaria Hanmi for Project Management	Submittal:	Civil Date: 24-Jan-21
Contractor:	Shapoorji Pallonji Mideast (L.L.C)	Purpose/Use:	Villa
PREQUALIFICATION DESCRIPTION			
Description:	Waterproofing <input checked="" type="checkbox"/>	Company Name:	Gulf Crete Ltd for Contracting Company
Project Name.:	Riyadh Township - Phase 01a - (Southern)	Contract Ref:	RW002
Attachments:	<input checked="" type="checkbox"/> GOSI Zakat <input checked="" type="checkbox"/> Saudization Certificate <input checked="" type="checkbox"/> Ministry of Industry <input checked="" type="checkbox"/> Chamber of Commerce <input type="checkbox"/> SASO Specilized Lab Tests Certificate <input type="checkbox"/> Technical Catalog <input checked="" type="checkbox"/> Other Certificates (ISO, ....etc.) <input type="checkbox"/> Certificate of Original <input type="checkbox"/> Warranty Certificate		
MANUFACTURER DETAILS		SUPPLIER DETAILS	
Company Name:	Gulf Crete Ltd for Contracting Company	Company Name:	Gulf Crete Ltd for Contracting Company
Address:	KSA	Address:	KSA
Discipline/Trade:	Civil / CIV	Specification:	07 13 55 & 07 11 50
Project Name.:	Southern Building: Villa	BOQ Ref. No.:	-
For the Contractor:			
Name:	MURUGAN PAPAAYAN	Signature:	
Date:	24.01.2021		
ENGINEER REVIEW			
Remarks: Pre-qualification of Gulf Crete Ltd) is accepted. Material submittal required with sample & system warranty as per project requirement. For specific use only (Water proofing)			
Name:	Signature:	Date:	Consultant Stamp
Status Code: <input type="checkbox"/> Approved (A) <input checked="" type="checkbox"/> Approved with Comments (B) <input type="checkbox"/> Revise & Resubmit (C) <input type="checkbox"/> Rejected (D)			
PM (CORE TEAM) REVIEW			
All legal documents should be valid throughout the life of the project.			
Name:	MASHER UDDIN	Signature:	
Date:	25/01/2021		
CM Comments:	Remarks:	CLIENT'S APPROVAL (If Required)	<input type="checkbox"/> Yes <input type="checkbox"/> No
Name:	Signature:	Date:	Name: Signature: Date:
Approval shall not relieve the Contractor of its obligations and liabilities under the Contract or constitute authorization of any change to Contract Documents, and therefore, shall not imply on recognition whatsoever of additional time or cost to the Contract			

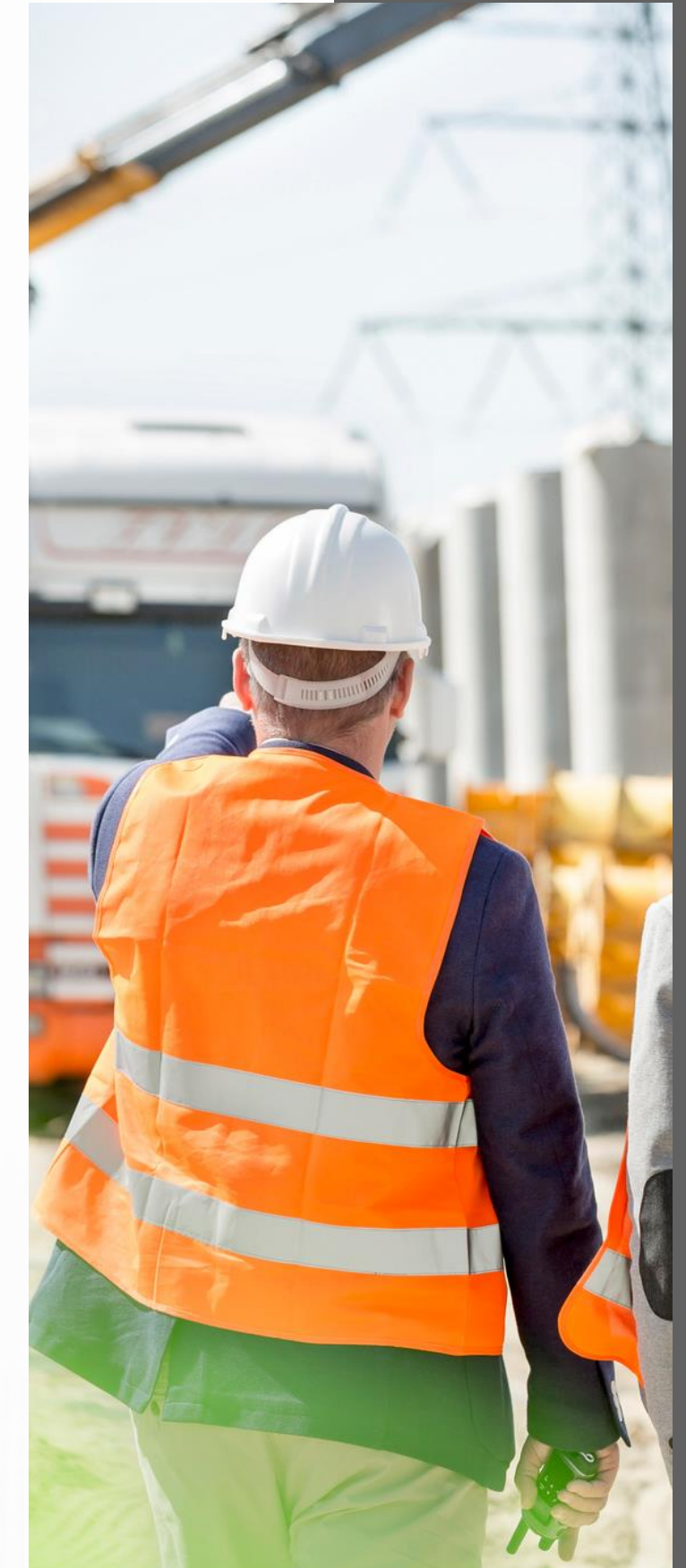



شركة المطاط الفني المحدودة  
Techno Rubber Company Limited

Date: 12/06/2022

Sub: Approved Applicator Certificate

**TO WHOMSOEVER IT MAY CONCERN**

This is to inform the concerned that **Gulf Crete Ltd.** is an approved applicator for **TECHNO RUBBER EPDM** waterproofing system. They have sufficient experience in installing **TECHNO RUBBER EPDM** waterproofing system and they are eligible for our standard roofing warranty.

For Techno Rubber Company Limited

Authorized Signatory  
Saleh Alhashem



C.R. 2050044267  
Second Industrial City  
Tel.: +966 13 8123333  
Fax: +966 13 8123322

س.ر. ٢٠٥٠٠٤٤٢٦٧  
المدينة الصناعية الثانية  
هاتف: +٩٦٦ ١٣ ٨١٢٣٣٣٣  
فاكس: +٩٦٦ ١٣ ٨١٢٣٣٢٢

Arabian Chemical Company Ltd.  
(Polystyrene)

A Joint Venture of E. A. Juffali & Brothers and The Dow Chemical Co.  
Paid-up Capital S.R 7,500,000  
C.R. No. 4030047091



الشركة العربية الكيماوية المحدودة  
(بوليستيرين)

شركة متزامنة بين شركة إبراهيم الجفالي وإخوانه وشركة داو كامييل  
مدفوع بالكامل ٧.٥٠٠.٠٠٠ ريال سعودي  
سجل تجاري رقم ٤٠٣٠٠٤٧٠٩١

Date: 13-July-2022  
Ref #: AZ/GC/136/22

**TO WHOM IT MAY CONCERN**

We, The Arabian Chemical Company (Polystyrene) Ltd - (ACC), one of EA Juffali & Brothers group of companies, do hereby certify that M/S "Gulf Crete Ltd. Co." have a good and adequate experience in installing our Insulation Products in Saudi Arabia. They are one of our approved Installing Contractors.

This Certificate does not imply any responsibility on our part for quality control of workmanship or any contractual liabilities.

Validity of this certificate till end of 2022 and is subject to ACC's regular and annual evaluation.

إلى من يهمه الأمر

تشهد الشركة العربية الكيماوية (بوليستيرين) المحدودة إحدى شركات إبراهيم الجفالي وإخوانه، بأن شركة "خليج الخرسانة المحدودة" هي شركة متخصصة و معتمدة في مجال تركيب أنظمة العزل التي تنتجها الشركة العربية الكيماوية ولديها خبرة جيدة و مناسبة لتنفيذ المشاريع داخل المملكة العربية السعودية.

أعطيت هذه الشهادة بناء على طلبهم دون أدنى مسؤولية على الشركة العربية الكيماوية المحدودة فيما يتعلق بأي أضرار مترتبة على عيوب قد تنشأ عن أخطاء في تركيب المنتجات أو خلافه.

هذه الشهادة صالحة حتى نهاية عام 2022 وتخضع للتقييم السنوي المعتاد.

Best Regards  
The Arabian Chemical Company  
(Polystyrene) Ltd

Eng. Ahmad Zimmo  
National Sales Manager



Sales Office, E.A. Juffali & Bros., Exclusive Agent for Arabian Chemical Co. Ltd.

Jeddah: P.O.Box 5728, Jeddah 21432 - Tel. (012) 667 4818 / 667 4620 - Fax (012) 660 9028  
Riyadh: P.O.Box 66, Riyadh 11411 - Tel. (011) 465 5272 / 465 5274 - Fax (011) 465 5274  
Dammam: P.O.Box 5348, Dammam 31422 - Tel. (013) 827 1652 / 827 2077 - Fax (013) 827 3623



Factory Location: Jeddah Industrial Estate (3rd Phase)



# CERTIFICATE

FOR RECOMMENDED SIKA APPLICATORS

This is to certify that

## GULF CRETE CONTRACTING

Has successfully executed many Projects after having passed the application training of various Sika systems and is Recommended Sika Applicator for

**Concrete repair and protection, Waterproofing (PVC membranes loose laid and full compartment system), Cementitious, Resins, Combiflex range), Joint Sealants and Industrial flooring.**

This comprehensive training consisted of practical instructions about proper storage, preparation and application of Sika products.

The recommended applicator has been provided with the relevant Sika Product Data Sheets and all other technical documentation.

This confirmation is valid until the date of expiry below and may be renewed subject to the Recommended Applicator successfully completing any training courses required by Sika. The Recommended Applicator is responsible for ensuring full compliance by its employees with Sika's guidelines, training instructions and any other requirements of third parties.

Sika is not responsible for any loss or damage suffered by any third party as a result of any acts or omissions of the Recommended Applicator arising in anyway, including but not limited to breach of contract, misrepresentation, failure to comply with applicable laws or any other tort including negligence.

Sika Saudi Arabia,

Issuing Date: January 01, 2016      Expiry Date: December 31, 2016



**Shehadeh Salman**  
T.M Waterproofing Manager  
Central Region  
Sika Saudi Arabia



**Emad Al Asqar**  
Sr. Sales Manager  
Central Region  
Sika Saudi Arabia

This Recommendation does not assume responsibility for the correct storage, mixing or use of these Products. Sika shall not be liable for damage to persons or property, loss of business or profit or any other direct, indirect, special or consequential damage so caused by the Recommended Applicator. Sika shall also not be responsible for use of these Products in a manner to infringe on any patent or other intellectual property rights held by others. Sika's liability is limited to the quality only of the supplied material. Any failures due to wrong application or storage not in accordance with the given guidelines as stated on the latest Technical Data Sheets, as well as structural or mechanical failures are excluded herein.



**BUILDING TRUST**





**BASF**  
We create chemistry

شركة بي إس إف السعودية - فواد البناء المحدودة  
برج العثمان الطابق رقم 14  
طريق الملك سعود، القشلة، الخبر 31332  
ص. ب. 1884 الخبر 31367 - المملكة العربية السعودية  
Saudi BASF For Building Materials Co. Ltd.  
Al-Othman Business Tower 14th Floor  
King Saud Road, Al Qashlah, Dhahran 34232  
P.O. Box 1884, Al Khobar 31362

26<sup>th</sup> February 2017  
Ref:JT/L001/26022017

### PRE – QUALIFICATION CERTIFICATE OF CONFIRMITY

This is to acknowledge that **M/S Gulf Crete Ltd. Contracting Company.** Has submitted company profile and other relevant documents to SAUDI BASF, For Building Materials Co Ltd for authorized applicator approval purpose. Hereby we are certifying that they are under review and authorized to apply our products as below.

- WATERPROOFING SYSTEMS
- Epoxy and PU flooring system
- Concrete Repair

Further to their team of supervisor had maintained good quality work. Hence, they are prequalified applicators to the Saudi BASF range of products as described above.

The pre-qualification is valid for one year from this date and subject to remain under constant monitoring for using **Saudi BASF – The Chemical Company** products. This pre-qualification can be withdrawn, if the quality of application is not to BASF's satisfaction.

For and on Behalf of  
**Saudi BASF Co.Ltd.**



**Jignesh Thakkar.**  
Technical Manager

شركة بي إس إف السعودية لمواد البناء المحدودة  
**Saudi BASF**  
for Building Mts. Co. Ltd.  
قسم المختبرات والجودة  
Technical Department

Head Office:      المكتب الرئيسي:  
Tel : +966 13 853 8600, 13 812 1140      هاتفنا: +٩٦٦ ١٣ ٨٥٣ ٨٦٠٠٠ / ١٣ ٨١٢ ١١٤٠  
Fax: +966 13 852 8671, 13 812 1822      فاكسنا: +٩٦٦ ١٣ ٨٥٢ ٨٦٧٧٢ / ١٣ ٨١٢ ١٨٢٢  
www.master-builders-solutions.sa  
enquirycc.saudi@basf.com



**MASTER®**  
**BUILDERS**  
SOLUTIONS

شركة ذات مسئولية محدودة في المملكة العربية السعودية رأس المال المدفوع 11 مليون ريال سجل تجاري رقم ٣٠٠٠٧٧٦٠  
المكتب المسجل طريق رقم ٥٨ المنطقة الصناعية الثانية، الدمام، المملكة العربية السعودية هاتفنا: +٩٦٦ ١٣ ٨١٢ ١١٤١ فاكسنا: +٩٦٦ ١٣ ٨١٢ ٢٦٦١  
A private Company Incorporated with limited liability in the KSA, Paid Up Share Capital SR 11 Million, Commercial Registration No. 2050007690  
Registered Office, Street No 58, Dammam 2nd Industrial Area, Saudi Arabia, Tel : +966 13 812 1231, Fax : +966 13 812 3269





**شركة دي سي بي السعودية**

**DCP Saudi**

Date: 22<sup>nd</sup> November 2014

**TO WHOM IT MAY CONCERN**

This is to certify that **M/s Gulf Crete Ltd.** is our approved and certified applicator for all **DCP Saudi Company** Products for following ranges:

- Waterproofing system
- Joint Sealant
- Protective coating for concrete and masonry
- Epoxy Flooring
- Concrete repair
- Injection

This certificate is issued upon their request and without any liabilities on **DCP Saudi Company**, and valid for Six months from the date of issuance of this certificate.

Yours Sincerely,



For  
DCP Saudi Co.

**DCP Saudi**  
PO Box 64241, Riyadh 11576  
Kingdom of Saudi Arabia  
Tel. + 966 11 463 2003  
Fax + 966 11 279 2009  
Info.saudi@dcp-int.com  
www.dcp-int.com

Capital Paid: 1000000 S.R CR. # 1010267930 Licence: 217074 رقم الترخيص: ٢١٧٠٧٢ ص.ت. ١٠١٠٢١٧٩٢٠ رقم المسجلة: ١٠١٠٢١٧٩٢٠

experience quality full-range



YOUR SINGLE-PLY SOLUTION™

Msg: 7024/RWA/17  
Via: Email  
Your Ref:

Our Ref:  
Date: 19-Jun-17  
No. of Pages: 1

To Whom It May Concern

Subject : Authorized Applicator Certificate  
Project : Wadi Al Hada Compound -Riyadh

This is to confirm that M/s Gulf Crete Ltd. Co., Kingdom of Saudi Arabia, based upon its experience, knowledge of product and expertise in application has met the criteria established and is hereby certified as an Authorized Applicator for Carlisle Sure-Seal, EPDM waterproofing system.

This certificate serves the above mentioned project only and it is valid for 2 (Two) years from issuing date.

Best Regards,  
Rabih Adra  
Technical Manager – Saudi Arabia

5<sup>th</sup> Floor Salsabil Building, Masmak Street, Beirut – Lebanon. Tel: +961 1 738725. Fax: +961 1 738731  
Email: [info@carlisle.com](mailto:info@carlisle.com). Web: [www.carlisle.com](http://www.carlisle.com)



شركة صناعات المواد العازلة للماء ديرمابيت المحدودة  
DWI, DERMABIT Waterproofing Industries Co. Ltd.

Fully Paid up Capital S. R. 11.5 Million  
C. R. : 1010048740

RIYADH BRANCH : P. O. BOX 5945,  
RIYADH 11432 - SAUDI ARABIA  
TEL: (011) 4645988 FAX : (011) 4634100  
Email : dermabit@dermabit.com.sa  
Website : http://www.dermabit.net

Date : 2/2/2020  
Ref.: 20/22

رأس المال المدفوع بالكامل 11,5 مليون ريال سعودي  
سجل تجاري : ١٠١٠٠٤٨٧٤٠

فرع الرياض : ص.ب ٥٩٤٥  
الرياض ١١٤٣٢ - المملكة العربية السعودية  
تلفون : ٤٦٤٥٩٨٨ (٠١١) فاكس : ٤٦٣٤١٠٠ (٠١١)  
بريد إلكتروني : dermabit@dermabit.com.sa  
الموقع الإلكتروني : http://www.dermabit.net

التاريخ : 2020/2/2 م  
الرقم : 22/20



TO WHOM IT MAY CONCERN

We, DWI, Dermabit Waterproofing Industries Co., Ltd, 100% Saudi manufacturer of waterproofing systems, do hereby certify that M/S.GULF CRETE CONTRACTING. - Riyadh, have a good and an adequate experience for a long period in installing our waterproofing products in Saudi Arabia. They are one of our approved waterproofing contractors.

This certificate does not imply any responsibility on our part for quality control of workmanship or any contractual liabilities.

Validity of this certificate is for one year from the above mentioned date and is subject to Dermabit's regular and annual evaluation.

إلى من يهمه الأمر

تشهد شركة صناعات المواد العازلة للماء ديرمابيت المحدودة شركة سعودية 100% ومنتجة لأنظمة العزل المائي البينومينية بأن شركة خليج الخرسانة ومقرها الرياض هي متخصصة ومعتمدة في مجال تركيب أنظمة العزل المائي التي تنتجها شركة ديرمابيت لفترة طويلة ولديها خبرة جيدة ومناسبة لتنفيذ المشاريع داخل المملكة العربية السعودية.

اعطيت هذه الشهادة بناء على طلبهم دون أدنى مسؤولية على شركة ديرمابيت فيما يتعلق بأي أضرار مترتبة على عيوب قد تنشأ عن أخطاء في تركيب المنتجات وخلافه.

صلاحية هذه الشهادة لمدة عام واحد من تاريخه وتخضع للتقييم السنوي المعتاد.

Best regards,

DWI, DERMABIT WATERPROOFING  
INDUSTRIES CO., LTD



MONZIR MUSHTAHA  
Regional Manager  
Central Province



المكتب الرئيسي : ص.ب ١٠٣٠٨ مدينة الجبيل الصناعية ٣١٩٦١ المملكة العربية السعودية تلفون : ٣٤١٠٤٤٤ (٠١٣) فاكس : ٣٤١٠٤٤٤ (٠١٣) ص.ب : ١٠٣٠٨  
HEAD OFFICE : P. O. BOX 10308, JUBAIL INDUSTRIAL CITY 31961 SAUDI ARABIA TEL.: (013) 3410464 FAX : (013) 3410481 C.R.: 2055001024

Arabian Waterproofing Industries Co.  
(A Saudi Joint Stock Co.)



شركة صناعات العزل العربية  
(شركة مسجلة مسجلة)

شهادة مركب معتمد

Date : 13/03/2019

\* CERTIFICATE \*

ARABIAN WATERPROOFING INDUSTRIES CO.

AWAZEL

CERTIFIES THAT :

GULF CRETE LTD.

For Construction, Maintenance Restoration Works

C.R 1010419075

P.O.BOX 285893 Riyadh 11323

Tel: 011-4655034 Fax: 011- 2939553

Is an approved applicator of our products and systems in the following fields: -

- External Waterproofing systems for underground structures including basements, tunnels, underground water tanks and swimming pools.
- Waterproofing systems for concrete roofs of public buildings and private villas.
- Waterproofing systems for metal decks of factories, warehouses and others.
- Waterproofing systems for bathrooms, kitchens and terraces.
- Joint Sealing works.
- Protective coating systems for foundations.

التاريخ : 13/03/2019 م

\* شهادة \*

شركة صناعات العزل العربية

عوازل

تشهد بأن :

شركة خليج الخرسانة

للإنشاءات والصيانة

م.ب ١٠١٠٤١٩٠٧٥ / الرياض

ص. ب 285893 الرياض 11323

هاتف / 011-4655034 فاكس / 011-2939553

مقاول معتمد تركيب مواد وأنظمة شركتنا في مجالات العمل التالية :-

- \*\* العزل المائي للإنشاءات تحت الأرض وتشمل الأقبية والأضلاع والخزانات الأرضية والمساح من الخارج.
- \*\* العزل المائي للأسطح الخرسانية للمباني العامة والفيلات.
- \*\* العزل المائي للأسطح المعدنية للمصانع والمستودعات وغيرها.
- \*\* العزل المائي لدورات المياه والمطابخ والبلكونات.
- \*\* معالجة وملء فواصل التمدد.
- \*\* الدهانات الواقية للأساسات.

\* اعطيت هذه الشهادة بناء على طلب العميل دون أدنى مسؤولية على الشركة \*

Arabian Waterproofing Industries Co.

AWAZEL

Eng. Osama Al Bani



شركة صناعات العزل العربية

عوازل

د. أوسامة الباني

شركة صناعات العزل العربية - مصنع الرياض : ص.ب ١١٤٣٢ الرياض ١١٤٣٢ المملكة العربية السعودية - مصنع جدة : ص.ب ١١٤٣٢ جدة ٢١٤٣٢ - مصنع مكة : ص.ب ٢١٤٣٢ مكة ٢١٤٣٢ - مصنع القاهرة : ص.ب ١١٤٣٢ القاهرة ١١٤٣٢ - مصنع دبي : ص.ب ١١٤٣٢ دبي ١١٤٣٢ - مصنع الكويت : ص.ب ١١٤٣٢ الكويت ١١٤٣٢ - مصنع عمان : ص.ب ١١٤٣٢ عمان ١١٤٣٢ - مصنع البحرين : ص.ب ١١٤٣٢ البحرين ١١٤٣٢ - مصنع قطر : ص.ب ١١٤٣٢ قطر ١١٤٣٢ - مصنع الإمارات : ص.ب ١١٤٣٢ الإمارات ١١٤٣٢ - مصنع السعودية : ص.ب ١١٤٣٢ السعودية ١١٤٣٢ - مصنع مصر : ص.ب ١١٤٣٢ مصر ١١٤٣٢ - مصنع ليبيا : ص.ب ١١٤٣٢ ليبيا ١١٤٣٢ - مصنع اليمن : ص.ب ١١٤٣٢ اليمن ١١٤٣٢ - مصنع العراق : ص.ب ١١٤٣٢ العراق ١١٤٣٢ - مصنع سوريا : ص.ب ١١٤٣٢ سوريا ١١٤٣٢ - مصنع الأردن : ص.ب ١١٤٣٢ الأردن ١١٤٣٢ - مصنع الكويت : ص.ب ١١٤٣٢ الكويت ١١٤٣٢ - مصنع قطر : ص.ب ١١٤٣٢ قطر ١١٤٣٢ - مصنع الإمارات : ص.ب ١١٤٣٢ الإمارات ١١٤٣٢ - مصنع السعودية : ص.ب ١١٤٣٢ السعودية ١١٤٣٢ - مصنع مصر : ص.ب ١١٤٣٢ مصر ١١٤٣٢ - مصنع ليبيا : ص.ب ١١٤٣٢ ليبيا ١١٤٣٢ - مصنع اليمن : ص.ب ١١٤٣٢ اليمن ١١٤٣٢ - مصنع العراق : ص.ب ١١٤٣٢ العراق ١١٤٣٢ - مصنع سوريا : ص.ب ١١٤٣٢ سوريا ١١٤٣٢ - مصنع الأردن : ص.ب ١١٤٣٢ الأردن ١١٤٣٢ - مصنع الكويت : ص.ب ١١٤٣٢ الكويت ١١٤٣٢ - مصنع قطر : ص.ب ١١٤٣٢ قطر ١١٤٣٢ - مصنع الإمارات : ص.ب ١١٤٣٢ الإمارات ١١٤٣٢ - مصنع السعودية : ص.ب ١١٤٣٢ السعودية ١١٤٣٢ - مصنع مصر : ص.ب ١١٤٣٢ مصر ١١٤٣٢ - مصنع ليبيا : ص.ب ١١٤٣٢ ليبيا ١١٤٣٢ - مصنع اليمن : ص.ب ١١٤٣٢ اليمن ١١٤٣٢ - مصنع العراق : ص.ب ١١٤٣٢ العراق ١١٤٣٢ - مصنع سوريا : ص.ب ١١٤٣٢ سوريا ١١٤٣٢ - مصنع الأردن : ص.ب ١١٤٣٢ الأردن ١١٤٣٢ - مصنع الكويت : ص.ب ١١٤٣٢ الكويت ١١٤٣٢ - مصنع قطر : ص.ب ١١٤٣٢ قطر ١١٤٣٢ - مصنع الإمارات : ص.ب ١١٤٣٢ الإمارات ١١٤٣٢ - مصنع السعودية : ص.ب ١١٤٣٢ السعودية ١١٤٣٢ - مصنع مصر : ص.ب ١١٤٣٢ مصر ١١٤٣٢ - مصنع ليبيا : ص.ب ١١٤٣٢ ليبيا ١١٤٣٢ - مصنع اليمن : ص.ب ١١٤٣٢ اليمن ١١٤٣٢ - مصنع العراق : ص.ب ١١٤٣٢ العراق ١١٤٣٢ - مصنع سوريا : ص.ب ١١٤٣٢ سوريا ١١٤٣٢ - مصنع الأردن : ص.ب ١١٤٣٢ الأردن ١١٤٣٢ - مصنع الكويت : ص.ب ١١٤٣٢ الكويت ١١٤٣٢ - مصنع قطر : ص.ب ١١٤٣٢ قطر ١١٤٣٢ - مصنع الإمارات : ص.ب ١١٤٣٢ الإمارات ١١٤٣٢ - مصنع السعودية : ص.ب ١١٤٣٢ السعودية ١١٤٣٢ - مصنع مصر : ص.ب ١١٤٣٢ مصر ١١٤٣٢ - مصنع ليبيا : ص.ب ١١٤٣٢ ليبيا ١١٤٣٢ - مصنع اليمن : ص.ب ١١٤٣٢ اليمن ١١٤٣٢ - مصنع العراق : ص.ب ١١٤٣٢ العراق ١١٤٣٢ - مصنع سوريا : ص.ب ١١٤٣٢ سوريا ١١٤٣٢ - مصنع الأردن : ص.ب ١١٤٣٢ الأردن ١١٤٣٢ - مصنع الكويت : ص.ب ١١٤٣٢ الكويت ١١٤٣٢ - مصنع قطر : ص.ب ١١٤٣٢ قطر ١١٤٣٢ - مصنع الإمارات : ص.ب ١١٤٣٢ الإمارات ١١٤٣٢ - مصنع السعودية : ص.ب ١١٤٣٢ السعودية ١١٤٣٢ - مصنع مصر : ص.ب ١١٤٣٢ مصر ١١٤٣٢ - مصنع ليبيا : ص.ب ١١٤٣٢ ليبيا ١١٤٣٢ - مصنع اليمن : ص.ب ١١٤٣٢ اليمن ١١٤٣٢ - مصنع العراق : ص.ب ١١٤٣٢ العراق ١١٤٣٢ - مصنع سوريا : ص.ب ١١٤٣٢ سوريا ١١٤٣٢ - مصنع الأردن : ص.ب ١١٤٣٢ الأردن ١١٤٣٢ - مصنع الكويت : ص.ب ١١٤٣٢ الكويت ١١٤٣٢ - مصنع قطر : ص.ب ١١٤٣٢ قطر ١١٤٣٢ - مصنع الإمارات : ص.ب ١١٤٣٢ الإمارات ١١٤٣٢ - مصنع السعودية : ص.ب ١١٤٣٢ السعودية ١١٤٣٢ - مصنع مصر : ص.ب ١١٤٣٢ مصر ١١٤٣٢ - مصنع ليبيا : ص.ب ١١٤٣٢ ليبيا ١١٤٣٢ - مصنع اليمن : ص.ب ١١٤٣٢ اليمن ١١٤٣٢ - مصنع العراق : ص.ب ١١٤٣٢ العراق ١١٤٣٢ - مصنع سوريا : ص.ب ١١٤٣٢ سوريا ١١٤٣٢ - مصنع الأردن : ص.ب ١١٤٣٢ الأردن ١١٤٣٢ - مصنع الكويت : ص.ب ١١٤٣٢ الكويت ١١٤٣٢ - مصنع قطر : ص.ب ١١٤٣٢ قطر ١١٤٣٢ - مصنع الإمارات : ص.ب ١١٤٣٢ الإمارات ١١٤٣٢ - مصنع السعودية : ص.ب ١١٤٣٢ السعودية ١١٤٣٢ - مصنع مصر : ص.ب ١١٤٣٢ مصر ١١٤٣٢ - مصنع ليبيا : ص.ب ١١٤٣٢ ليبيا ١١٤٣٢ - مصنع اليمن : ص.ب ١١٤٣٢ اليمن ١١٤٣٢ - مصنع العراق : ص.ب ١١٤٣٢ العراق ١١٤٣٢ - مصنع سوريا : ص.ب ١١٤٣٢ سوريا ١١٤٣٢ - مصنع الأردن : ص.ب ١١٤٣٢ الأردن ١١٤٣٢ - مصنع الكويت : ص.ب ١١٤٣٢ الكويت ١١٤٣٢ - مصنع قطر : ص.ب ١١٤٣٢ قطر ١١٤٣٢ - مصنع الإمارات : ص.ب ١١٤٣٢ الإمارات ١١٤٣٢ - مصنع السعودية : ص.ب ١١٤٣٢ السعودية ١١٤٣٢ - مصنع مصر : ص.ب ١١٤٣٢ مصر ١١٤٣٢ - مصنع ليبيا : ص.ب ١١٤٣٢ ليبيا ١١٤٣٢ - مصنع اليمن : ص.ب ١١٤٣٢ اليمن ١١٤٣٢ - مصنع العراق : ص.ب ١١٤٣٢ العراق ١١٤٣٢ - مصنع سوريا : ص.ب ١١٤٣٢ سوريا ١١٤٣٢ - مصنع الأردن : ص.ب ١١٤٣٢ الأردن ١١٤٣٢ - مصنع الكويت : ص.ب ١١٤٣٢ الكويت ١١٤٣٢ - مصنع قطر : ص.ب ١١٤٣٢ قطر ١١٤٣٢ - مصنع الإمارات : ص.ب ١١٤٣٢ الإمارات ١١٤٣٢ - مصنع السعودية : ص.ب ١١٤٣٢ السعودية ١١٤٣٢ - مصنع مصر : ص.ب ١١٤٣٢ مصر ١١٤٣٢ - مصنع ليبيا : ص.ب ١١٤٣٢ ليبيا ١١٤٣٢ - مصنع اليمن : ص.ب ١١٤٣٢ اليمن ١١٤٣٢ - مصنع العراق : ص.ب ١١٤٣٢ العراق ١١٤٣٢ - مصنع سوريا : ص.ب ١١٤٣٢ سوريا ١١٤٣٢ - مصنع الأردن : ص.ب ١١٤٣٢ الأردن ١١٤٣٢ - مصنع الكويت : ص.ب ١١٤٣٢ الكويت ١١٤٣٢ - مصنع قطر : ص.ب ١١٤٣٢ قطر ١١٤٣٢ - مصنع الإمارات : ص.ب ١١٤٣٢ الإمارات ١١٤٣٢ - مصنع السعودية : ص.ب ١١٤٣٢ السعودية ١١٤٣٢ - مصنع مصر : ص.ب ١١٤٣٢ مصر ١١٤٣٢ - مصنع ليبيا : ص.ب ١١٤٣٢ ليبيا ١١٤٣٢ - مصنع اليمن : ص.ب ١١٤٣٢ اليمن ١١٤٣٢ - مصنع العراق : ص.ب ١١٤٣٢ العراق ١١٤٣٢ - مصنع سوريا : ص.ب ١١٤٣٢ سوريا ١١٤٣٢ - مصنع الأردن : ص.ب ١١٤٣٢ الأردن ١١٤٣٢ - مصنع الكويت : ص.ب ١١٤٣٢ الكويت ١١٤٣٢ - مصنع قطر : ص.ب ١١٤٣٢ قطر ١١٤٣٢ - مصنع الإمارات : ص.ب ١١٤٣٢ الإمارات ١١٤٣٢ - مصنع السعودية : ص.ب ١١٤٣٢ السعودية ١١٤٣٢ - مصنع مصر : ص.ب ١١٤٣٢ مصر ١١٤٣٢ - مصنع ليبيا : ص.ب ١١٤٣٢ ليبيا ١١٤٣٢ - مصنع اليمن : ص.ب ١١٤٣٢ اليمن ١١٤٣٢ - مصنع العراق : ص.ب ١١٤٣٢ العراق ١١٤٣٢ - مصنع سوريا : ص.ب ١١٤٣٢ سوريا ١١٤٣٢ - مصنع الأردن : ص.ب ١١٤٣٢ الأردن ١١٤٣٢ - مصنع الكويت : ص.ب ١١٤٣٢ الكويت ١١٤٣٢ - مصنع قطر : ص.ب ١١٤٣٢ قطر ١١٤٣٢ - مصنع الإمارات : ص.ب ١١٤٣٢ الإمارات ١١٤٣٢ - مصنع السعودية : ص.ب ١١٤٣٢ السعودية ١١٤٣٢ - مصنع مصر : ص.ب ١١٤٣٢ مصر ١١٤٣٢ - مصنع ليبيا : ص.ب ١١٤٣٢ ليبيا ١١٤٣٢ - مصنع اليمن : ص.ب ١١٤٣٢ اليمن ١١٤٣٢ - مصنع العراق : ص.ب ١١٤٣٢ العراق ١١٤٣٢ - مصنع سوريا : ص.ب ١١٤٣٢ سوريا ١١٤٣٢ - مصنع الأردن : ص.ب ١١٤٣٢ الأردن ١١٤٣٢ - مصنع الكويت : ص.ب ١١٤٣٢ الكويت ١١٤٣٢ - مصنع قطر : ص.ب ١١٤٣٢ قطر ١١٤٣٢ - مصنع الإمارات : ص.ب ١١٤٣٢ الإمارات ١١٤٣٢ - مصنع السعودية : ص.ب ١١٤٣٢ السعودية ١١٤٣٢ - مصنع مصر : ص.ب ١١٤٣٢ مصر ١١٤٣٢ - مصنع ليبيا : ص.ب ١١٤٣٢ ليبيا ١١٤٣٢ - مصنع اليمن : ص.ب ١١٤٣٢ اليمن ١١٤٣٢ - مصنع العراق : ص.ب ١١٤٣٢ العراق ١١٤٣٢ - مصنع سوريا : ص.ب ١١٤٣٢ سوريا ١١٤٣٢ - مصنع الأردن : ص.ب ١١٤٣٢ الأردن ١١٤٣٢ - مصنع الكويت : ص.ب ١١٤٣٢ الكويت ١١٤٣٢ - مصنع قطر : ص.ب ١١٤٣٢ قطر ١١٤٣٢ - مصنع الإمارات : ص.ب ١١٤٣٢ الإمارات ١١٤٣٢ - مصنع السعودية : ص.ب ١١٤٣٢ السعودية ١١٤٣٢ - مصنع مصر : ص.ب ١١٤٣٢ مصر ١١٤٣٢ - مصنع ليبيا : ص.ب ١١٤٣٢ ليبيا ١١٤٣٢ - مصنع اليمن : ص.ب ١١٤٣٢ اليمن ١١٤٣٢ - مصنع العراق : ص.ب ١١٤٣٢ العراق ١١٤٣٢ - مصنع سوريا : ص.ب ١١٤٣٢ سوريا ١١٤٣٢ - مصنع الأردن : ص.ب ١١٤٣٢ الأردن ١١٤٣٢ - مصنع الكويت : ص.ب ١١٤٣٢ الكويت ١١٤٣٢ - مصنع قطر : ص.ب ١١٤٣٢ قطر ١١٤٣٢ - مصنع الإمارات : ص.ب ١١٤٣٢ الإمارات ١١٤٣٢ - مصنع السعودية : ص.ب ١١٤٣٢ السعودية ١١٤٣٢ - مصنع مصر : ص.ب ١١٤٣٢ مصر ١١٤٣٢ - مصنع ليبيا : ص.ب ١١٤٣٢ ليبيا ١١٤٣٢ - مصنع اليمن : ص.ب ١١٤٣٢ اليمن ١١٤٣٢ - مصنع العراق : ص.ب ١١٤٣٢ العراق ١١٤٣٢ - مصنع سوريا : ص.ب ١١٤٣٢ سوريا ١١٤٣٢ - مصنع الأردن : ص.ب ١١٤٣٢ الأردن ١١٤٣٢ - مصنع الكويت : ص.ب ١١٤٣٢ الكويت ١١٤٣٢ - مصنع قطر : ص.ب ١١٤٣٢ قطر ١١٤٣٢ - مصنع الإمارات : ص.ب ١١٤٣٢ الإمارات ١١٤٣٢ - مصنع السعودية : ص.ب ١١٤٣٢ السعودية ١١٤٣٢ - مصنع مصر : ص.ب ١١٤٣٢ مصر ١١٤٣٢ - مصنع ليبيا : ص.ب ١١٤٣٢ ليبيا ١١٤٣٢ - مصنع اليمن : ص.ب ١١٤٣٢ اليمن ١١٤٣٢ - مصنع العراق : ص.ب ١١٤٣٢ العراق ١١٤٣٢ - مصنع سوريا : ص.ب ١١٤٣٢ سوريا ١١٤٣٢ - مصنع الأردن : ص.ب ١١٤٣٢ الأردن ١١٤٣٢ - مصنع الكويت : ص.ب ١١٤٣٢ الكويت ١١٤٣٢ - مصنع قطر : ص.ب ١١٤٣٢ قطر ١١٤٣٢ - مصنع الإمارات : ص.ب ١١٤٣٢ الإمارات ١١٤٣٢ - مصنع السعودية : ص.ب ١١٤٣٢ السعودية ١١٤٣٢ - مصنع مصر : ص.ب ١١٤٣٢ مصر ١١٤٣٢ - مصنع ليبيا : ص.ب ١١٤٣٢ ليبيا ١١٤٣٢ - مصنع اليمن : ص.ب ١١٤٣٢ اليمن ١١٤٣٢ - مصنع العراق : ص.ب ١١٤٣٢ العراق ١١٤٣٢ - مصنع سوريا : ص.ب ١١٤٣٢ سوريا ١١٤٣٢ - مصنع الأردن : ص.ب ١١٤٣٢ الأردن ١١٤٣٢ - مصنع الكويت : ص.ب ١١٤٣٢ الكويت ١١٤٣٢ - مصنع قطر : ص.ب ١١٤٣٢ قطر ١١٤٣٢ - مصنع الإمارات : ص.ب ١١٤٣٢ الإمارات ١١٤٣٢ - مصنع السعودية : ص.ب ١١٤٣٢ السعودية ١١٤٣٢ - مصنع مصر : ص.ب ١١٤٣٢ مصر ١١٤٣٢ - مصنع ليبيا : ص.ب ١١٤٣٢ ليبيا ١١٤٣٢ - مصنع اليمن : ص.ب ١١٤٣٢ اليمن ١١٤٣٢ - مصنع العراق : ص.ب ١١٤٣٢ العراق ١١٤٣٢ - مصنع سوريا : ص.ب ١١٤٣٢ سوريا ١١٤٣٢ - مصنع الأردن : ص.ب ١١٤٣٢ الأردن ١١٤٣٢ - مصنع الكويت : ص.ب ١١٤٣٢ الكويت ١١٤٣٢ - مصنع قطر : ص.ب ١١٤٣٢ قطر ١١٤٣٢ - مصنع الإمارات : ص.ب ١١٤٣٢ الإمارات ١١٤٣٢ - مصنع السعودية : ص.ب ١١٤٣٢ السعودية ١١٤٣٢ - مصنع مصر : ص.ب ١١٤٣٢ مصر ١١٤٣٢ - مصنع ليبيا : ص.ب ١١٤٣٢ ليبيا ١١٤٣٢ - مصنع اليمن : ص.ب ١١٤٣٢ اليمن ١١٤٣٢ - مصنع العراق : ص.ب ١١٤٣٢ العراق ١١٤٣٢ - مصنع سوريا : ص.ب ١١٤٣٢ سوريا ١١٤٣٢ - مصنع الأردن : ص.ب ١١٤٣٢ الأردن ١١٤٣٢ - مصنع الكويت : ص.ب ١١٤٣٢ الكويت ١١٤٣٢ - مصنع قطر : ص.ب ١١٤٣٢ قطر ١١٤٣٢ - مصنع الإمارات : ص.ب ١١٤٣٢ الإمارات ١١٤٣٢ - مصنع السعودية : ص.ب ١١٤٣٢ السعودية ١١٤٣٢ - مصنع مصر : ص.ب ١١٤٣٢ مصر ١١٤٣٢ - مصنع ليبيا : ص.ب ١١٤٣٢ ليبيا ١١٤٣٢ - مصنع اليمن : ص.ب ١١٤٣٢ اليمن ١١٤٣٢ - مصنع العراق : ص.ب ١١٤٣٢ العراق ١١٤٣٢ - مصنع سوريا : ص.ب ١١٤٣٢ سوريا ١١٤٣٢ - مصنع الأردن : ص.ب ١١٤٣٢ الأردن ١١٤٣٢ - مصنع الكويت : ص.ب ١١٤٣٢ الكويت ١١٤٣٢ - مصنع قطر : ص.ب ١١٤٣٢ قطر ١١٤٣٢ - مصنع الإمارات : ص.ب ١١٤٣٢ الإمارات ١١٤٣٢ - مصنع السعودية : ص.ب ١١٤٣٢ السعودية ١١٤٣٢ - مصنع مصر : ص.ب ١١٤٣٢ مصر ١١٤٣٢ - مصنع ليبيا : ص.ب ١١٤٣٢ ليبيا ١١٤٣٢ - مصنع اليمن : ص.ب ١١٤٣٢ اليمن ١١٤٣٢ - مصنع العراق : ص.ب ١١٤٣٢ العراق ١١٤٣٢ - مصنع سوريا : ص.ب ١١٤٣٢ سوريا ١١٤٣٢ - مصنع الأردن : ص.ب ١١٤٣٢ الأردن ١١٤٣٢ - مصنع الكويت : ص.ب ١١٤٣٢ الكويت ١١٤٣٢ - مصنع قطر : ص.ب ١١٤٣٢ قطر ١١٤٣٢ - مصنع الإمارات : ص.ب ١١٤٣٢ الإمارات ١١٤٣٢ - مصنع السعودية : ص.ب ١١٤٣٢ السعودية ١١٤٣٢ - مصنع مصر : ص.ب ١١٤٣٢ مصر ١١٤٣٢ - مصنع ليبيا : ص.ب ١١٤٣٢ ليبيا ١١٤٣٢ - مصنع اليمن : ص.ب ١١٤٣٢ اليمن ١١٤٣٢ - مصنع العراق : ص.ب ١١٤٣٢ العراق ١١٤٣٢ - مصنع سوريا : ص.ب ١١٤٣٢ سوريا ١١٤٣٢ - مصنع الأردن : ص.ب ١١٤٣٢ الأردن ١١٤٣٢ - مصنع الكويت : ص.ب ١١٤٣٢ الكويت ١١٤٣٢ - مصنع قطر : ص.ب ١١٤٣٢ قطر ١١٤٣٢ - مصنع الإمارات : ص.ب ١١٤٣٢ الإمارات ١١٤٣٢ - مصنع السعودية : ص.ب ١١٤٣٢ السعودية ١١٤٣٢ - مصنع مصر : ص.ب ١١٤٣٢ مصر ١١٤٣٢ - مصنع ليبيا : ص.ب ١١٤٣٢ ليبيا ١١٤٣٢ - مصنع اليمن : ص.ب ١١٤٣٢ اليمن ١١٤٣٢ - مصنع العراق : ص.ب ١١٤٣٢ العراق ١١٤٣٢ - مصنع سوريا : ص.ب ١١٤٣٢ سوريا ١١٤٣٢ - مصنع الأردن : ص.ب ١١٤٣٢ الأردن ١١٤٣٢ - مصنع الكويت : ص.ب ١١٤٣٢ الكويت ١١٤٣٢ - مصنع قطر : ص.ب ١١٤٣٢ قطر ١١٤٣٢ - مصنع الإمارات : ص.ب ١١٤٣٢ الإمارات ١١٤٣٢ - مصنع السعودية : ص.ب ١١٤٣٢ السعودية ١١٤٣٢ - مصنع مصر : ص.ب ١١٤٣٢ مصر ١١٤٣٢ - مصنع ليبيا : ص.ب ١١٤٣٢ ليبيا ١١٤٣٢ - مصنع اليمن : ص.ب ١١٤٣٢ اليمن ١١٤٣٢ - مصنع العراق : ص.ب ١١٤٣٢ العراق ١١٤٣٢ - مصنع سوريا : ص.ب ١١٤٣٢ سوريا ١١٤٣٢ - مصنع الأردن : ص.ب ١١٤٣٢ الأردن ١١٤٣٢ - مصنع الكويت : ص.ب ١١٤٣٢ الكويت ١١٤٣٢ - مصنع قطر : ص.ب ١١٤٣٢ قطر ١١٤٣٢ - مصنع الإمارات : ص.ب ١١٤٣٢ الإمارات ١١٤٣٢ - مصنع السعودية : ص.ب ١١٤٣٢ السعودية ١١٤٣٢ - مصنع مصر : ص.ب ١١٤٣٢ مصر ١١٤٣٢ - مصنع ليبيا : ص.ب ١١٤٣٢ ليبيا ١١٤٣٢ - مصنع اليمن : ص.ب ١١٤٣٢ اليمن ١١٤٣٢ - مصنع العراق : ص.ب ١١٤٣٢ العراق ١١٤٣٢ - مصنع سوريا : ص.ب ١١٤٣٢ سوريا ١١٤٣٢ - مصنع الأردن : ص.ب ١١٤٣٢ الأردن ١١٤٣٢ - مصنع الكويت : ص.ب ١١٤٣٢ الكويت ١١٤٣٢ - مصنع قطر : ص.ب ١١٤٣٢ قطر ١١٤٣٢ - مصنع الإمارات : ص.ب ١١٤٣٢ الإمارات ١١٤٣٢ - مصنع السعودية : ص.ب ١١٤٣٢ السعودية ١١٤٣٢ - مصنع مصر : ص.ب ١١٤٣٢ مصر ١١٤٣٢ - مصنع ليبيا : ص.ب ١١٤٣٢ ليبيا ١١٤٣٢ - مصنع اليمن : ص.ب ١١٤٣٢ اليمن ١١٤٣٢ - مصنع العراق : ص.ب ١١٤٣٢ العراق ١١٤٣٢ - مصنع سوريا : ص.ب ١١٤٣٢ سوريا ١١٤٣٢ - مصنع الأردن : ص.ب ١١٤٣٢ الأردن ١١٤٣٢ - مصنع الكويت : ص.ب ١١٤٣٢ الكويت ١١٤٣٢ - مصنع قطر : ص.ب ١١٤٣٢ قطر ١١٤٣٢ - مصنع الإمارات : ص.ب ١١٤٣٢ الإمارات ١١٤٣٢ - مصنع السعودية : ص.ب ١١٤٣٢ السعودية ١١٤٣٢ - مصنع مصر : ص.ب ١١٤٣٢ مصر ١١٤٣٢ - مصنع ليبيا : ص.ب ١١٤٣٢ ليبيا ١١٤٣٢ - مصنع اليمن : ص.ب ١١٤٣٢ اليمن ١١٤٣٢ - مصنع العراق : ص.ب ١١٤٣٢ العراق ١١٤٣٢ - مصنع سوريا : ص.ب ١١٤٣٢ سوريا ١١٤٣٢ - مصنع الأردن : ص.ب ١١٤٣٢ الأردن ١١٤٣٢ - مصنع الكويت : ص.ب ١١٤٣٢ الكويت ١١٤٣٢ - مصنع قطر : ص.ب ١١٤٣٢ قطر ١١٤٣٢ - مصنع الإمارات : ص.ب ١١٤٣٢ الإمارات

Consultant Strategic Construction Program	Client Kansafkanh Arab	Contractor Sharqawi E/M Qistuf Al Jazeera																																				
PROJECT NO: PROJECT NAME	LOCATION: RIYADH- KSA KSUEH- BUILDING 04																																					
<b>MATERIALS SUBMITTAL</b>																																						
SUBMITTAL NO: KSUEH45-AR-0015    PREV. SUBMITTAL NO:																																						
DATE: 19-Feb-17    PREV. SUB. AL DATE:																																						
Submittal reason: <input type="checkbox"/> INFO <input type="checkbox"/> NOTES <input checked="" type="checkbox"/> APPROVAL																																						
Major: <input type="checkbox"/> CV <input checked="" type="checkbox"/> AR <input type="checkbox"/> ST <input type="checkbox"/> AC <input type="checkbox"/> EL <input type="checkbox"/> PL <input type="checkbox"/> OTHER																																						
Attachments: <input checked="" type="checkbox"/> Brochure <input checked="" type="checkbox"/> Tech. Info <input type="checkbox"/> Sample <input checked="" type="checkbox"/> Certificate <input type="checkbox"/> Drawing <input type="checkbox"/> Calculations																																						
Materials/Tools																																						
Serial	Material Name, Number & Description	Source																																				
1	Concrete Repairs	Local Gulf Crete LTD.																																				
2	Protective Coating (Epoxy)																																					
3	Fire Proofing																																					
4	Water Proofing																																					
<table border="1"> <tr> <td>CONTRACTOR</td> <td>Project Manager</td> </tr> <tr> <td>Procurement Manager</td> <td>Name: Aymen Shaban    Site Engr. Muhamed Zyadeh</td> </tr> <tr> <td>Name:</td> <td>Signature:</td> </tr> <tr> <td colspan="2">CONSULTANT NOTES</td> </tr> <tr> <td colspan="2">*Accepted as a subcontractor and to be provide complete information and materials details and data sheet for review and approval.</td> </tr> <tr> <td colspan="2">*provide warranty certificate as per project specs and contract.</td> </tr> <tr> <td colspan="2">CONSULTANT</td> </tr> <tr> <td>Name: Avazag Najjar</td> <td>Date:</td> </tr> <tr> <td>Position: Arch</td> <td>Signature:</td> </tr> <tr> <td>Signature:</td> <td>ENG. KHALID FAHD AL-SHAIDDI</td> </tr> <tr> <td>Date: 2/12/2017</td> <td>General Manager of Strategic Construction Program</td> </tr> <tr> <td colspan="2">APPROVAL SITUATION</td> </tr> <tr> <td><input checked="" type="checkbox"/> APPROVED</td> <td><input type="checkbox"/> REJECTED</td> </tr> <tr> <td><input type="checkbox"/> APP. WITH COMMENTS</td> <td><input type="checkbox"/> NO ACTION</td> </tr> <tr> <td><input type="checkbox"/> APP. AS NOTED (RESUBMITTAL REQUIRED)</td> <td></td> </tr> <tr> <td>INCOMING SIGNATURE:</td> <td>OUTGOING SIGNATURE:</td> </tr> <tr> <td>DATE:</td> <td>DATE:</td> </tr> <tr> <td colspan="2">                 Consultant: Original    Contractor: Copy with Stamp    Consultant Site Office: Copy                  (Authority to proceed with work does not relieve the contractor from contractual responsibilities)             </td> </tr> </table>			CONTRACTOR	Project Manager	Procurement Manager	Name: Aymen Shaban    Site Engr. Muhamed Zyadeh	Name:	Signature:	CONSULTANT NOTES		*Accepted as a subcontractor and to be provide complete information and materials details and data sheet for review and approval.		*provide warranty certificate as per project specs and contract.		CONSULTANT		Name: Avazag Najjar	Date:	Position: Arch	Signature:	Signature:	ENG. KHALID FAHD AL-SHAIDDI	Date: 2/12/2017	General Manager of Strategic Construction Program	APPROVAL SITUATION		<input checked="" type="checkbox"/> APPROVED	<input type="checkbox"/> REJECTED	<input type="checkbox"/> APP. WITH COMMENTS	<input type="checkbox"/> NO ACTION	<input type="checkbox"/> APP. AS NOTED (RESUBMITTAL REQUIRED)		INCOMING SIGNATURE:	OUTGOING SIGNATURE:	DATE:	DATE:	Consultant: Original    Contractor: Copy with Stamp    Consultant Site Office: Copy (Authority to proceed with work does not relieve the contractor from contractual responsibilities)	
CONTRACTOR	Project Manager																																					
Procurement Manager	Name: Aymen Shaban    Site Engr. Muhamed Zyadeh																																					
Name:	Signature:																																					
CONSULTANT NOTES																																						
*Accepted as a subcontractor and to be provide complete information and materials details and data sheet for review and approval.																																						
*provide warranty certificate as per project specs and contract.																																						
CONSULTANT																																						
Name: Avazag Najjar	Date:																																					
Position: Arch	Signature:																																					
Signature:	ENG. KHALID FAHD AL-SHAIDDI																																					
Date: 2/12/2017	General Manager of Strategic Construction Program																																					
APPROVAL SITUATION																																						
<input checked="" type="checkbox"/> APPROVED	<input type="checkbox"/> REJECTED																																					
<input type="checkbox"/> APP. WITH COMMENTS	<input type="checkbox"/> NO ACTION																																					
<input type="checkbox"/> APP. AS NOTED (RESUBMITTAL REQUIRED)																																						
INCOMING SIGNATURE:	OUTGOING SIGNATURE:																																					
DATE:	DATE:																																					
Consultant: Original    Contractor: Copy with Stamp    Consultant Site Office: Copy (Authority to proceed with work does not relieve the contractor from contractual responsibilities)																																						



بسم الله الرحمن الرحيم

شركة الشرق للإنشاءات - ويفرز المحدودة - قرية مسودة السابعة - رأس النور - الرياض 11563

**W** Orient Construction Company Ltd. **WEAVERS** - 11563 RIYADH - KSA

الخرج  
17/06/15

الى من يهيمه الامر

بهذا تشهد شركة الشرق للإنشاءات- ويفرز المحدودة بان شركة خليج الخرسانة قد قامت بتنفيذ مشروع " اعمال العزل المائي لمشروع CPP3 المراعي بمدينة الخرج كما يشهد المجلس بان شركة خليج الخرسانة قد أوفت بكافة التزاماتها. وقد أعطيت هذه الشهادة لشركة خليج الخرسانة كشهادة انجاز لأعمال المشروع بنجاح.

شركة الشرق للإنشاءات و يفرز المحدودة

*(Handwritten signature)*

الرياض نمرة 11-11111111 - صرب 11742 - هاتفنا 113881  
 جدة نمرة 11-11111111 - صرب 11113 - هاتفنا 11113  
 JEDDAH: C.R. 403004287 JCC : 19756 - P.O.Box 11163 Jeddah 21463  
 Riyadh: C.R. 101902539 - P.O.Box 41384 - Tel: 4780571  
 هاتفنا 11742 / 11111111 - فاكس 11742 - وفيرز - فاكس: 11742  
 Tel: 051 774145, 053 2852 - Tele: 00504 WEAVER SA- Fax: 051 2884



**SUBCONTRACTOR PREQUALIFICATION SUBMITTAL FORM**

Submittal Ref.	KSP-FHJ-INW-CMT-CIV-PQD-0140	Revision	01	Date	14-Marc-2022
Program	King Salman Park				
Project	CP03 Infrastructure Works Phase 1 & O&M Center	Project No.	CP03		
Client	King Salman Park Foundation (KSPF)				
PMO	Saudi Arabian Parsons Ltd. (SAPL)	Contractor	Freyssinet-Haif JV (FHJ)		
PMC	Faithful Gould (FGS)	PMCM			

**Discipline**   
 Civil   
 Architecture   
 Mechanical   
 Electrical   
 Information Technology  
 Landscape   
 Others: C

Sub-Contractor / Supplier Details	Attachments	P / x
Name: GULF CERTE – Riyadh (APPLICATOR)	Chamber of Commerce Membership.	Y
Trade: All type of Water Proofing & Thermal Insulation (APPLICATOR)	Municipality License	Y
Location: Riyadh KSA	Other Licenses (Specify):	Y
Experience (Total No. of Years): 30 Years	Please refer to PQD documents.	
Experience in KSA: 30 Years		
Contact Name: GULF CERTE Head Office Riyadh Mobile Number: 966 599281826 (Shah Rukh Ali Hassan)		
Is the company certified against any quality standard? Yes	Pre-Qualification Doc's (Specify):	Y
Is the company certified against any Health & Safety and Environment standard? Yes	Please refer to PQD documents.	
<b>Subcontractors / Supplier's Proposed Scope of Work in this project</b>		
- Waterproofing & Damp proofing – EPDM – TPO- FPO – POLYUREA - Spray Polyurethane foam Waterproofing - Geosynthetic Engineering - Concrete Repair and Protection – injection work - Building Renovations - Expansion joint – fire proof – decorative and protective epoxy coating - Stamped Concrete - Light Weight Foam Concrete		
	Completion Certificates for Previous Projects	Y

Contractor Signatures & Stamp			
Discipline Engineer	QA/ QC	HSE	Construction Manager

**Submittal Status:**  
 A - Approved   
 B - Approved as Noted   
 C - Revise and Resubmit   
 D - Rejected

**Engineer's Comments:** Complied our previous comments, contractor to keep all the documentation updated.

**PMO/Client' Comments:**

Name	Signature	Date

Client : National Housing Company	PMC : Dar al-handasah	Consultant : Khatib & Alami	General Contractor : Tamimi Global Company Ltd.
<b>SUPPLIER PRE-QUALIFICATION</b>			
AR	ME	CV	LA
ST	EE	QS	OT
To: Khatib & Alami		From: Tamimi Global Company Ltd.	
<b>Supplier Description</b>		<b>Attachments</b>	
Name: GULF CRETE LTD THE SPECIALIZED CO.		<input checked="" type="checkbox"/> Company Profile	
Telephone No.: 0114655034		<input checked="" type="checkbox"/> Valid Commercial Registration Certificate	
Address: RIYADH-KSA		<input checked="" type="checkbox"/> Valid Membership of Chamber of Commerce	
Person in Charge and His Mobile No: 599281826		<input checked="" type="checkbox"/> Valid VAT Registration Certificate	
Supplier's Qualifying Log:		<input checked="" type="checkbox"/> Valid Zakat & Tax Certificate	
Years of Experience (In Total): 20 YEARS		<input checked="" type="checkbox"/> Valid General Organization of Social Insurance	
Years of Experience In Saudi Arabia: 20 YEARS		<input checked="" type="checkbox"/> Valid Saudization Certificate	
		<input type="checkbox"/> Valid Contractor Classification Certificate	
		<input type="checkbox"/> Valid SASO Certificate	
		<input checked="" type="checkbox"/> Authorized Signatory of Responsible Person	
<b>Material to Supply: WATERPROOFING, INSULATION, FIREPROOFING, CONCRETE REPAIRS, AND FLOOR COATINGS</b>			
Approval of Supplier does not relieve contractor of his responsibilities under contract's terms.			
Contractor's Remarks: Hardcopy of company profil (3) , cd -softcopy (3)			
Contractor Incoming Signature:		Contractor Outgoing Signature:	
Date: 14/7/20		Date:	
Consultant Comments: MURCIA HOUSING PROJECT			
<p>• SUPPLIER APPROVED TO PROVIDE THE ABOVE MENTIONED MATERIAL.</p> <p>• MATERIAL TO BE PROVIDED AND AREA OF APPLICATION IS SUBJECT TO CONSULTANT APPROVAL.</p> <p>• ANY MISSING CERTIFICATE, OR OUTDATED CERTIFICATE TO BE PROVIDED</p>			
For K&A : Signature:		Date: 14/7/20	
<b>ACTION CODE:</b> <input checked="" type="checkbox"/> A = Approved <input type="checkbox"/> C = Resubmit as Noted <input checked="" type="checkbox"/> B = Approved as noted <input type="checkbox"/> D = Disapproved			
NOTE: The Client - National Housing Company (NHC) has the authority to approve/disapprove the supplier without any objection from its sides.			





مستشفى الملك فيصل التخصصي ومركز الأبحاث  
King Faisal Specialist Hospital & Research Centre  
Gen. Org. مؤسسة عامة  
FACILITY PROJECTS MANAGEMENT DIVISION  
PROJECTS SUPERVISION DEPARTMENT  
MBC=38 Fax No. 442-7681 Tel No. 442-7661



Address: P.O.Box 92505, Riyadh City 11663 Saudi Arabia  
Contractor: Equipment & Technical Services Co. (ETECHS)

## Submittal Revision

<b>TO: KING FAISAL SPECIALIST HOSPITAL &amp; RESEARCH CENTER</b>		<b>FROM: Equipment &amp; Technical Services Co. (ETECHS)</b>		
<b>PROJECT TITLE: REPLACEMENT-UPGRADING OF FIRE PROTECTION SYSTEM IN OFFICE AND RESIDENTIAL BUILDINGS</b>		<b>REF.# Contract # C/0060/40 End of Contract</b>		
<b>Submittal No.:</b> SBMT-C/0060/40-0135	<b>Rev # : 0</b>	<b>Submitted Date:</b> 27-Apr-2022		
<b>Type of Submittal :</b> <input type="checkbox"/> Drawing <input type="checkbox"/> Materials <input type="checkbox"/> Samples <input type="checkbox"/> Catalogue <input type="checkbox"/> Mock-up <input type="checkbox"/> Others				
Prequalification				
<b>Trade:</b> <input type="checkbox"/> Arch't <input type="checkbox"/> I.D. <input type="checkbox"/> Str/Cvl <input type="checkbox"/> Elect'rl. <input type="checkbox"/> Mech. <input type="checkbox"/> Safety				
<b>SUBJECT:</b> THERMAL & MOISTURE PROTECTION APPLICATOR				
ITEM No.	DESCRIPTION OF ITEM	TRADE	REVIEWER'S REMARKS	ACTION CODE
1	GULF CRETE LTD.	Arch, Str. Civil	The proposed supplier/applicator is approved with the following requirements: 1.) The supplier shall provide a 10-year warranty attested by the Chamber of Commerce for all completed works. 2.) The supplier's representatives shall be available during the warranty period in case of any defects/water leaks from the completed works. A/C:B	B
<b>CONTRACTOR'S REMARKS FIELD:</b> BOQ Part- 02 DIV.07 THERMAL & MOISTURE PROTECTION Item no.1		<b>WE CERTIFY THAT THE ABOVE SUBMITTED ITEMS HAVE BEEN REVIEWED IN DETAILS &amp; ARE IN CONFORMANCE WITH THE INTENT OF CONTRACT, DRAWING &amp; SPECIFICATION EXCEPT AS OTHERWISE CLEARLY STATED ON CONTRACTOR'S REMARKS FIELD.</b> Mohamed Eldosoky Contractor, Project Manager		
<b>ACTION CODE LEGEND:</b>				
A. Approved as submitted		D. Not approved (Work shall not proceed)		
B. Approved as noted. (Work may proceed, resubmission not required)		E. Others. (Specify)		
C. Approved as noted. (Work may proceed, resubmission required)				
<b>REVIEWED BY: ( PRSD Staff )</b>				

Submittal of Documents or Materials for Approval on

Page 1 of 2  
KFSH-PRSD





مستشفى الملك فيصل التخصصي ومركز الأبحاث  
**King Faisal Specialist Hospital & Research Centre**  
Gen. Org. مؤسسة عامة  
**FACILITY PROJECTS MANAGEMENT DIVISION**  
PROJECTS SUPERVISION DEPARTMENT  
MBC=38 Fax No. 442-7681 Tel No. 442-7661



Address: P.O.Box 92505, Riyadh City 11663 Saudi Arabia  
Contractor: Equipment & Technical Services Co. (ETECHS)

/	/	
Architect/Date	Mechanical Engr. /Date	Project Manager
/	/	
Interior/Date	Electrical Engr. / Date	PM Comment
/	/	
Structural Engr. / Date	Safety Officer / Date	Decision date

Submittal of Documents or Materials for Approval on

Page 2 of 2  
KFSH-PRSD

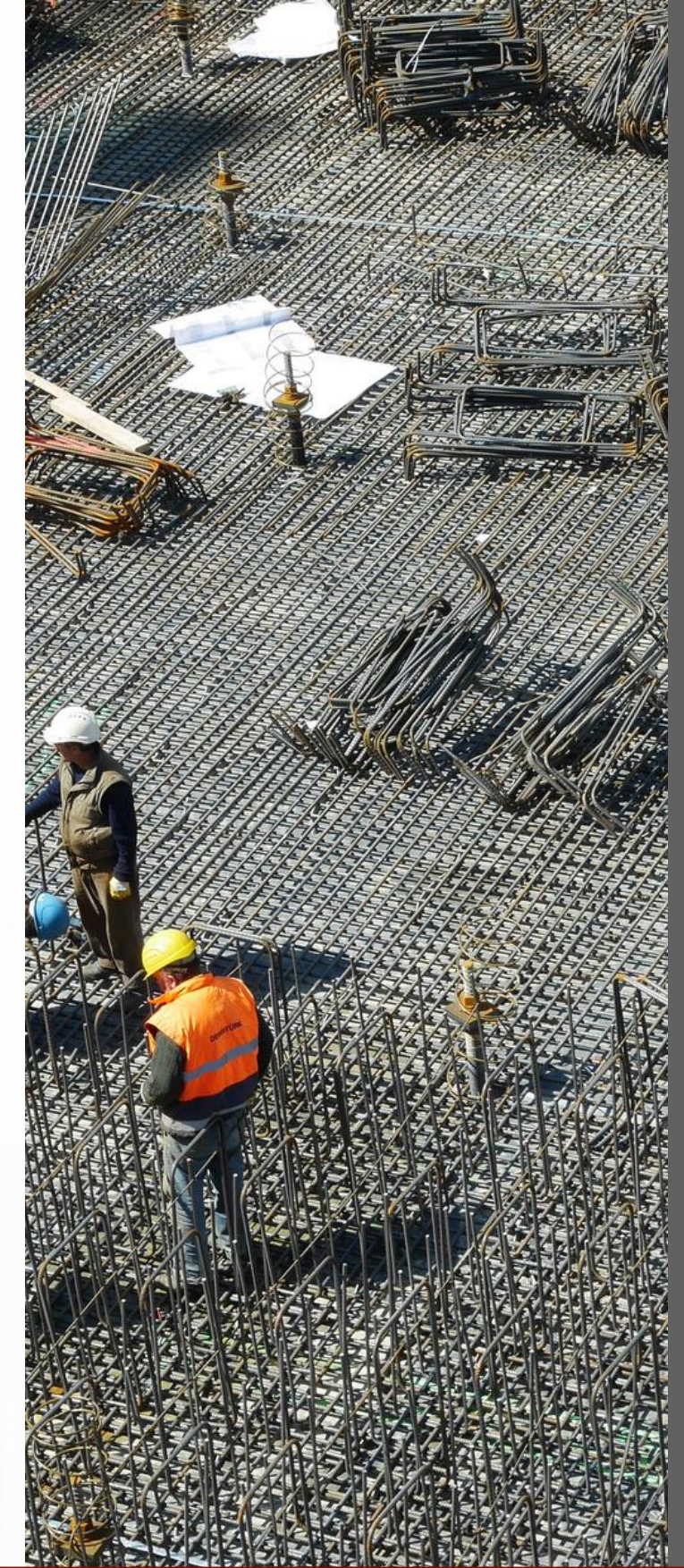

Date and Time Information

Date & Time of Print: 09/08/2021 14:08:21 - Time Zone: Arabia Time

Organisation Details

Organisation Name (English Input will be accepted only)	Gulf Crete Ltd
Trade Market Name (English Input will be accepted only)	Construction, Maintenance
Address	Riyadh
Country	SAUDI ARABIA
Region	منطقة الرياض / Riyadh
ZIP/Postal Code	11323
Main Organisation Phone Number	0114655034
Organisation Fax Number	0112939553
Organisation Email Address	gulfcrite@outlook.com
Web site	www.gulfcrite.com

Organisation Legal Structure

Private Limited or Limited Liability Company (شركة ذات مسؤولية محدودة)

Company Registration Number	1010419075
VAT Number	301099174300003

User Details

Title	Mr.
First Name	
Last Name	
Telephone	0114655034
Mobile	+966599281826
Email	shahrukh@gulfcrite.com
Username	shahrukh@gulfcrite.com
Preferred Language	English (UK)
Time Zone	(GMT + 3:00) Kuwait, Riyadh, Doha, Manama

Contact List

Last Name	First Name	Email	Phone Number
1		shahrukh@gulfcrite.com	0114655034

Registration Date

30/06/2020

List of Forms

No Forms found

Path	Category Title	Last Modification Date	Status Summary	Assessments Present
1	Status Completed MAINTENANCE AND REPAIR FACILITY	11/01/2021	Assessment Status not visible	0
2	Status Completed ADHESIVE AND SEALANTS	11/01/2021	Assessment Status not visible	1
3	Status Completed INTERIOR FINISHING	11/01/2021	Assessment Status not visible	1
4	Status Completed OPERATION AND MAINTINANCE	11/01/2021	Assessment Status not visible	1
5	Status Completed FIRE FIGHTING SYSTEMS	11/01/2021	Assessment Status not visible	1
6	Status Completed CARGO HANDLING FACILITIES	11/01/2021	Assessment Status not visible	1
7	Status Completed TERMINAL	11/01/2021	Assessment Status not visible	1
8	Status Completed CAR PARKING	11/01/2021	Assessment Status not visible	1
9	Status Completed CIVIL WORKS	11/01/2021	Assessment Status not visible	1
10	Status Completed ROOFING MATERIALS	01/07/2020	Assessment Status not visible	1
11	Status Completed PAINTS & COATING SUPPLIES	01/07/2020	Assessment Status not visible	1
12	Status Completed METAL/STEEL STRUCTURE	01/07/2020	Assessment Status not visible	1

Path	Title	Date	Status Summary	Present
13	Status Completed AIRPORTS CONTRACTING	01/07/2020	Assessment Status not visible	1
14	Status Completed MAIN,MINOR SEWERAGE, NETWORK	11/01/2021	Assessment Status not visible	1
15	Status Completed CAR PARKING,OTHER SHADES STRCT	01/07/2020	Assessment Status not visible	1
16	Status Completed HANGERS,WAREHOUSE WORKS	01/07/2020	Assessment Status not visible	1
17	Status Completed MAIN ROADS,STREETS RELATED WRK	11/01/2021	Assessment Status not visible	1
18	Status Completed COOLANT AND ADDITIVES	01/07/2020	Assessment Status not visible	1
19	Status Completed ADHESIVE AND SEALANTS	01/07/2020	Assessment Status not visible	1
20	Status Completed INFRASTRUCTURE,BUILDING WORKS	01/07/2020	Assessment Status not visible	1
21	Status Completed GEOPHYSICAL	11/01/2021	Assessment Status not visible	1
22	Status Completed CAR PARKING SYSTEM	01/07/2020	Assessment Status not visible	1
23	Status Completed JOINTING,PACKING	11/01/2021	Assessment Status not visible	1
24	Status Completed VESSELS AND TANKS	01/07/2020	Assessment Status not visible	1
25	Status Completed DIGGING AND PILING WORKS	11/01/2021	Assessment Status not visible	1
26	Status Completed RESIDENT ENGINEERING SERVICES	11/01/2021	Assessment Status not visible	1
27	Status Completed MASONRY,STONE WORK TILE	01/07/2020	Assessment Status not visible	1
28	Status Completed MAINTENANCE SERVICES	11/01/2021	Assessment Status not visible	1
29	Status Completed MATERIALS	01/07/2020	Assessment Status not visible	1
30	Status Completed CLADDING WORKS	01/07/2020	Assessment Status not visible	1
31	Status Completed FORWARDING FACILITY	11/01/2021	Assessment Status not visible	1
32	Status Completed GENERAL WORKS	01/07/2020	Assessment Status not visible	1
33	Status Completed INDUSTRIAL WORKS	01/07/2020	Assessment Status not visible	1
34	Status Completed ROAD MARKINGS	01/07/2020	Assessment Status not visible	1
35	Status Completed EXTERIOR RENOVATION WORKS	11/01/2021	Assessment Status not visible	1
36	Status Completed INTERIOR RENOVATION WORKS	11/01/2021	Assessment Status not visible	1
37	Status Completed FIRE SUPPRESSION SYSTEMS	11/01/2021	Assessment Status not visible	1
38	Status Completed CARPET AND FLOORING	11/01/2021	Assessment Status not visible	1
39	Status Completed TOPOGRAPHIC & OTHER	11/01/2021	Assessment Status not visible	1
40	Status Completed PAINT	01/07/2020	Assessment Status not visible	0
41	Status Completed SEALANT	11/01/2021	Assessment Status not visible	0
42	Status Completed SEALER	11/01/2021	Assessment Status not visible	0
43	Status Completed SEAL	11/01/2021	Assessment Status not visible	0
44	Status Completed JOINT	11/01/2021	Assessment Status not visible	0
45	Status Completed INSULATION	01/07/2020	Assessment Status not visible	0

No Segmentation Assessment found

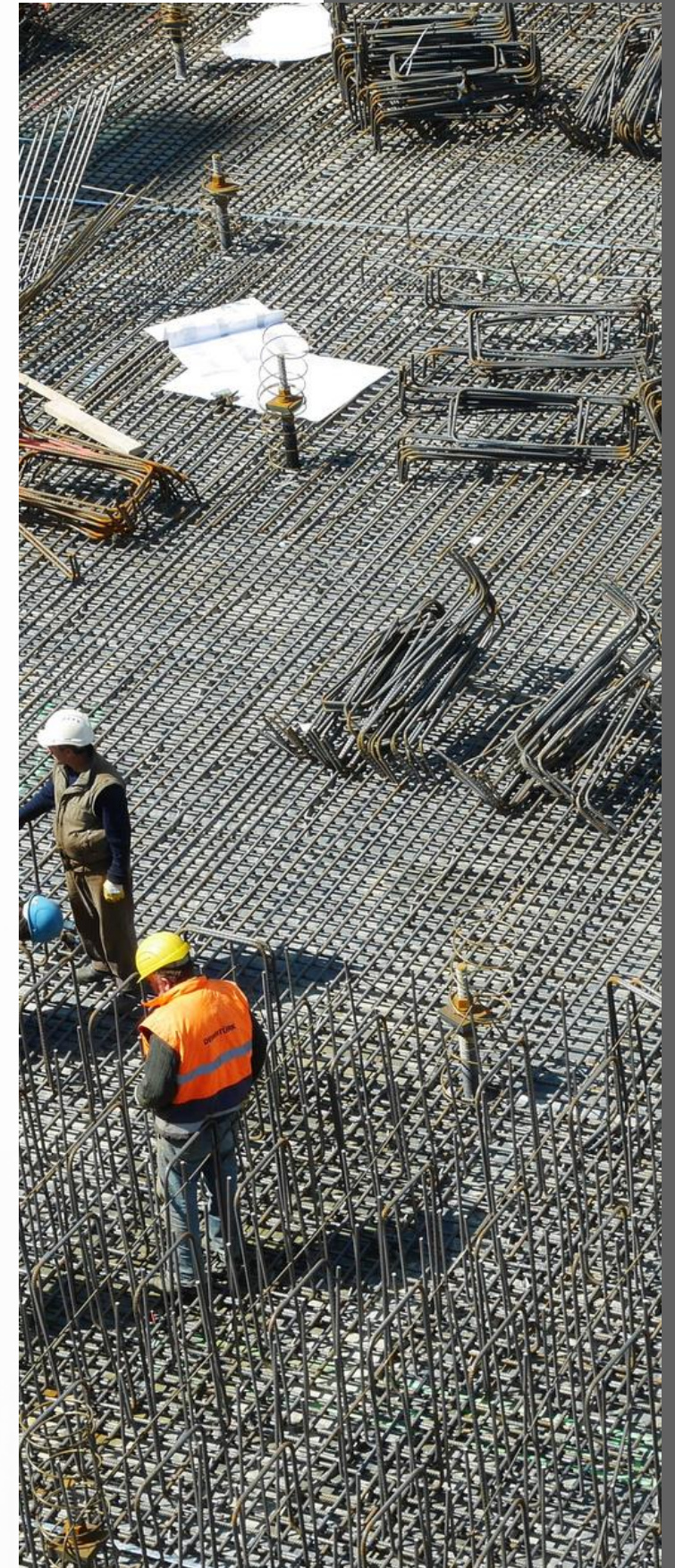

Date and Time Information

Date & Time of Print: 09/08/2021 14:08:21 - Time Zone: Arabia Time

Organisation Details

Organisation Name (English Input will be accepted only)	Gulf Crete Ltd
Trade Market Name (English Input will be accepted only)	Construction, Maintenance
Address	Riyadh
Country	SAUDI ARABIA
Region	منطقة الرياض / Riyadh
ZIP/Postal Code	11323
Main Organisation Phone Number	0114655034
Organisation Fax Number	0112939553
Organisation Email Address	gulfcrite@outlook.com
Web site	www.gulfcrite.com

Organisation Legal Structure

Private Limited or Limited Liability Company (شركة ذات مسؤولية محدودة)

Company Registration Number	1010419075
VAT Number	301099174300003

User Details

Title	Mr.
First Name	
Last Name	
Telephone	0114655034
Mobile	+966599281826
Email	shahrukh@gulfcrite.com
Username	shahrukh@gulfcrite.com
Preferred Language	English (UK)
Time Zone	(GMT + 3:00) Kuwait, Riyadh, Doha, Manama

Contact List

Last Name	First Name	Email	Phone Number
1		shahrukh@gulfcrite.com	0114655034

Registration Date

30/06/2020

List of Forms

No Forms found

Path	Category Title	Last Modification Date	Status Summary	Assessments Present
1	Status Completed MAINTENANCE AND REPAIR FACILITY	11/01/2021	Assessment Status not visible	0
2	Status Completed ADHESIVE AND SEALANTS	11/01/2021	Assessment Status not visible	1
3	Status Completed INTERIOR FINISHING	11/01/2021	Assessment Status not visible	1
4	Status Completed OPERATION AND MAINTINANCE	11/01/2021	Assessment Status not visible	1
5	Status Completed FIRE FIGHTING SYSTEMS	11/01/2021	Assessment Status not visible	1
6	Status Completed CARGO HANDLING FACILITIES	11/01/2021	Assessment Status not visible	1
7	Status Completed TERMINAL	11/01/2021	Assessment Status not visible	1
8	Status Completed CAR PARKING	11/01/2021	Assessment Status not visible	1
9	Status Completed CIVIL WORKS	11/01/2021	Assessment Status not visible	1
10	Status Completed ROOFING MATERIALS	01/07/2020	Assessment Status not visible	1
11	Status Completed PAINTS & COATING SUPPLIES	01/07/2020	Assessment Status not visible	1
12	Status Completed METAL/STEEL STRUCTURE	01/07/2020	Assessment Status not visible	1

Path	Title	Date	Status Summary	Present
13	Status Completed AIRPORTS CONTRACTING	01/07/2020	Assessment Status not visible	1
14	Status Completed MAIN,MINOR SEWERAGE, NETWORK	11/01/2021	Assessment Status not visible	1
15	Status Completed CAR PARKING,OTHER SHADES STRCT	01/07/2020	Assessment Status not visible	1
16	Status Completed HANGERS,WAREHOUSE WORKS	01/07/2020	Assessment Status not visible	1
17	Status Completed MAIN ROADS,STREETS RELATED WRK	11/01/2021	Assessment Status not visible	1
18	Status Completed COOLANT AND ADDITIVES	01/07/2020	Assessment Status not visible	1
19	Status Completed ADHESIVE AND SEALANTS	01/07/2020	Assessment Status not visible	1
20	Status Completed INFRASTRUCTURE,BUILDING WORKS	01/07/2020	Assessment Status not visible	1
21	Status Completed GEOPHYSICAL	11/01/2021	Assessment Status not visible	1
22	Status Completed CAR PARKING SYSTEM	01/07/2020	Assessment Status not visible	1
23	Status Completed JOINTING,PACKING	11/01/2021	Assessment Status not visible	1
24	Status Completed VESSELS AND TANKS	01/07/2020	Assessment Status not visible	1
25	Status Completed DIGGING AND PILING WORKS	11/01/2021	Assessment Status not visible	1
26	Status Completed RESIDENT ENGINEERING SERVICES	11/01/2021	Assessment Status not visible	1
27	Status Completed MASONRY,STONE WORK TILE	01/07/2020	Assessment Status not visible	1
28	Status Completed MAINTENANCE SERVICES	11/01/2021	Assessment Status not visible	1
29	Status Completed MATERIALS	01/07/2020	Assessment Status not visible	1
30	Status Completed CLADDING WORKS	01/07/2020	Assessment Status not visible	1
31	Status Completed FORWARDING FACILITY	11/01/2021	Assessment Status not visible	1
32	Status Completed GENERAL WORKS	01/07/2020	Assessment Status not visible	1
33	Status Completed INDUSTRIAL WORKS	01/07/2020	Assessment Status not visible	1
34	Status Completed ROAD MARKINGS	01/07/2020	Assessment Status not visible	1
35	Status Completed EXTERIOR RENOVATION WORKS	11/01/2021	Assessment Status not visible	1
36	Status Completed INTERIOR RENOVATION WORKS	11/01/2021	Assessment Status not visible	1
37	Status Completed FIRE SUPPRESSION SYSTEMS	11/01/2021	Assessment Status not visible	1
38	Status Completed CARPET AND FLOORING	11/01/2021	Assessment Status not visible	1
39	Status Completed TOPOGRAPHIC & OTHER	11/01/2021	Assessment Status not visible	1
40	Status Completed PAINT	01/07/2020	Assessment Status not visible	0
41	Status Completed SEALANT	11/01/2021	Assessment Status not visible	0
42	Status Completed SEALER	11/01/2021	Assessment Status not visible	0
43	Status Completed SEAL	11/01/2021	Assessment Status not visible	0
44	Status Completed JOINT	11/01/2021	Assessment Status not visible	0
45	Status Completed INSULATION	01/07/2020	Assessment Status not visible	0

No Segmentation Assessment found

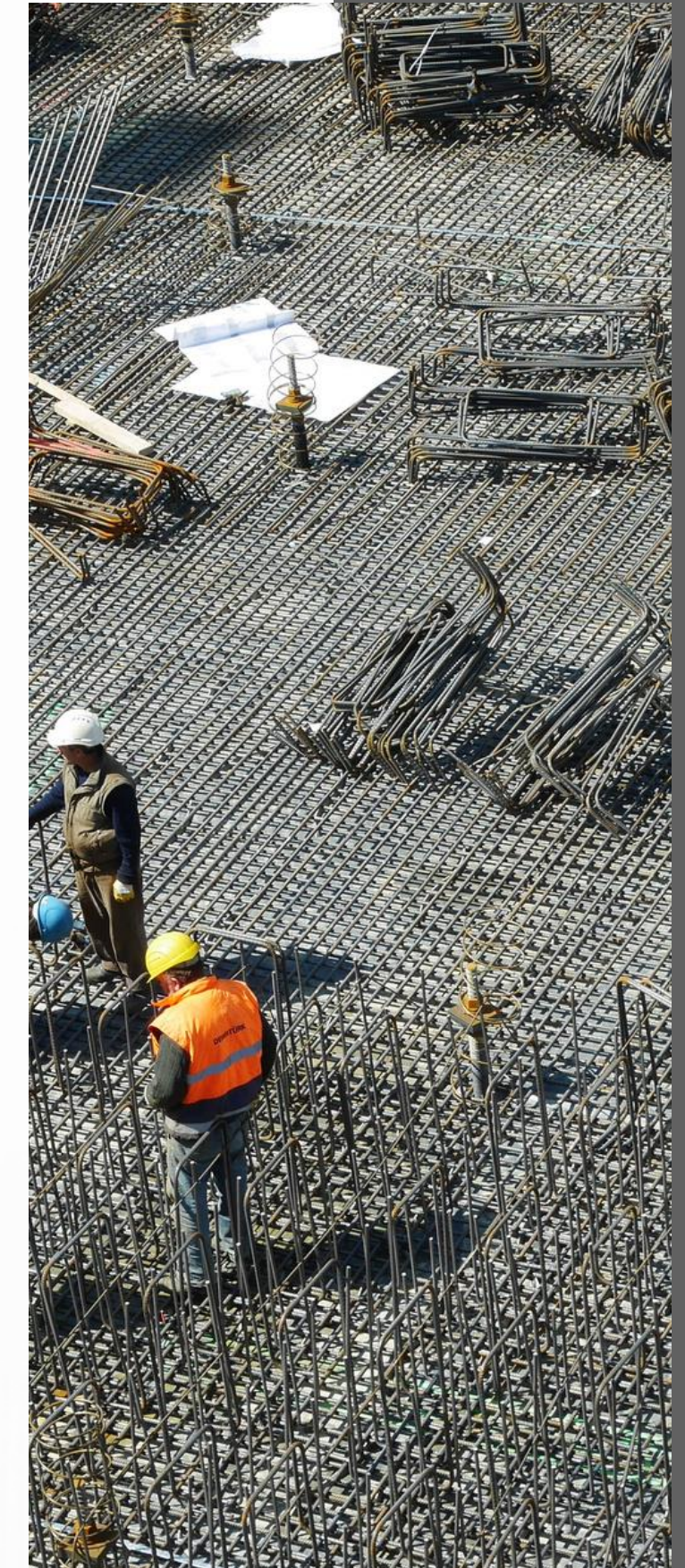



# CERTIFICATE

FOR RECOMMENDED SIKA APPLICATORS

This is to certify that

**GULF CRETE CONTRACTING**

Has successfully executed many Projects after having passed the application training of various Sika systems and is Recommended Sika Applicator for

**Concrete repair and protection, Waterproofing (PVC membranes loose laid and full compartment system), Cementitious, Resins, Combiflex range), Joint Sealants and Industrial flooring.**

This comprehensive training consisted of practical instructions about proper storage, preparation and application of Sika products.

The recommended applicator has been provided with the relevant Sika Product Data Sheets and all other technical documentation.

This confirmation is valid until the date of expiry below and may be renewed subject to the Recommended Applicator successfully completing any training courses required by Sika. The Recommended Applicator is responsible for ensuring full compliance by its employees with Sika's guidelines, training instructions and any other requirements of third parties.

Sika is not responsible for any loss or damage suffered by any third party as a result of any acts or omissions of the Recommended Applicator arising in anyway, including but not limited to breach of contract, misrepresentation, failure to comply with applicable laws or any other tort including negligence.

Sika Saudi Arabia,

Issuing Date: January 01, 2016      Expiry Date: December 31, 2016



**Shehadeh Salman**  
T.M Waterproofing Manager  
Central Region  
Sika Saudi Arabia



**Emad Al Asqar**  
Sr. Sales Manager  
Central Region  
Sika Saudi Arabia

This Recommendation does not assume responsibility for the correct storage, mixing or use of these Products. Sika shall not be liable for damage to persons or property, loss of business or profit or any other direct, indirect, incidental, special or consequential damage as caused by the Recommended Applicator. Sika shall also not be responsible for use of these Products in a manner to infringe on any patent or other intellectual property rights held by others. Sika's liability is limited to the quality only of the supplied material. Any failures due to wrong application or storage not in accordance with the given guidelines as stated on the latest Technical Data Sheets, as well as structural or mechanical failures are excluded herein.



**BUILDING TRUST**





Date: 19\2\2015

Project: KAFD Parcel: 1.11

Attention: **DAR AL-Riyadh**  
Contractor: **Specialized Contracting Company**  
Applicator: **Gulf Crete**  
Subject: **Inspection for the steel structure at levels 7,8,9,10**

Dear Sir,

We would to confirm that the application of the fireproof paint for the levels 7,8,9,10 has been done as per the method of Statements and already achieved all the required DFT to have 2 hours fire proof and now we can go for the top coat paint

Best Regards,

Technical Service department  
Protective Coating Dept.  
Jotun Saudia Co. Ltd.,  
Riyadh-Saudi Arabia.

Tel : + 966 (11) 2445883  
Fax : + 966 (11) 2709089  
Website : www.jotun.com



**Jotun Saudia Co. Ltd.**  
C.R. No. 4030088863 - Industrial License 131031026674  
Capital: SR. 9,000,000 Fully Paid Up  
Tel: (+966) 2 4350535 Fax: (+966) 2 4362484  
P.O. Box 18498, Jeddah, 21428  
Kingdom of Saudi Arabia

Following are our Bank Accounts:  
S.H.R. IBAN No: SA 56 5000 0000 0610 0933 4330  
Riyadh Bank IBAN No: SA 36 2000 0001 0128 3276 9901  
N.C.B. IBAN No: SA 36 1000 0010 1250 3200 0109

**شركة جوتن السعودية المحدودة**  
سجل تجاري رقم 4030088863 - رخصة صناعية 131031026674  
رأس المال: 9,000,000 ريال سعودي مدفوع بالكامل  
الهاتف: (+966) 2 4350535 - الفاكس: (+966) 2 4362484  
ص.ب. 18498 - جدة 21428  
المملكة العربية السعودية

أرقام حساباتنا البنكية:

البنك السعودي التجاري: IBAN No: SA 56 5000 0000 0610 0933 4330  
بنك الرياض: IBAN No: SA 36 2000 0001 0128 3276 9901  
بنك الأهلي السعودي: IBAN No: SA 36 1000 0010 1250 3200 0109



CERTIFICATION

Consultant Strategic Construction Program		Client Inmofahk'arah		Contractor Shargawi E/M Qituf Al Jazeera	
PROJECT NO:		LOCATION: RIYADH- KSA			
PROJECT NAME: KSUEH- BUILDING 04					
<b>MATERIALS SUBMITTAL</b>					
<input checked="" type="checkbox"/> SUBMITTAL		SUBMITTAL NO: KSUHH-AS-AR-0010		PREV. SUBMITTAL NO:	
<input type="checkbox"/> RESUBMITTAL		DATE: 19 Feb-17		PREV. SUB. AL. DATE:	
Submittal reason: <input type="checkbox"/> INFO		<input type="checkbox"/> NOTES		<input checked="" type="checkbox"/> APPROVAL	
Major: <input type="checkbox"/> CV <input checked="" type="checkbox"/> AR <input type="checkbox"/> ST <input type="checkbox"/> AC <input type="checkbox"/> EL <input type="checkbox"/> PL <input type="checkbox"/> OTHER					
Attachments: <input type="checkbox"/> Brochure <input checked="" type="checkbox"/> Tech. Info <input type="checkbox"/> Sample <input checked="" type="checkbox"/> Certificate <input type="checkbox"/> Drawing <input type="checkbox"/> Calculations					
Materials/Tools					
Serial	Material Name, Number & Description	Source	Supplier / Manufacturer	Specs. Ref	Code Status
1	Concrete Repair	Local	Gulf Crete LTD.		B
2	Protective Coating (Epoxy)				
3	Fire Proofing				
4	Water Proofing				
					
CONTRACTOR			PROJECT MANAGER		
Procurement Manager			Name: Ayman Shaban		
Name:			Site Engr.: Muhamed Zyadeh		
Signature:			Signature:		
CONSULTANT NOTES					
<p><i>*Accepted as a subcontractor and to be provide complete information and materials details and data sheet for review and approval.</i></p> <p><i>*provide warranty certificate as per project spec and Contract.</i></p>					
CONSULTANT			STRATEGIC CONSTRUCTION PROGRAM		
Name: Avazag Najjar			Date:		
Position: Arch			Signature:		
Signature:			ENG. KHALID FAHD AL-SHAIDDI		
Date: 2/2/2017			General Manager of Strategic Construction Program		
APPROVAL SITUATION					
<input checked="" type="checkbox"/> APPROVED		<input type="checkbox"/> REJECTED			
<input type="checkbox"/> APP. WITH COMMENTS		<input type="checkbox"/> NO ACTION			
<input type="checkbox"/> APP. AS NOTED/RESUBMITTAL REQUIRED					
INCOMING SIGNATURE:		OUTGOING SIGNATURE:			
DATE:		DATE:			
<small>Consultant: Original    Contractor: Copy with Stamp    Consultant Site Office: Copy          (Authority to proceed with work does not relieve the contractor from contractual responsibilities)</small>					



CERTIFICATION

  
 AL-JAZEERA PAINTS

Date : 23/11/2013  
Ref. # : GSM-AG-87-14

**CERTIFICATION**

TO WHOM SO IT MAY CONCERN :

This is to certify that **M/S. Gulf Crete Ltd Co.** Is our qualified paint Contractor / applicator in **Protective coatings & intumescent fire proof** in the kingdom of Saudi Arabia .

This certification is valid for 1 year and will be subject to review on 23/11/2015

Furthermore, this recommendation is made by Al-Jazeera paints Co. without Prejudice / or legal liability.

**Ahmed Taleb**  
Projects General Manager

  
 www.gulfcrete.com

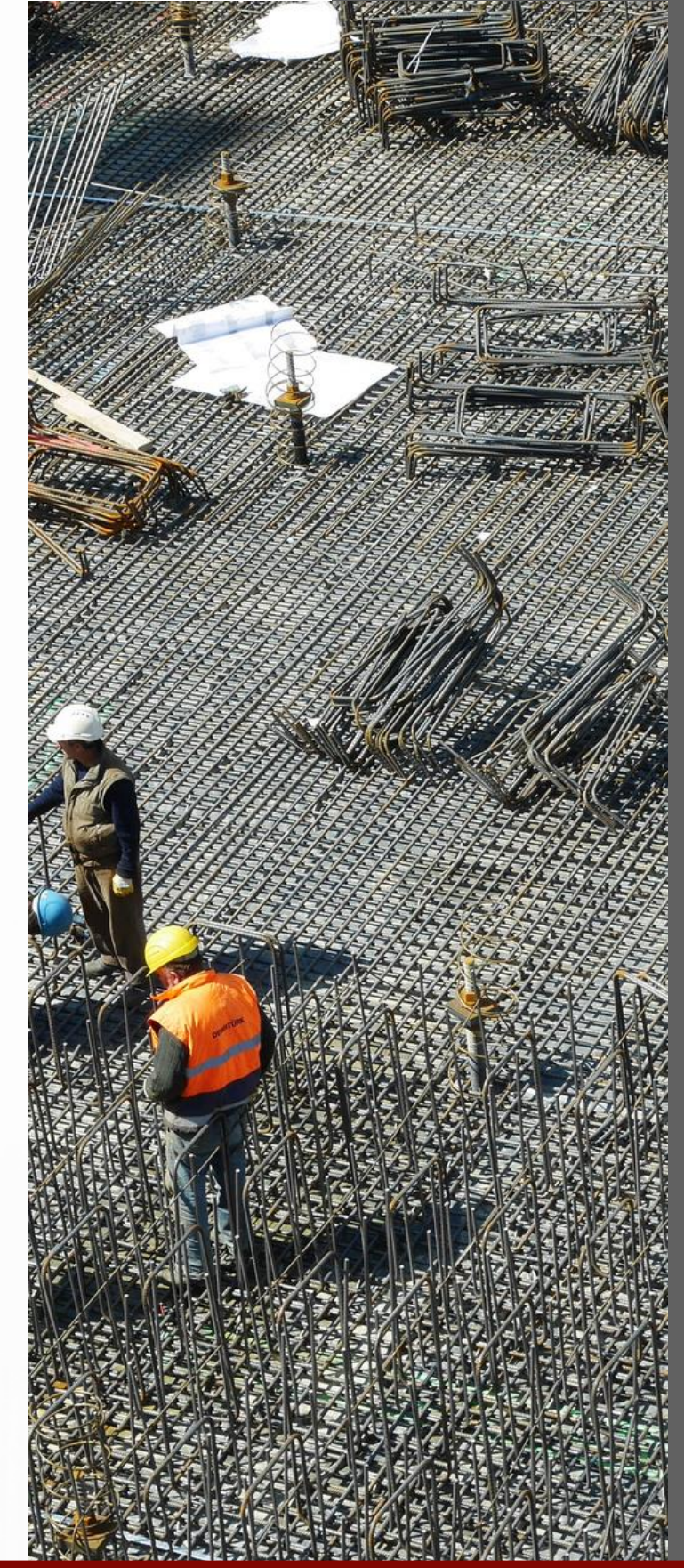

Date and Time Information

Date & Time of Print: 09/08/2021 14:08:21 - Time Zone: Arabia Time

Organisation Details

Organisation Name (English Input will be accepted only)	Gulf Crete Ltd
Trade Market Name (English Input will be accepted only)	Construction, Maintenance
Address	Riyadh
Country	SAUDI ARABIA
Region	Riyadh / منطقة الرياض
ZIP/Postal Code	11323
Main Organisation Phone Number	0114655034
Organisation Fax Number	0112939553
Organisation Email Address	gulfcrite@outlook.com
Web site	www.gulfcrite.com

Organisation Legal Structure

Private Limited or Limited Liability Company (شركة ذات مسؤولية محدودة)

Company Registration Number	1010419075
VAT Number	301099174300003

User Details

Title	Mr.
First Name	
Last Name	
Telephone	0114655034
Mobile	+966599281826
Email	shahrukh@gulfcrite.com
Username	shahrukh@gulfcrite.com
Preferred Language	English (UK)
Time Zone	(GMT + 3:00) Kuwait, Riyadh, Doha, Manama

Contact List

Last Name	First Name	Email	Phone Number
1		shahrukh@gulfcrite.com	0114655034

Registration Date

30/06/2020

List of Forms

No Forms found

Path	Category Title	Last Modification Date	Status Summary	Assessments Present
1	Status Completed MAINTENANCE AND REPAIR FACILITY	11/01/2021	Assessment Status not visible	0
2	Status Completed ADHESIVE AND SEALANTS	11/01/2021	Assessment Status not visible	1
3	Status Completed INTERIOR FINISHING	11/01/2021	Assessment Status not visible	1
4	Status Completed OPERATION AND MAINTINANCE	11/01/2021	Assessment Status not visible	1
5	Status Completed FIRE FIGHTING SYSTEMS	11/01/2021	Assessment Status not visible	1
6	Status Completed CARGO HANDLING FACILITIES	11/01/2021	Assessment Status not visible	1
7	Status Completed TERMINAL	11/01/2021	Assessment Status not visible	1
8	Status Completed CAR PARKING	11/01/2021	Assessment Status not visible	1
9	Status Completed CIVIL WORKS	11/01/2021	Assessment Status not visible	1
10	Status Completed ROOFING MATERIALS	01/07/2020	Assessment Status not visible	1
11	Status Completed PAINTS & COATING SUPPLIES	01/07/2020	Assessment Status not visible	1
12	Status Completed METAL/STEEL STRUCTURE	01/07/2020	Assessment Status not visible	1

Path	Title	Date	Status Summary	Present
13	Status Completed AIRPORTS CONTRACTING	01/07/2020	Assessment Status not visible	1
14	Status Completed MAIN,MINOR SEWERAGE, NETWORK	11/01/2021	Assessment Status not visible	1
15	Status Completed CAR PARKING,OTHER SHADES STRCT	01/07/2020	Assessment Status not visible	1
16	Status Completed HANGERS,WAREHOUSE WORKS	01/07/2020	Assessment Status not visible	1
17	Status Completed MAIN ROADS,STREETS RELATED WRK	11/01/2021	Assessment Status not visible	1
18	Status Completed COOLANT AND ADDITIVES	01/07/2020	Assessment Status not visible	1
19	Status Completed ADHESIVE AND SEALANTS	01/07/2020	Assessment Status not visible	1
20	Status Completed INFRASTRUCTURE,BUILDING WORKS	01/07/2020	Assessment Status not visible	1
21	Status Completed GEOPHYSICAL	11/01/2021	Assessment Status not visible	1
22	Status Completed CAR PARKING SYSTEM	01/07/2020	Assessment Status not visible	1
23	Status Completed JOINTING,PACKING	11/01/2021	Assessment Status not visible	1
24	Status Completed VESSELS AND TANKS	01/07/2020	Assessment Status not visible	1
25	Status Completed DIGGING AND PILING WORKS	11/01/2021	Assessment Status not visible	1
26	Status Completed RESIDENT ENGINEERING SERVICES	11/01/2021	Assessment Status not visible	1
27	Status Completed MASONRY,STONE WORK TILE	01/07/2020	Assessment Status not visible	1
28	Status Completed MAINTENANCE SERVICES	11/01/2021	Assessment Status not visible	1
29	Status Completed MATERIALS	01/07/2020	Assessment Status not visible	1
30	Status Completed CLADDING WORKS	01/07/2020	Assessment Status not visible	1
31	Status Completed FORWARDING FACILITY	11/01/2021	Assessment Status not visible	1
32	Status Completed GENERAL WORKS	01/07/2020	Assessment Status not visible	1
33	Status Completed INDUSTRIAL WORKS	01/07/2020	Assessment Status not visible	1
34	Status Completed ROAD MARKINGS	01/07/2020	Assessment Status not visible	1
35	Status Completed EXTERIOR RENOVATION WORKS	11/01/2021	Assessment Status not visible	1
36	Status Completed INTERIOR RENOVATION WORKS	11/01/2021	Assessment Status not visible	1
37	Status Completed FIRE SUPPRESSION SYSTEMS	11/01/2021	Assessment Status not visible	1
38	Status Completed CARPET AND FLOORING	11/01/2021	Assessment Status not visible	1
39	Status Completed TOPOGRAPHIC & OTHER	11/01/2021	Assessment Status not visible	1
40	Status Completed PAINT	01/07/2020	Assessment Status not visible	0
41	Status Completed SEALANT	11/01/2021	Assessment Status not visible	0
42	Status Completed SEALER	11/01/2021	Assessment Status not visible	0
43	Status Completed SEAL	11/01/2021	Assessment Status not visible	0
44	Status Completed JOINT	11/01/2021	Assessment Status not visible	0
45	Status Completed INSULATION	01/07/2020	Assessment Status not visible	0

No Segmentation Assessment found

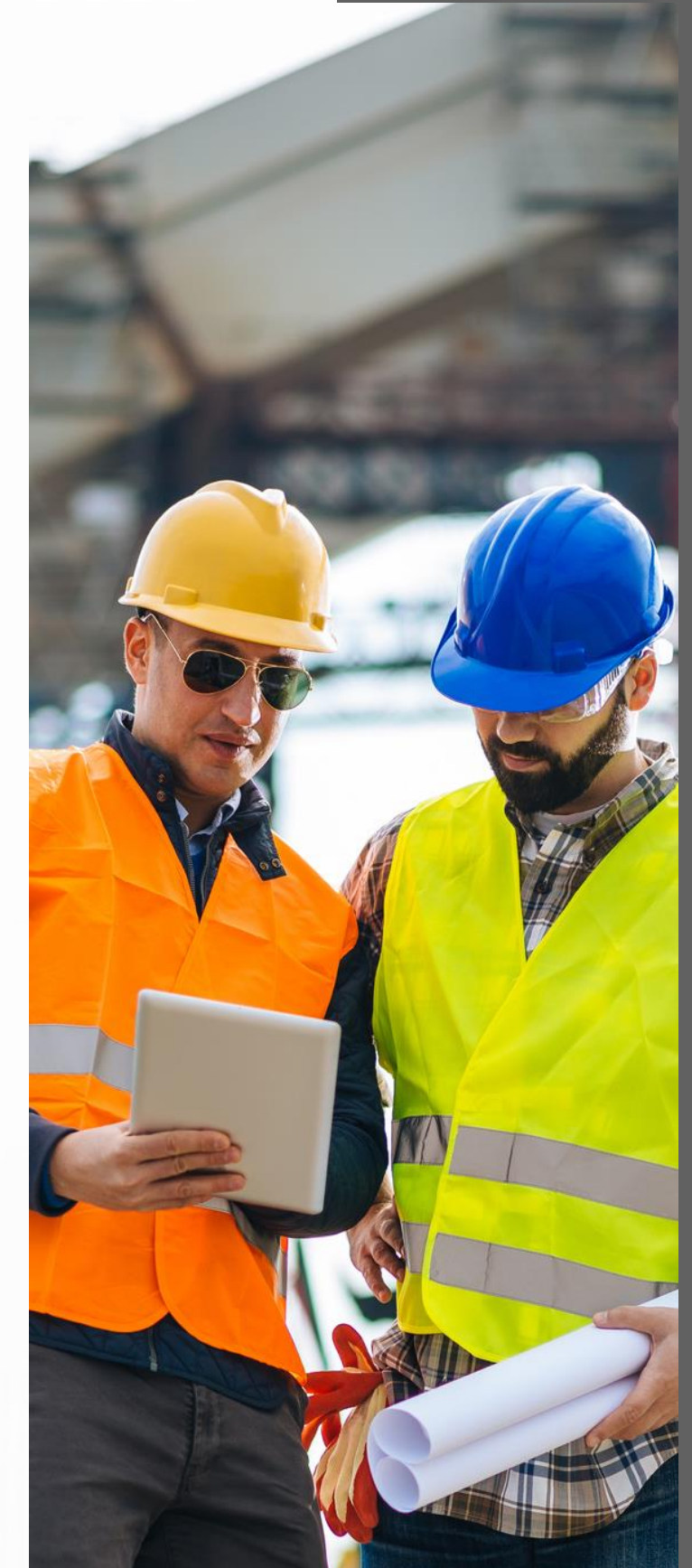

# CERTIFICATE

FOR RECOMMENDED SIKA APPLICATORS

---

This is to certify that

**GULF CRETE CONTRACTING**

Has successfully executed many Projects after having passed the application training of various Sika systems and is Recommended Sika Applicator for

**Concrete repair and protection, Waterproofing (PVC membranes loose laid and full compartment system), Cementitious, Resins, Combiflex range), Joint Sealants and Industrial flooring.**

This comprehensive training consisted of practical instructions about proper storage, preparation and application of Sika products.

The recommended applicator has been provided with the relevant Sika Product Data Sheets and all other technical documentation.

This confirmation is valid until the date of expiry below and may be renewed subject to the Recommended Applicator successfully completing any training courses required by Sika. The Recommended Applicator is responsible for ensuring full compliance by its employees with Sika's guidelines, training instructions and any other requirements of third parties.

Sika is not responsible for any loss or damage suffered by any third party as a result of any acts or omissions of the Recommended Applicator arising in anyway, including but not limited to breach of contract, misrepresentation, failure to comply with applicable laws or any other tort including negligence.

Sika Saudi Arabia,

Issuing Date: January 01, 2016      Expiry Date: December 31, 2016



**Shehadeh Salman**  
T.M Waterproofing Manager  
Central Region  
Sika Saudi Arabia



**Emad Al Asqar**  
Sr. Sales Manager  
Central Region  
Sika Saudi Arabia

This Recommendation does not assume responsibility for the correct storage, mixing or use of these Products. Sika shall not be liable for damage to persons or property, loss of business or profits or any other direct, indirect, incidental, special or consequential damage or caused by the Recommended Applicator. Sika shall also not be responsible for use of these Products in a manner to infringe on any patent or other intellectual property rights held by others. Sika's liability is limited to the quality only of the supplied material. Any failures due to wrong application or storage not in accordance with the given guidelines as stated on the latest Technical Data Sheets, as well as structural or mechanical failures are excluded herein.

BUILDING TRUST





Constructive solutions

Ref : AY/06/22

Date: June 21, 2022.

TO WHOM IT MAY CONCERN

This is to certify that M/s. **Gulfcrete** have considered as our certified and approved applicator for following Fosam Products' Range as below:

- Concrete Repair.
- Protective Coatings.
- Industrial Flooring.
- Joint Sealants.

This certificate is issued upon their request without any liabilities on Fosam Company Limited and valid for six months from the date of issuance of this certificate.

Yours sincerely,  
For Fosam Company Limited



Fosam Company Limited  
Head Office  
PO Box 51081  
Jeddah - 21452  
Saudi Arabia  
C.R. No. 31273  
Paid up Capital: SR3,000,000  
[www.fosroc.com](http://www.fosroc.com)

ت: 482-9903 181-1302  
C.R. No. 31273 - P.O. Box 55301 Riyadh  
شركة فوسام المحدودة  
Fosam Company Limited  
صندوق بريد 51081 جدة  
السعودية

Fax: +966 (0) 527 5528  
Tel: +966 (0) 527 5534  
Email: [saudi@fosroc.com](mailto:saudi@fosroc.com)



Date and Time Information

Date & Time of Print: 09/08/2021 14:08:21 - Time Zone: Arabia Time

Organisation Details

Organisation Name (English Input will be accepted only)	Gulf Crete Ltd
Trade Market Name (English Input will be accepted only)	Construction, Maintenance
Address	Riyadh
Country	SAUDI ARABIA
Region	منطقة الرياض / Riyadh
ZIP/Postal Code	11323
Main Organisation Phone Number	0114655034
Organisation Fax Number	0112939553
Organisation Email Address	gulfcrite@outlook.com
Web site	www.gulfcrite.com

Organisation Legal Structure

Private Limited or Limited Liability Company (شركة ذات مسؤولية محدودة)

Company Registration Number	1010419075
VAT Number	301099174300003

User Details

Title	Mr.
First Name	
Last Name	
Telephone	0114655034
Mobile	+966599281826
Email	shahrukh@gulfcrite.com
Username	shahrukh@gulfcrite.com
Preferred Language	English (UK)
Time Zone	(GMT + 3:00) Kuwait, Riyadh, Doha, Manama

Contact List

Last Name	First Name	Email	Phone Number
1		shahrukh@gulfcrite.com	0114655034

Registration Date

30/06/2020

List of Forms

No Forms found

Path	Category Title	Last Modification Date	Status Summary	Assessments Present
1	Status Completed MAINTENANCE AND REPAIR FACILITY	11/01/2021	Assessment Status not visible	0
2	Status Completed ADHESIVE AND SEALANTS	11/01/2021	Assessment Status not visible	1
3	Status Completed INTERIOR FINISHING	11/01/2021	Assessment Status not visible	1
4	Status Completed OPERATION AND MAINTINANCE	11/01/2021	Assessment Status not visible	1
5	Status Completed FIRE FIGHTING SYSTEMS	11/01/2021	Assessment Status not visible	1
6	Status Completed CARGO HANDLING FACILITIES	11/01/2021	Assessment Status not visible	1
7	Status Completed TERMINAL	11/01/2021	Assessment Status not visible	1
8	Status Completed CAR PARKING	11/01/2021	Assessment Status not visible	1
9	Status Completed CIVIL WORKS	11/01/2021	Assessment Status not visible	1
10	Status Completed ROOFING MATERIALS	01/07/2020	Assessment Status not visible	1
11	Status Completed PAINTS & COATING SUPPLIES	01/07/2020	Assessment Status not visible	1
12	Status Completed METAL/STEEL STRUCTURE	01/07/2020	Assessment Status not visible	1

Path	Title	Date	Status Summary	Present
13	Status Completed AIRPORTS CONTRACTING	01/07/2020	Assessment Status not visible	1
14	Status Completed MAIN,MINOR SEWERAGE, NETWORK	11/01/2021	Assessment Status not visible	1
15	Status Completed CAR PARKING,OTHER SHADES STRCT	01/07/2020	Assessment Status not visible	1
16	Status Completed HANGERS,WAREHOUSE WORKS	01/07/2020	Assessment Status not visible	1
17	Status Completed MAIN ROADS,STREETS RELATED WRK	11/01/2021	Assessment Status not visible	1
18	Status Completed COOLANT AND ADDITIVES	01/07/2020	Assessment Status not visible	1
19	Status Completed ADHESIVE AND SEALANTS	01/07/2020	Assessment Status not visible	1
20	Status Completed INFRASTRUCTURE,BUILDING WORKS	01/07/2020	Assessment Status not visible	1
21	Status Completed GEOPHYSICAL	11/01/2021	Assessment Status not visible	1
22	Status Completed CAR PARKING SYSTEM	01/07/2020	Assessment Status not visible	1
23	Status Completed JOINTING,PACKING	11/01/2021	Assessment Status not visible	1
24	Status Completed VESSELS AND TANKS	01/07/2020	Assessment Status not visible	1
25	Status Completed DIGGING AND PILING WORKS	11/01/2021	Assessment Status not visible	1
26	Status Completed RESIDENT ENGINEERING SERVICES	11/01/2021	Assessment Status not visible	1
27	Status Completed MASONRY,STONE WORK TILE	01/07/2020	Assessment Status not visible	1
28	Status Completed MAINTENANCE SERVICES	11/01/2021	Assessment Status not visible	1
29	Status Completed MATERIALS	01/07/2020	Assessment Status not visible	1
30	Status Completed CLADDING WORKS	01/07/2020	Assessment Status not visible	1
31	Status Completed FORWARDING FACILITY	11/01/2021	Assessment Status not visible	1
32	Status Completed GENERAL WORKS	01/07/2020	Assessment Status not visible	1
33	Status Completed INDUSTRIAL WORKS	01/07/2020	Assessment Status not visible	1
34	Status Completed ROAD MARKINGS	01/07/2020	Assessment Status not visible	1
35	Status Completed EXTERIOR RENOVATION WORKS	11/01/2021	Assessment Status not visible	1
36	Status Completed INTERIOR RENOVATION WORKS	11/01/2021	Assessment Status not visible	1
37	Status Completed FIRE SUPPRESSION SYSTEMS	11/01/2021	Assessment Status not visible	1
38	Status Completed CARPET AND FLOORING	11/01/2021	Assessment Status not visible	1
39	Status Completed TOPOGRAPHIC & OTHER	11/01/2021	Assessment Status not visible	1
40	Status Completed PAINT	01/07/2020	Assessment Status not visible	0
41	Status Completed SEALANT	11/01/2021	Assessment Status not visible	0
42	Status Completed SEALER	11/01/2021	Assessment Status not visible	0
43	Status Completed SEAL	11/01/2021	Assessment Status not visible	0
44	Status Completed JOINT	11/01/2021	Assessment Status not visible	0
45	Status Completed INSULATION	01/07/2020	Assessment Status not visible	0

No Segmentation Assessment found

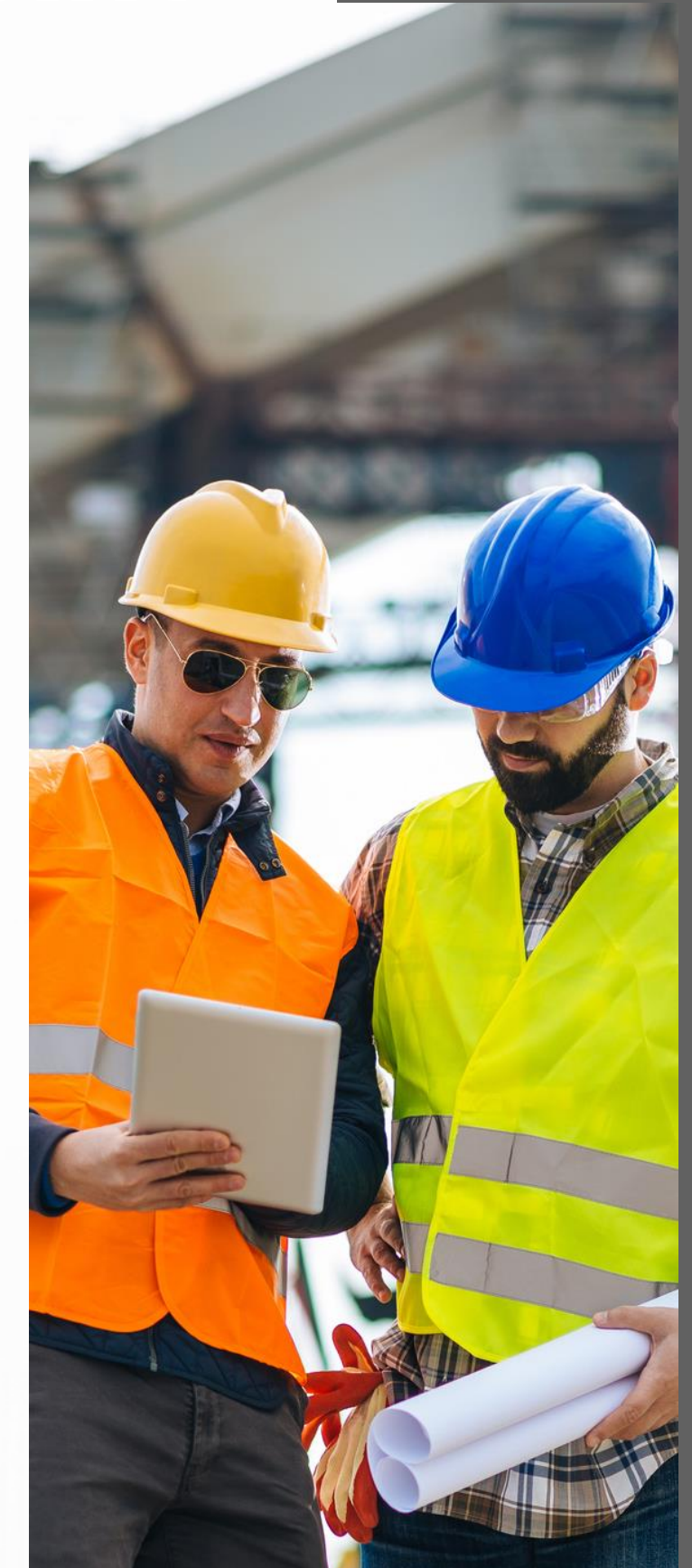



**شهادة مركب معتمد**

Date : 13/03/2019 التاريخ : 13/03/2019 م

\*CERTIFICATE\* \*شهادة\*

ARABIAN WATERPROOFING INDUSTRIES CO. شركة صناعات العزل العربية

**AWAZEL** عوازل

CERTIFIES THAT : تشهد بأن :

**GULF CRETE LTD.** شركة خليج الخرسانة  
 For Construction, Maintenance Restoration Works للإشادات والصيانة  
 C.R 1010419075 جدة نجاد / 1010419075

P.O.BOX 285893 Riyadh 11323 11323 الرياض 285893 ب . ص

Tel: 011-4655034 Fax: 011- 2939553 هاتف/ 4655034-011 فاكس/ 2939553-011

Is an approved applicator of our products and systems in the following fields: - مقبول معتمد تركيب مواد وأظمة شركتنا في مجالات العمل التالية :-

- \*\* External Waterproofing systems for underground structures including basements, tunnels, underground water tanks and swimming pools. العزل المائي للإشادات تحت الأرض وتشمل الأقبية والأشاق والخزانات الأرضية والمسابح من الخارج.
- \*\* - Waterproofing systems for concrete roofs of public buildings and private villas. العزل المائي للأسطح الخرسانية للمباني العامة والفيلات.
- \*\* - Waterproofing systems for metal decks of factories, warehouses and others. العزل المائي للأسطح المعدنية للمصانع والمستودعات وغيرها.
- \*\* - Waterproofing systems for bathrooms, kitchens and terraces. العزل المائي لدورات المياه والمطابخ والبلكونات.
- \*\* - Joint Sealing works. معالجة وصل. قوا وصل التمدد.
- \*\* - Protective coating systems for foundations. الدهانات الواقية للأساسات.

\* اعطيت هذه الشهادة بناء على طلب العميل دون ائدس مسؤولية على الشركة .

Arabian Waterproofing Industries Co. شركة صناعات العزل العربية

**AWAZEL** عوازل

Eng. Osama Al Bani م . أ.عامه الباني



Ref : KR/0513/05  
 Date : 22<sup>nd</sup> November 2014

**TO WHOM IT MAY CONCERN**

This is to certify that **M/s. Gulf Crete LTD.** is our approved and certified applicators for all Fosam Products for the following range of applications:

- Joint sealing works.
- Specialized protective coating for concrete and masonry.
- Epoxy Flooring
- Concrete Repair

This certificate is issued upon their request and without any liabilities on Fosam Company Limited and valid for three months from the date of issuance of this certificate.

Yours sincerely,  
 For **Fosam Company Limited**

**Kareem Rabayah**  
 Area Sales Manager-Central Region  
 Mobile: 0553829272

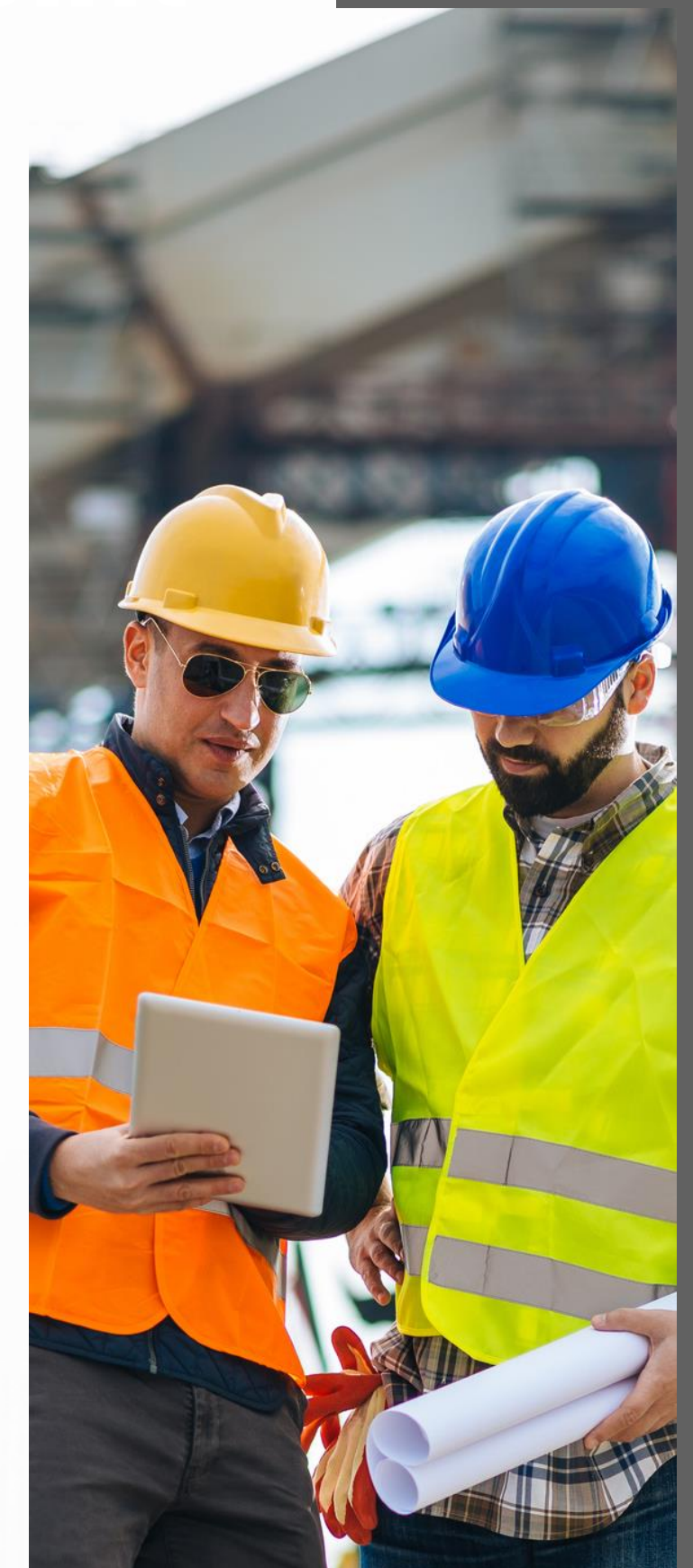



CERTIFICATION

شركة الصافي - دانون المحدودة  
Al Safi - Danone Co. Ltd.

بسرنا في فرع المدينة المنورة ان نتقدم بالشكر الجزيل لشركة خليج الخرسانه المحدودة (للانشاءات والصيانه ) فرع منطقة المدينة المنورة على ما قدموه من صيانة وتشطيبات للمستودعات الخاصه بالشركه بالاضافه الي الممرات والرمبات الخاصه بالشركه بالاضافه الي ( 75 متر ) مستودع خارجي تم تشطيب ارضيته بنويه الابوكسي وايضا بالاضافه الي ( 5 متر ) ابوكسي سكريت رامب تم تشطيبه وتجديده خارج العقد

وتم استلام المستودعات الاخرى من السيد ( سرور يار خان ) بصورة ممتازة من ناحية الارضيات والممرات والرسم الارضي وتحديد المسارات في داخل المستودعات

وتتمنى لكم دوام التوفيق والعطاء  
والسلام عليكم ورحمة الله وبركاته

مدير فرع المدينة المنورة

2017/11/03

عنوان: ١٠٤٦ الرياض ١١٤٦٣  
الخطوة التجارية السعودية  
شكافة: ٢٢٧٧ ١١ ٤٢٢  
فكس: ٢٢٢٩ ١١ ٢٢١

شركة ذات مسؤولية محدودة رأس المال المدفوع بالكامل (١٠٠٠٠٠٠٠٠ ريال سعودي)  
سجل تجاري رقم: (١٠١٠١٢٦٥) - رقم ضريبة المرفة التجارية ( ١٠١٤٢٩ )

United Systems Company - Paid Up Capital (SA 44,000,000)  
C.R.No.(1010123450) - C.C.No.(104274)  
www.alsafidanone.com

P.O.Box: 10625 Riyadh 11463  
Kingdom of Saudi Arabia  
Tel : +966 11 874 6777  
Fax : +966 11 270 5387

CERTIFICATION

RECEIVED  
26 JUL 2017  
Haram Contracting & Trading Co.

DOCUMENTS SUBMITTAL

PROJECT: Dr. Mohammed Alaghi Hospital  
CONTRACTOR: Hasmeh Contracting Co.

Transmittal of Drawings, Documents, Samples, etc.

DELIVERY	SUBMITTED FOR	CODE
Counter	APPROVAL	1
Revised Message	INFORMATION	2
Other	COORDINATION	3
	ACTION	CODE
	APPROVED	A
	APPROVED NOTED	B
	RESUBMIT	C
	DISAPPROVED	D
	FOR INFORMATION	E

Rev.	Qty.	Days / Items Reference	DESCRIPTION	Type	Code
1	1		CLINIC BUILDING GULF CRETE LTD CONTRACTING COMPANY Construction maintenance repair & restoration Pre-qualification of Gulf crete LTD • Cracks Injections at B1 slab part A		

For Your Kind Review & Approval

Remarks:

- Approved as a sub-Contractor for the purpose mentioned above.
- All pre-cautions, provisions and methodology mentioned in file data sheet of the approved repair material must be followed during repair process.
- A method of statement of the repair work to be submitted for approval prior to any commencement of work on site.

Reviewer's Signature: *[Signature]* Date: 23/07/2017  
Client Signature: *[Signature]* Date: 23/7/17

Type:  Stop Drawing  Sample  Manufacturer's Data  Certificate  Quotation  Other

Distribution:  CLIENT  CONTRACTOR

Contractor's Signature: *[Signature]* Date: 23 July 17





Date and Time Information

Date & Time of Print: 09/08/2021 14:08:21 - Time Zone: Arabia Time

Organisation Details

Organisation Name (English Input will be accepted only)	Gulf Crete Ltd
Trade Market Name (English Input will be accepted only)	Construction, Maintenance
Address	Riyadh
Country	SAUDI ARABIA
Region	Riyadh / منطقة الرياض
ZIP/Postal Code	11323
Main Organisation Phone Number	0114655034
Organisation Fax Number	0112939553
Organisation Email Address	gulfcrite@outlook.com
Web site	www.gulfcrite.com

Organisation Legal Structure

Private Limited or Limited Liability Company (شركة ذات مسؤولية محدودة)

Company Registration Number	1010419075
VAT Number	301099174300003

User Details

Title	Mr.
First Name	
Last Name	
Telephone	0114655034
Mobile	+966599281826
Email	shahrukh@gulfcrite.com
Username	shahrukh@gulfcrite.com
Preferred Language	English (UK)
Time Zone	(GMT + 3:00) Kuwait, Riyadh, Doha, Manama

Contact List

Last Name	First Name	Email	Phone Number
1		shahrukh@gulfcrite.com	0114655034

Registration Date

30/06/2020

List of Forms

No Forms found

Path	Category Title	Last Modification Date	Status Summary	Assessments Present
1	Status Completed MAINTENANCE AND REPAIR FACILITY	11/01/2021	Assessment Status not visible	0
2	Status Completed ADHESIVE AND SEALANTS	11/01/2021	Assessment Status not visible	1
3	Status Completed INTERIOR FINISHING	11/01/2021	Assessment Status not visible	1
4	Status Completed OPERATION AND MAINTINANCE	11/01/2021	Assessment Status not visible	1
5	Status Completed FIRE FIGHTING SYSTEMS	11/01/2021	Assessment Status not visible	1
6	Status Completed CARGO HANDLING FACILITIES	11/01/2021	Assessment Status not visible	1
7	Status Completed TERMINAL	11/01/2021	Assessment Status not visible	1
8	Status Completed CAR PARKING	11/01/2021	Assessment Status not visible	1
9	Status Completed CIVIL WORKS	11/01/2021	Assessment Status not visible	1
10	Status Completed ROOFING MATERIALS	01/07/2020	Assessment Status not visible	1
11	Status Completed PAINTS & COATING SUPPLIES	01/07/2020	Assessment Status not visible	1
12	Status Completed METAL/STEEL STRUCTURE	01/07/2020	Assessment Status not visible	1

Path	Title	Date	Status Summary	Present
13	Status Completed AIRPORTS CONTRACTING	01/07/2020	Assessment Status not visible	1
14	Status Completed MAIN,MINOR SEWERAGE, NETWORK	11/01/2021	Assessment Status not visible	1
15	Status Completed CAR PARKING,OTHER SHADES STRCT	01/07/2020	Assessment Status not visible	1
16	Status Completed HANGERS,WAREHOUSE WORKS	01/07/2020	Assessment Status not visible	1
17	Status Completed MAIN ROADS,STREETS RELATED WRK	11/01/2021	Assessment Status not visible	1
18	Status Completed COOLANT AND ADDITIVES	01/07/2020	Assessment Status not visible	1
19	Status Completed ADHESIVE AND SEALANTS	01/07/2020	Assessment Status not visible	1
20	Status Completed INFRASTRUCTURE,BUILDING WORKS	01/07/2020	Assessment Status not visible	1
21	Status Completed GEOPHYSICAL	11/01/2021	Assessment Status not visible	1
22	Status Completed CAR PARKING SYSTEM	01/07/2020	Assessment Status not visible	1
23	Status Completed JOINTING,PACKING	11/01/2021	Assessment Status not visible	1
24	Status Completed VESSELS AND TANKS	01/07/2020	Assessment Status not visible	1
25	Status Completed DIGGING AND PILING WORKS	11/01/2021	Assessment Status not visible	1
26	Status Completed RESIDENT ENGINEERING SERVICES	11/01/2021	Assessment Status not visible	1
27	Status Completed MASONRY,STONE WORK TILE	01/07/2020	Assessment Status not visible	1
28	Status Completed MAINTENANCE SERVICES	11/01/2021	Assessment Status not visible	1
29	Status Completed MATERIALS	01/07/2020	Assessment Status not visible	1
30	Status Completed CLADDING WORKS	01/07/2020	Assessment Status not visible	1
31	Status Completed FORWARDING FACILITY	11/01/2021	Assessment Status not visible	1
32	Status Completed GENERAL WORKS	01/07/2020	Assessment Status not visible	1
33	Status Completed INDUSTRIAL WORKS	01/07/2020	Assessment Status not visible	1
34	Status Completed ROAD MARKINGS	01/07/2020	Assessment Status not visible	1
35	Status Completed EXTERIOR RENOVATION WORKS	11/01/2021	Assessment Status not visible	1
36	Status Completed INTERIOR RENOVATION WORKS	11/01/2021	Assessment Status not visible	1
37	Status Completed FIRE SUPPRESSION SYSTEMS	11/01/2021	Assessment Status not visible	1
38	Status Completed CARPET AND FLOORING	11/01/2021	Assessment Status not visible	1
39	Status Completed TOPOGRAPHIC & OTHER	11/01/2021	Assessment Status not visible	1
40	Status Completed PAINT	01/07/2020	Assessment Status not visible	0
41	Status Completed SEALANT	11/01/2021	Assessment Status not visible	0
42	Status Completed SEALER	11/01/2021	Assessment Status not visible	0
43	Status Completed SEAL	11/01/2021	Assessment Status not visible	0
44	Status Completed JOINT	11/01/2021	Assessment Status not visible	0
45	Status Completed INSULATION	01/07/2020	Assessment Status not visible	0

No Segmentation Assessment found

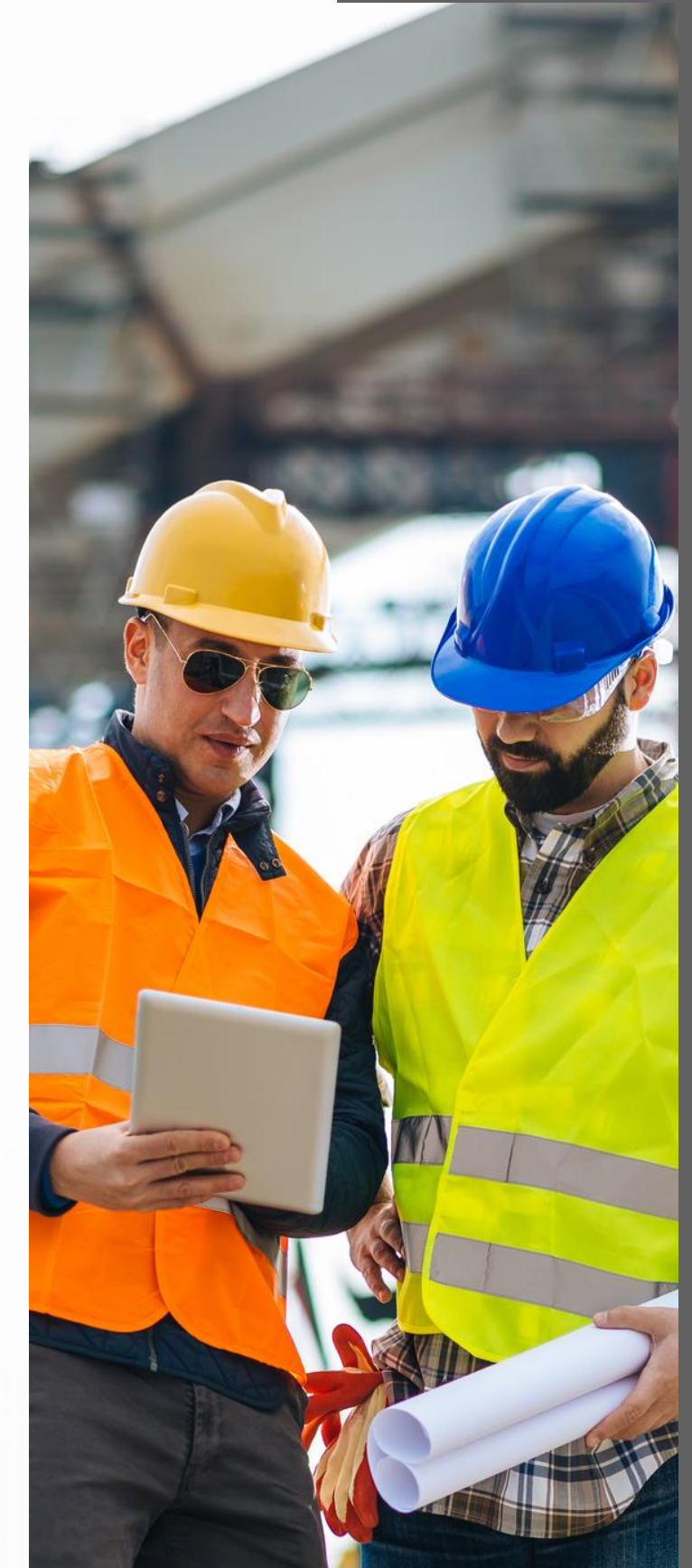

## Approved: Updates to SWCC - Supplier registration questionnaire



Ariba Administrator <no-reply@smtp.mn2.ariba.com>

To ● ShahRukh Ali Hassan

 Click here to download pictures. To help protect your privacy, Outlook prevented automatic download of some pictures in this message.

## SWCC

Hello ShahRukh Ali,

SWCC has approved the updates to SWCC - Supplier registration questionnaire that Alwaleed A. Al-Muhanna submitted on Wed, 04 Aug, 2021.

Best Regards,

SAP Ariba team

You are receiving this email because your customer, SWCC, has identified you as the appropriate contact for this correspondence. If you are not the correct contact, please contact SWCC.

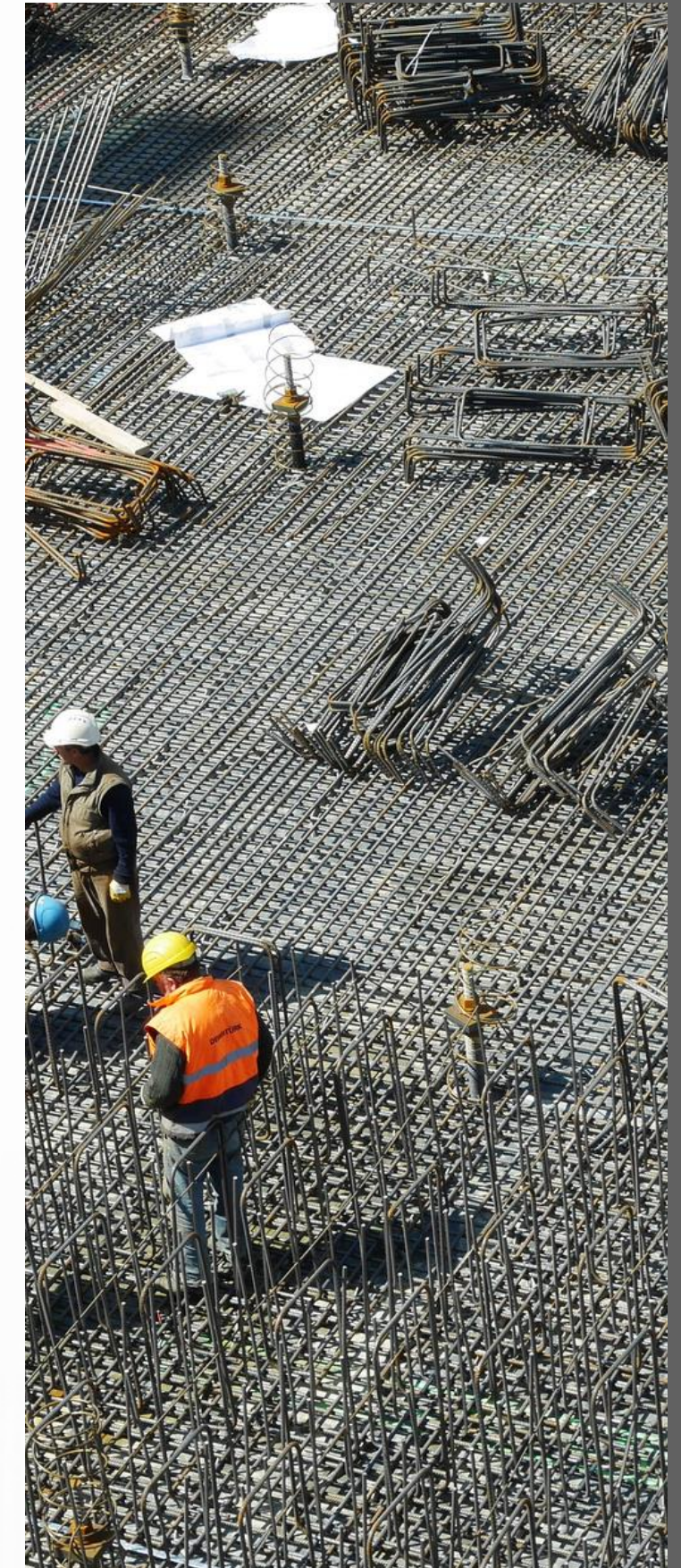



Client: National Housing Company		PMC: Dar al-handasah		Consultant: Khatib & Alami		General Contractor: Tamimi Global Company Ltd.	
MATERIAL SUBMITTAL							
AR	ME	CV	LA	Submittal No.	M	S	- 2 2 1 Rev. 0 0
ST	FE	QS	OT	Date: 7/13/2020	Contract Drawing No.		
To: Khatib & Alami				From: Tamimi Global Company Ltd.			
				List of Enclosures			
Specs./BOQ / Drawings Reference				Application for: Roof Insulation / waterproofing (Precast, Fursa, Buildings). Specification Ref. as per project specification (Sec.075700). BOQ Reference(s): MURCIA BOQ Drawing Ref.:			
Specified Material				<input checked="" type="checkbox"/> PU.Foam, Acrylic / Cementitious Coating.			
Proposed Material				<input checked="" type="checkbox"/> PU.Foam, Acrylic / Cementitious Coating.			
Manufacturer / Local Supplier				<input checked="" type="checkbox"/> GULF CRETE LTD.THE SPECIALIZED.CO			
Reasons for Alternative (if any)				<input checked="" type="checkbox"/>			
Contractor's Remarks:				<input checked="" type="checkbox"/>			
Contractor Incoming Signature: [Signature]				Contractor Outgoing Signature: [Signature]			
Date: 16/12/20				Date: 16/12/20			
<p>THE FOLLOWING MATERIAL HAVE BEEN APPROVED: POLYFOAM 20, POLYUREA, ALYAF.</p> <p>CALCULATION OF U-VALUE ARE WITHIN SBC 602, AS PROVIDED BY CONTRACTOR.</p> <p>MOCKUP SAMPLE WITH TEST TO BE DONE PRIOR ANY DELIVERY.</p> <p>COMPLETE SECTIONS AND DETAILS TO BE SUBMITTED ASAP.</p> <p>SUBJECT TO NEGATIVE VARIATION ORDER INLG TO REMOVAL OF SBS WATERPROOF MEMBRANE. NEGATIVE ORDER TO BE FINISHED PRIOR ANY INVOICING.</p>							
For K&A: [Signature]				Date: 16/12/20			
ACTION CODE: A = Approved <input type="checkbox"/> C = Resubmit as Noted <input type="checkbox"/> E = No action taken <input type="checkbox"/> B = Approved as noted <input checked="" type="checkbox"/> D = Disapproved <input type="checkbox"/> F = Retained for Info. <input type="checkbox"/>							

CERTIFICATION

**KING ABDULLAH FINANCIAL DISTRICT**

**DOCUMENT SUBMITTAL FORM**

Contract No: DB16P111      Work Package: DB16P111  
 Title: PRE-QUALIF GULF CRETE LTD.CONTRACTI      Submittal Number: DB16P111-DC-A-0088  
 From: Saudi Binladin Group      Rev.: 0  
 To: Dar Al-Riyadh      Date: 03/Dec/2014  
 Attn: Dar Al-Riyadh      Submittal Package: DOC      No. of Copies: 3

**DOCUMENT DETAILS**

Category: Prequalification      Specification: N/A  
 Discipline: ( A ) ARCH      BOQ Ref. No.: N/A  
 Parcel No: 1.11      Building: 1.11      Drawing Ref.: N/A

We certify that the above submitted items have been reviewed in detail and are correct and in strict conformity with the contract drawings and specifications except otherwise stated.

**For the Contractor**

Name: Syed Ahsan saeed      Signature: [Signature]      Date: [Date]

Notes: PRE-QUALIFICATION FOR GULF CRETE LTD. CONTRACTING COMPANY\_FIRE PAINT CO.LTD FOR BAKELITE

**CONSULTANT'S COMMENTS**

1- Gulf Crete Ltd. Co. - complied w/ the Project Tech'l Specs.  
 2- To ensure that the company (GCLCC) is Pre-Qualified and to be Approved by the Client.

**Approval Code**

Approved       Approved As Noted       Revise - Resubmit  
 Rejected - Resubmit       Receipt Acknowledged

Name: [Signature]      Signature: [Signature]      Date: 20/12/14

**PM / SMT REVIEW**

Name: \_\_\_\_\_ Signature: \_\_\_\_\_ Date: \_\_\_\_\_

**OWNER'S COMMENTS (Optional)**

Name: \_\_\_\_\_ Signature: \_\_\_\_\_ Date: \_\_\_\_\_

Approval shall not relieve the contractor of its obligations and liabilities under the Contract or constitute authorization of any change to Contract Documents, and therefore, shall not imply any recognition whatsoever of additional time or cost to the Contract.

**Distribution**

Owner     PM / SMT     Engr/Const.     Contractor

**To Contractor**

Received by: [Signature]      Date: 21 DEC 2014  
 Document Controller: [Signature]      Date: 21 DEC 2014

PP-DC-08-FM Rev. 1





# TRAINING CERTIFICATION





hereby confirms the company



Construction, Maintenance & Restoration  
للانشاءات و الصيانه

based in Riyadh, Saudi Arabia is a Certified Applicator of Waterproofing,  
Repair, and Protection System,

that has successfully completed the theoretical and technical training to  
apply the Penetron Crystalline Growth Waterproofing Systems:

**PENETRON, PENETRON ADMIX, PENEKRETE MORTAR, PENEPLUG,  
PENEBAR, PENESEAL, & PENETRON INJECT**

This Certificate No. PEN/ME/CERT-020 is given on 28<sup>th</sup> NOVEMBER 2022  
valid until 27<sup>th</sup> NOVEMBER 2023.

Sam Annous  
Managing Director – GCC



Marinos Tseregounis  
Technical Sales Director - Asia Pacific

**PENETRON INTERNATIONAL MIDDLE EAST DMCC**

German Arabian Serviced Offices DMCC-30th Floor, Office 006, Plot Y3, JLT, Dubai, U.A.E.  
+971 54 466 4101 • [penetron.com](http://penetron.com) • [sannous@penetron.com](mailto:sannous@penetron.com)

These commodities, technology, or software were exported from the United States in accordance  
with the Export Administration Regulations. Diversion contrary to U.S. law is prohibited.



hereby confirms the company



**E.A. JUFFALI & BROTHERS CO.**

based in Jeddah, Saudi Arabia is a Certified Distributor of Waterproofing,  
Repair, and Protection System,

that has successfully completed the theoretical and technical training to  
apply the Penetron Crystalline Growth Waterproofing Systems:

**PENETRON, PENETRON ADMIX, PENEKRETE MORTAR, PENEPLUG,  
PENEBAR, PENESEAL, & PENETRON INJECT**

This Certificate No. PEN/ME/CERT-021 is given on 28<sup>th</sup> NOVEMBER 2022  
valid until 27<sup>th</sup> NOVEMBER 2023.

Sam Annous  
Managing Director – GCC



Marinos Tseregounis  
Technical Sales Director - Asia Pacific

**PENETRON INTERNATIONAL MIDDLE EAST DMCC**

German Arabian Serviced Offices DMCC-30th Floor, Office 006, Plot Y3, JLT, Dubai, U.A.E.  
+971 54 466 4101 • [penetron.com](http://penetron.com) • [sannous@penetron.com](mailto:sannous@penetron.com)

These commodities, technology, or software were exported from the United States in accordance  
with the Export Administration Regulations. Diversion contrary to U.S. law is prohibited.

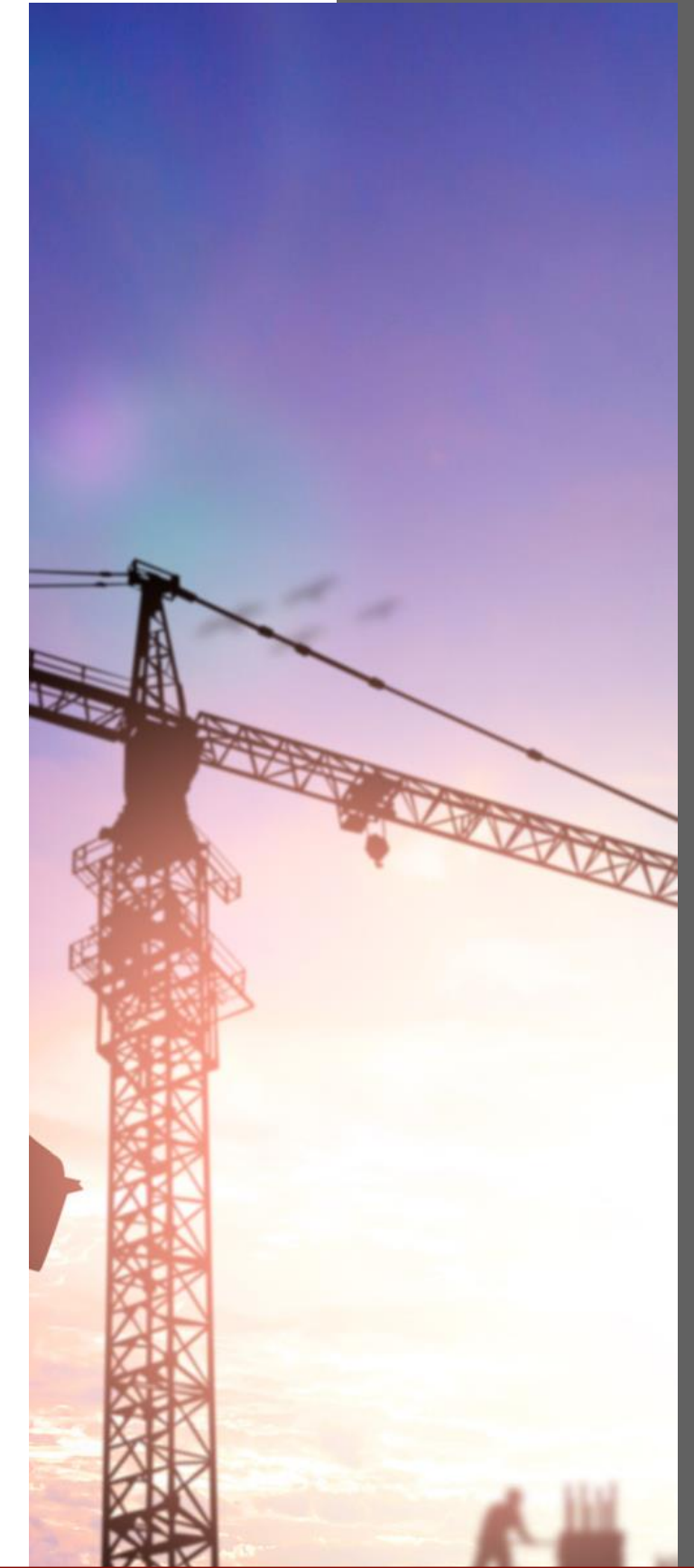

# CERTIFICATE

FOR RECOMMENDED SIKA APPLICATORS

This is to certify that key people of the company  
**GULF CRETE CONTRACTING**

successfully passed the applications training of the following Sika Products and is Recommended Sika Applicator:

**SARNAFIL MECHANICALLY FASTENED & FULLY ADHERED SYSTEMS ,SIKAPLAN WATERPROOFING SYSTEM**

This comprehensive training consisted of practical instructions about proper storage, preparation and application of Sika products.

The recommended applicator has been provided with the relevant Sika Product Data Sheets and all other technical documentation.

This confirmation is valid until the date of expiry below and may be renewed subject to the Recommended Applicator successfully completing any training courses required by Sika. The Recommended Applicator is responsible for ensuring full compliance by its employees with Sika's guidelines, training instructions and any other requirements of third parties.

Sika is not responsible for any loss or damage suffered by any third party as a result of any acts or omissions of the Recommended Applicator arising in anyway, including but not limited to breach of contract, misrepresentation, failure to comply with applicable laws or any other tort including negligence.

KSA, January 18, 2017

Expiry Date: 31 December 2017



Hossam Ali  
Technical & Specifications Manager KSA



Stevan Zivkovic  
General Manager-Sika Saudi Arabia Co. Ltd

This Recommendation does not assume responsibility for the correct storage, mixing or use of these Products. Sika shall not be liable for damage to persons or property, loss of business or profit or any other direct, indirect, incidental, special or consequential damage or caused by the Recommended Applicator. Sika shall also not be responsible for use of these Products in a manner to infringe on any patent or other intellectual property rights held by others. Sika's liability is limited to the quality only of the supplied material. Any failures due to wrong application or storage not in accordance with the given guidelines as stated on the latest Technical Data Sheets, as well as structural or mechanical failures are excluded herein.

BUILDING TRUST



# CERTIFICATE

FOR PROVISIONAL SIKA APPLICATORS

This is to certify that key people of the company

**GULF CRETE CO.**

successfully passed the applications training of the following Sika Products and is Provisional Sika Applicator:

**SIKACRETE,SIKAGROUT, SIKAFLOOR 263SL  
SIKAFLOOR 264**

This comprehensive training consisted of practical instructions about proper storage, preparation and application of Sika products.

The Provisional applicator has been provided with the relevant Sika Product Data Sheets and all other technical documentation.

This confirmation is valid until the date of expiry below and may be renewed subject to the Provisional Applicator successfully completing any training courses required by Sika. The Provisional Applicator is responsible for ensuring full compliance by its employees with Sika's guidelines, training instructions and any other requirements of third parties.

Sika is not responsible for any loss or damage suffered by any third party as a result of any acts or omissions of the Provisional Applicator arising in anyway, including but not limited to breach of contract, misrepresentation, failure to comply with applicable laws or any other tort including negligence.

KSA, January 22, 2017

Expiry Date: December 31,2017

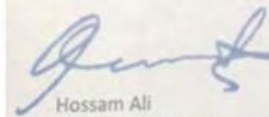

Hossam Ali  
Technical & Specifications Manager KSA

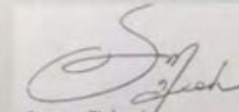

Stevan Zivkovic  
General Manager-Sika Saudi Arabia Co. Ltd

This Recommendation does not assume responsibility for the correct storage, mixing or use of these Products. Sika shall not be liable for damage to persons or property, loss of business or profit or any other direct, indirect, incidental, special or consequential damage or caused by the PROVISIONAL Applicator. Sika shall also not be responsible for use of these Products in a manner to infringe on any patent or other intellectual property rights held by others. Sika's liability is limited to the quality only of the supplied material. Any failures due to wrong application or storage not in accordance with the given guidelines as stated on the latest Technical Data Sheets, as well as structural or mechanical failures are excluded herein.

BUILDING TRUST



# CERTIFICATE

SIKA CARBODUR® S & SIKAWRAP® RANGE TRAINING ATTENDANCY

This is to certify that

**MR.ABDALLAH MOHD RASMI A ALKOUSA  
OSMAN OMER OSMAN SALIH  
AURANGZAIB SARWAR SARWAR YAR KHAN  
AURANGZAIB SARWAR SARWAR YAR KHAN  
MUHAMMAD JAMAL ZAIB AURANGZAIB SARWAR  
JAWAID IQBAL KHAN  
ASIF SHER AFSAR SHER**

Successfully passed the

**INSTALLATION OF SIKA CARBODUR S AND SIKAWRAP RANGE**

This comprehensive training consisted of presentations and workshops which included the following:

- Systems Description and components.
- Equipment Tools.
- Appliances & Components and general application guides
- On-site Checklist for Equipment and Materials

This training was conducted by Sika KSA LLC in May 9<sup>th</sup> 2017 Sika Saudi Arabia Co. Ltd.



# CERTIFICATE

FOR PROVISIONAL SIKA APPLICATORS

This is to certify that key people of the company

**CONCRETE GULF LIMITED(GULF CRETE).**

Successfully passed the applications training of the following Sika Products and is Provisional Sika Applicator:

**SIKA CARBODUR® S & SIKAWRAP® RANGE**

This comprehensive training consisted of practical instructions about proper storage, preparation and application of Sika products.

The Provisional applicator has been provided with the relevant Sika Product Data Sheets and all other technical documentation.

This confirmation is valid until the date of expiry below and may be renewed subject to the Provisional Applicator successfully completing any training courses required by Sika. The Provisional Applicator is responsible for ensuring full compliance by its employees with Sika's guidelines, training instructions and any other requirements of third parties.

Sika is not responsible for any loss or damage suffered by any third party as a result of any acts or omissions of the Provisional Applicator arising in anyway, including but not limited to breach of contract, misrepresentation, failure to comply with applicable laws or any other tort including negligence.

KSA, May, 2017

Expiry Date: December, 2017

Hossam Ali  
Technical & Specifications Manager KSA

Stevan Zivkovic  
General Manager-Sika Saudi Arabia Co. Ltd

This recommendation does not assume responsibility for the correct storage, mixing or use of these Products. Sika shall not be liable for damage to persons or property, loss of business or profit or any other direct, indirect, incidental, special or consequential damage or caused by the PROVISIONAL Applicator. Sika shall also not be responsible for use of these Products in a manner to infringe on any patent or other intellectual property rights held by others. Sika's liability is limited to the quality only of the supplied material. Any failure due to wrong application or storage not in accordance with the given guidelines as stated on the Sika Technical Data Sheets, as well as structural or mechanical failures are excluded herein.





hereby confirms the company



Construction, Maintenance & Restoration  
للانشاءات و الصيانه

based in Riyadh, Saudi Arabia is a Certified Applicator of Waterproofing,  
Repair, and Protection System,

that has successfully completed the theoretical and technical training to  
apply the Penetron Crystalline Growth Waterproofing Systems:

**PENETRON, PENETRON ADMIX, PENECEMTE MORTAR, PENEPLUG,  
PENESEAL, & PENETRON INJECT**

This Certificate No. PEN/ME/CERT-020 is given on 28<sup>th</sup> NOVEMBER 2022  
valid until 27<sup>th</sup> NOVEMBER 2023.

Sam Annous  
Managing Director – GCC



Marinos Tseregounis  
Technical Sales Director - Asia Pacific

PENETRON INTERNATIONAL MIDDLE EAST DMCC  
German Arabian Serviced Offices DMCC-30th Floor, Office 006, Plot Y3, JLT, Dubai, U.A.E.  
+971 54 466 4101 • [penetron.com](http://penetron.com) • [sannous@penetron.com](mailto:sannous@penetron.com)

These commodities, technology, or software were exported from the United States in accordance  
with the Export Administration Regulations. Diversion contrary to U.S. law is prohibited.

[www.rowadplastic.com](http://www.rowadplastic.com)



شركة الرواد الدولية للأغشية الصناعية المحدودة  
Rowad International Geosynthetics Co. Ltd.

EFFECTIVE DATE: 01 January 2023

VALID UNTIL: 31 December 2023

## AUTHORIZED INSTALLER & DISTRIBUTOR CERTIFICATE

### To Whom It May Concern

Rowad International Geosynthetics Co. Ltd; is pleased to announce the appointment  
of:

**M/S Gulf Crete Ltd. Corporate**  
P.O.Box 285893 Riyadh 11323, Saudi Arabia  
Email: [morsy@gulfcrete.com](mailto:morsy@gulfcrete.com)

as an **Authorized Dealer and Specialist Installer** for supply and Installation of  
**Rowad Geosynthetic Liners** such as:  
HDPE Linings (Smooth and Textured)  
LLDPE (Smooth and Textured)  
And any other products that Rowad develop from time to time.

We are proud to be associated with **M/S Gulf Crete Ltd. Corporate** and wish  
them every success in developing business avenues with the client.

Eng. Firas Ghazouani, MBA  
Sales & Marketing Manager

Rowad International Geosynthetics Co. Ltd.



صندوق بريد 14164 الرياض 31424 المملكة العربية السعودية، ت: +966 13 812-1360 - ف: +966 13 812-1759، سجل تجاري: 2050071569 - عضوية: 137373

P.O. Box 14164 Dammam 31424 Saudi Arabia, T: +966 13 812-1360 - F: +966 13 812-1759. C.R.: 2050071569 - C.M.: 137373









# Assessment & Engineering DEP.



## TABLE OF CONTENTS

CONDITION ASSESSMENT & INSPECTION SERVICES	04
NON-DESTRUCTIVE TESTING	05
BRIDGE LOAD TEST	06
BUILDINGS LOAD TEST	07
DURABILITY ANALYSIS	08
CONCRETE REPAIR	09
CATHODIC PROTECTION	10
STRUCTURAL STRENGTHENING	10
SOIL INVESTIGATION & REMEDIATION	11
3D ELECTRIC RESISTIVITY TOMOGRAPHY	12
ASSET MANAGEMENT SYSTEMS	13
STRUCTURAL WATERPROOFING-EXISTING STRUCTURES	14
STRUCTURAL WATERPROOFING-NEW CONSTRUCTION	15



## CONDITION ASSESSMENT & INSPECTION SERVICES

Our  
Services



The degradation of reinforced concrete material is a big challenge for owners who need to keep ageing structures in service and extend their life. RC condition assessment is a powerful decision-making process for engineers responsible for these types of structures. Exposure of these structures and reinforcing steel corrosion are well-known factors in the degradation of concrete civil engineering works, but it is difficult to quantify via conventional inspection methods (visual inspection and hammer sounding).



In fact, it is essential that during every condition assessment, a further step be taken towards understanding the in-depth anomalies in concrete and steel. Accordingly we state-of-the-art non-destructive testing Live instruments can be used to help conclude overall structural condition.



## NON-DESTRUCTIVE TESTING



### PROFOMETER

The all-in-one solution for rebar assessment and corrosion analysis.

#### Over view:

Advanced cover meter based on the new generation Profometer touchscreen with universal probe and scan cart. Enhanced correction factor for maximum cover accuracy on congested rebar arrangements. Dedicated functionalities for mapping concrete cover and for reporting one layer rebar arrangements.



### PROFOMETER CORROSION

The most advanced corrosion instrument in the market.

#### Over view:

Advanced half-cell measuring instrument for on-site mapping of the corrosion potential. Dedicated software for assisted measurements with rod and wheel electrodes. Statistical software for immediate data interpretation.



### PROCEQ GPR LIVE

The most innovative ultra-wideband portable GPR for concrete testing.

#### Over view:

The Proceq GPR Live portable ground penetrating radar instrument is the beginning of a new era in NDT. The outstanding, patented ultra-wideband technology combined with a compact wireless probe delivers unmatched industry performance. Just connect to your iPad and detect objects and back walls reliably, with amazing clarity and ease of use.



### PUNDIT LIVE ARRAY

**PRO**  
making pulse echo testing simpler and faster with Artificial Intelligence (A.I.)

#### Over view:

The Pundit Live Array Pro is a breakthrough in on-site productivity and image clarity for concrete NDT. The rugged, compact, wireless transducer array incorporates cutting-edge multi-channel Ultrasonic Pulse Echo technology.



### PUNDIT PL-200

The new Benchmark for Ultrasonic Pulse Velocity Testing

#### Over view:

The Pundit 200 is a best-in-class UPV test instrument with an extended range of measurement modes. Rugged touchscreen with intuitive user interface for best possible measuring and analysis of the measured data.



### ORIGINAL SCHMIDT LIVE

The world's most advanced R-value concrete test hammer

#### Over view:

The Original Schmidt Live is a uniquely versatile hammer that can be used as stand-alone analog hammer, a stand-alone digital hammer, together with a Bluetooth printer and finally as the world's most advanced R-value concrete test hammer with the Schmidt Live app.



**RESIPOD**

The world's most accurate concrete surface resistivity meter  
 Over view:  
 A complete solution for measuring the electrical resistivity of concrete both in the laboratory under controlled conditions and on site. Standard fixed spacing surface Wenner probe with variable spacing and bulk resistivity accessories.

**BRIDGE LOAD TEST**

Bridge load testing is a common structural evaluation technique usually done to measure physical properties of the bridge including deflections, strains, etc (Static and Dynamic load testing)... or to module and give a rating for the structure (through our diagnostic load test). It is usually carried out at the structure's different life phases including construction, maintenance, and repair stages. Structural Testing System (STS) has been designed expressly for performing live-load tests on highway and



railway bridges, piers, and marine loading structures. Developed through the experience of testing more than 300 Structures worldwide (U.S., Asia, Australia, India & Saudi Arabia), the system has been turned to perfection making it one of the most efficient and reliable testing methods in the structural analysis field.

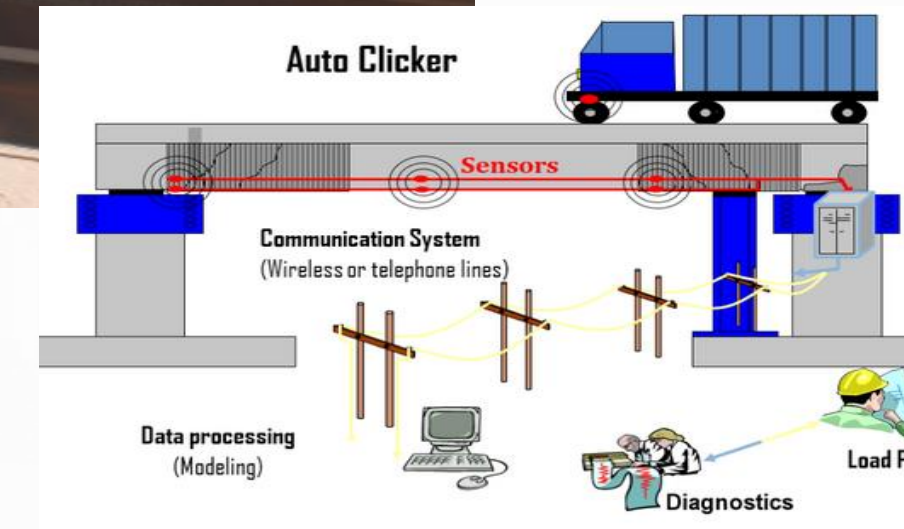



# BUILDINGS LOAD TEST

Over view:  
Load testing of building components or elements is a popular mean of demonstrating a structure's capabilities when a

- Structural strength is unknown.
- Impractical change of use involving an increase in loading
- Bomb or fire damage.
- Materials defect or structural deterioration.

simple analysis is not practical. Typical situation that arise include: Our services are as follows:

- Suspicion in performance such as excessive creep deflection
- Required dimensions and material properties can't be measured or tested.



## MEASUREMENTS

A set of response measurements shall be made after each load increment is applied and after the total load has been applied. On the structure for at least 24 hours. Real-time monitoring of deflections and strains is usually undertaken for building load tests using smart sensors installed on the structure to be tested. Those instruments are connected to a data acquisition system which collects.

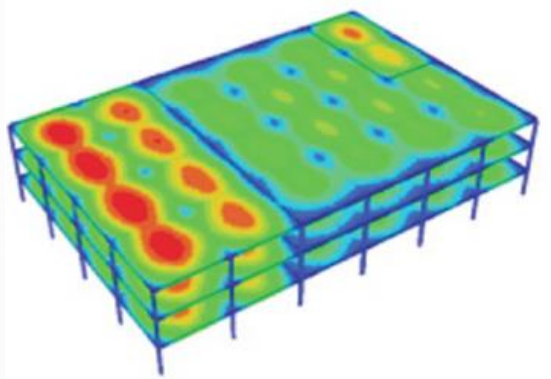



# DURABILITY ANALYSIS

With years of experience, Co-mender's Team recognized that the durability of concrete structures is related not only to design and material but also to construction issues. Upon completion of new concrete structures, the achieved construction quality always shows a high scatter and variability, and in severe environments, any weaknesses in the concrete structures will soon be revealed in the final condition of the structure whatever specifications and constituent materials have been applied.

Our Services

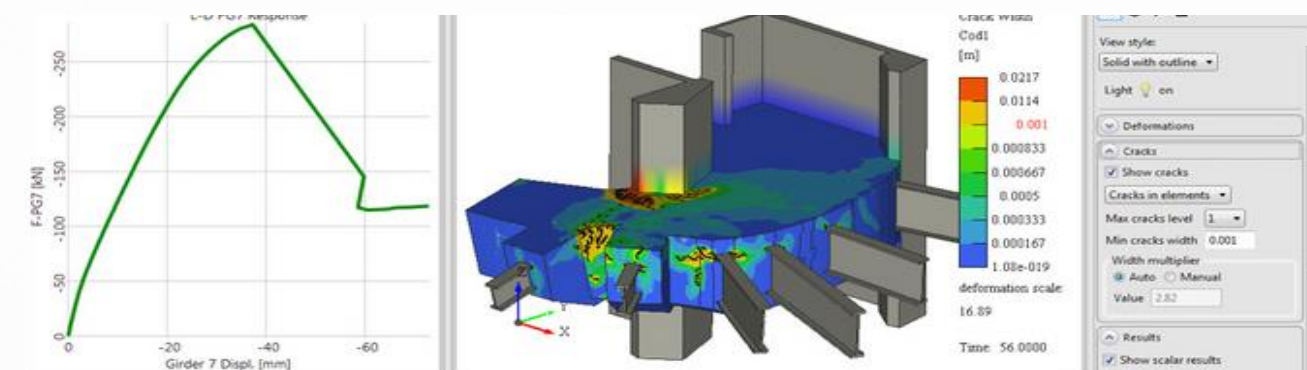
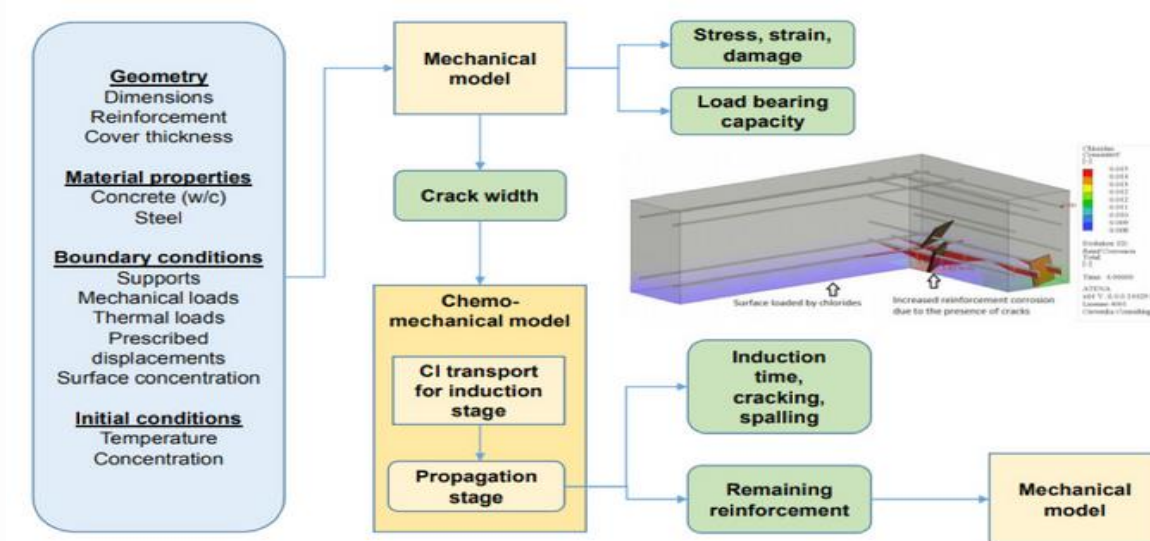

In order to better take all this variability into account and to evaluate durability analysis combined with structural analysis software should be applied.

our experts and in collaboration with its local engineers and with the aid of its communication technology can provide its customers with full comprehensive service for better concrete quality and better construction practices in new construction sites and to evaluate remaining life and residual strength in existing structures.







## CONCRETE REPAIR

Our Services

Deterioration in concrete is a big challenge and a major concern for structures and utilities owners especially when it reaches an advanced stage and starts causing an increase in shutdown and replacement costs and create a safety hazard for occupants.

with the aid of its advanced technologies, utilizes state-of-the-art materials, repair methods, tools and trained engineers to repair and restore concrete surfaces and structures.





## CATHODIC PROTECTION

Our Services



Cathodic protection reduces costs for future repair work construction in contrast to earlier, when cathodic protection and extends the life expectancy of concrete structure. was only used as a method of repair. In both cases, Cathodic Many reinforced concrete structures suffer from premature protection efficiently stops ongoing corrosion and thus degradation, most commonly caused by chlorides. Today, degradation of concrete structure. cathodic protection is used by many building owners as an The system is comprised mainly of anodes, power supply integrated part of the maintenance strategy for reinforced and control units. concrete structures. We provide a full comprehensive service and supply wide range of anodes and equipment for existing Therefore, many reinforced concrete structures are prepared and new structures as well as customized power supplies for installation of cathodic protection already during the and control units.

## STRUCTURAL STRENGTHENING

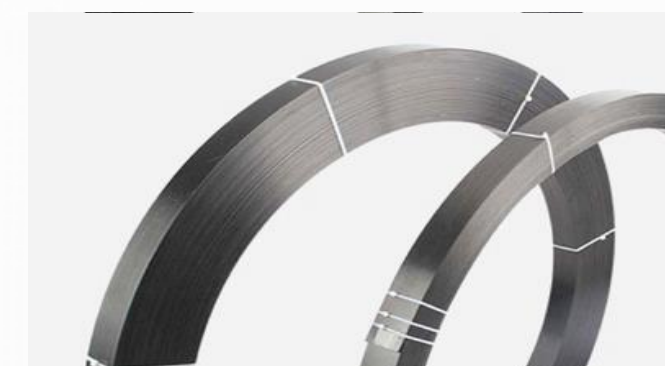

Many structures that originally were constructed for a specific use and loading level now are being renovated or upgraded for a different application that may require higher load-carrying capacity. As a result of these higher load demands, existing structures need to be reassessed and may

require strengthening to meet heavier load requirements. Business model is a perfect and highly efficient process that can provide our customers with a comprehensive solution including full Investigate – Design – Supply - Build capabilities.



# SOIL INVESTIGATION & REMEDIATION

Our Services

Over the last 20 years, our team has acquired solid experience in soil specialized areas, such as investigations, geotechnical studies and the various engineering phases associated with Solutions development. In the past two years only, the company completed interesting soil investigation and solutions development

for major structures, such as bridges, power plants and buildings. In our approach we use Non-destructive techniques such as ERT ( Electrical Resistivity Tomography ) and GPR ( Ground Penetrating Radar ) to better understand the subsurface condition.



Our Services

- Soil and geotechnical investigation
- Design of shallow and deep foundations
- Soil improvement and stabilization techniques
- Vibrations monitoring

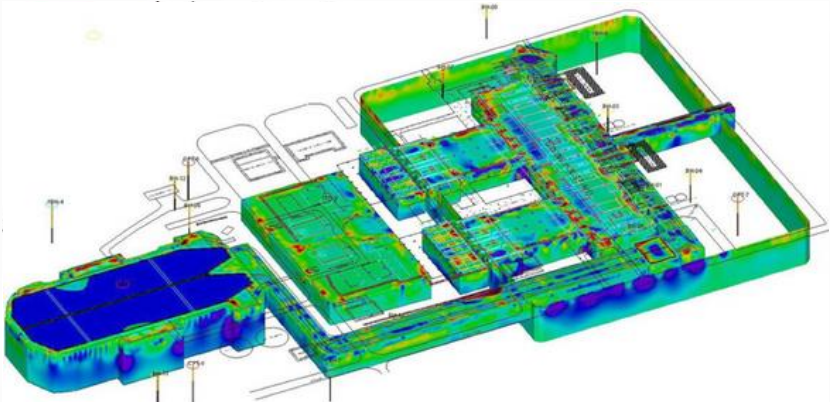



# 3D ELECTRIC RESISTIVITY TOMOGRAPHY

Our Services

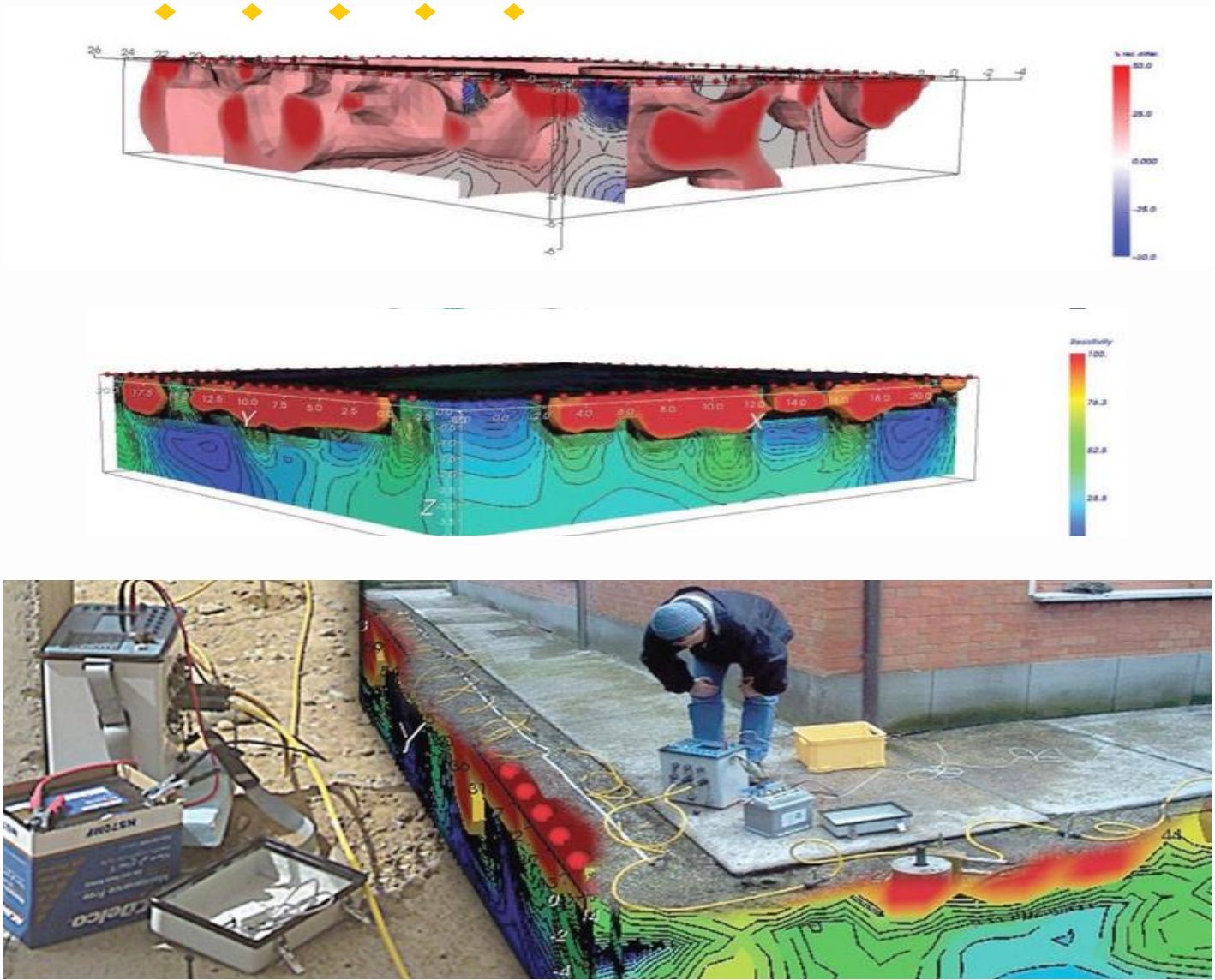

Characterization of subsurface soil and determination of soil strength are prerequisite for the foundation design of important civil engineering structures. Electrical characterization of soil is done by conducting surface electrical resistivity measurements and subsequently translating these data in terms of electrical properties of subsurface soil. Electric currents are injected into the ground and the resulting potential differences are measured at the surface, yielding information about the distribution of electrical resistivity below the surface. ERT involves repeated current injections through many electrode pair and into the region of interest (the ground) and the

recording of the potential distribution at all other electrodes for each current electrode pair. This procedure generates several electric potential images of the region of interest from different geometries of current injection. Analysis of these images is processed through a forward and an inverse algorithm. This combines all the data to yield 3-D resistivity distribution inside the studied region.

## APPLICATIONS

- Determination the location of buried faults
- Detection of voids and cavities in the subsurface Leak
- Detection ( water, fuel and others)
- Building Restoration Sites
- Real time monitoring of injection works



# ASSET MANAGEMENT SYSTEMS

Our Services

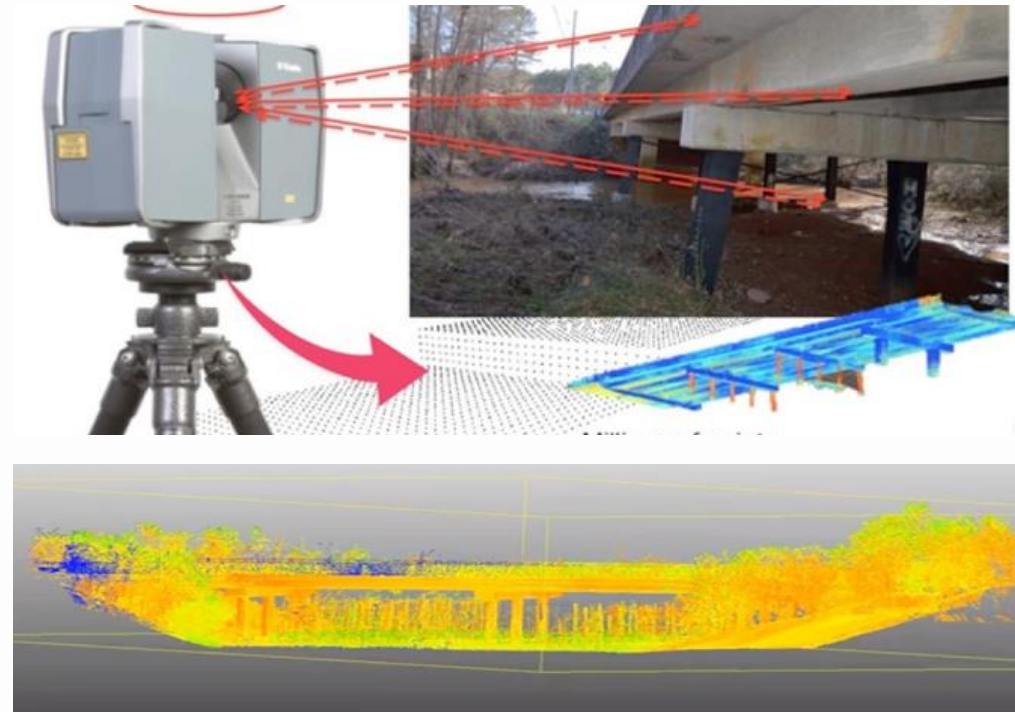

## INVENTORY MODULE

We host your existing asset management data online. We perform Initial Inspection to update these data. We Laser scan some/all the structures and develop 3D models. We decompose the 3D model using BIM.

## ANALYSIS MODULE

Our experts manage the structures. Analyze the collected data. Conduct Durability Analysis where needed. Prepare routine and detailed Inspection Schedule. Red flag critical structures. Use ComendX to Invite our local Inspectors to conduct the needed Inspection program.

Asset management is the process of making decisions on structure needs and arranging for resulting actions to occur at appropriate times. These may include maintenance, repair, rehabilitation, and replacement actions. Some routine maintenance actions are regularly scheduled, while other maintenance and repair actions are identified through the Department's Asset Inspection and Maintenance (AIM) system. Rehabilitation and replacement strategies are typically determined through an asset assessment that involves varying levels of analysis and engineering. All asset management decisions require inventory and inspection data on the structure to identify needs and appropriate actions. We and through our innovative business model, provides the owner's with the ability to manage their structures and making sure their inspection data are continuously updated without the need to hire a resident full time consulting firm. Our solution is comprised of four modules as follows:

## INSPECTION MODULE

Our local Inspectors receive the Inspection Schedule and inspection checklists on our ComendX App. Conduct the needed inspection and/or NDT. Uses ComendAIR AR to assign detected defects into the developed 3D model for the critical structure. Depending on availability, our experts can participate online using ComendAIR or alternatively make a virtual tour in the inspected structure.

## REPAIR MODULE

Our experts prepare the Inspection and testing results reports. Preparation of full repair strategy including B.O.Q. Inviting local partners to bid for the developed repair solution.



## STRUCTURAL WATERPROOFING-EXISTING STRUCTURES

Water can leak into and out of structures. Reasons for this can be cracks, failed joints and even through permeable substrates. Once identified, if not treated, further problems can occur including the corrosion of reinforcement, thus resulting in durability issues and consequential loss of a usable area within the structure.

we collaborates with solutions providers and provides comprehensive solutions for all your basements water leakages and durability issues.

Our  
Services

Our services are as follows:

- ◆ Full Condition assessment
- Durability Analysis
- Design of repair and waterproofing solutions
- Supply of materials and Technologies

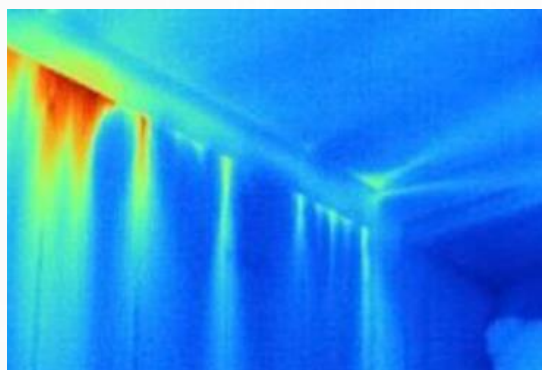
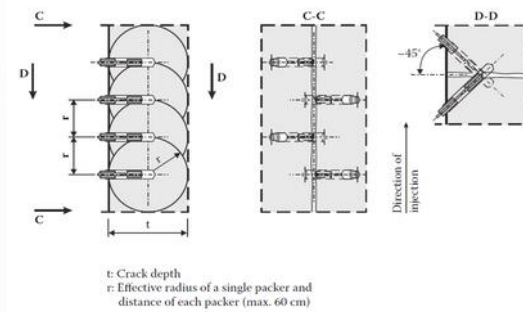



# STRUCTURAL WATERPROOFING-NEW CONSTRUCTION

Our Services

## ENGINEERING:

Engineering experts collaborate with designers and construction firms throughout all stages of design and construction and provides the following services:

- General advices on the design of underground structures.
- Design the additional post-tensioning system for vertical walls to reduce or eliminate cracking
- Revision and approval of concrete mix design
- Review the reinforcing bars detailing for shrinkage requirements.
- Review the design of the jointing system and introducing cracks inducers if needed
- Construction management including recording of data, photographs and plans for laying all our technologies systems.

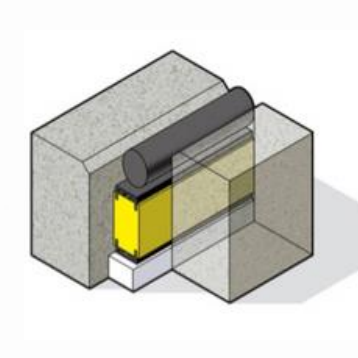
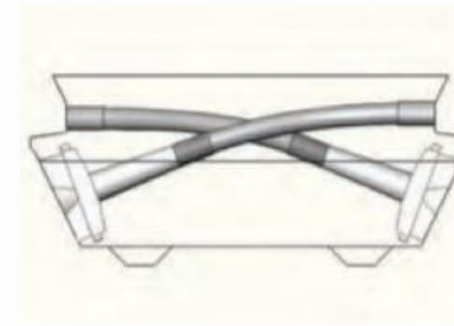

### WATERPROOF CONCRETE

engineering team reviews the mix design, conducts trial mixes and advises our customers with the use of our crystalline waterproofing admixtures where needed.

Also, we provide, monitoring of the concrete temperature and maturity Experts Supervision of the concrete quality, both on-site during construction and testing in the laboratory using our Co-mendAIR technology.

### POST-TENSIONING SYSTEM

and in collaboration with its partner OVM-MENA have developed a special post-tensioning system that can be applied to vertical walls and reduces the amount and width of cracking.

Similarly to post-tensioned water-tanks the cracks in basement walls can be better controlled or even eliminated providing better durability and functionality to the basement spaces.

### WATERSTOP

Joints and penetrations are the most critical elements in the below grade waterproofing system.

Special attention is needed in the design phase and construction phase to achieve a sealed joints. Co-mender's joints sealing system is carefully selected for both durability and performance.

### TECHNOLOGY

After designing the full waterproofing system and reviewing all its essential components, Co-mender provides its international waterproofing experts live and easy access to the site operations during concrete placement .

It's smart monitoring system and live connectivity with the site team allow the experts to provide their technical advice right on the spot eliminating a lot of possible concrete quality issues at site.

# Augmented Reality -AR

AR is set to 'fundamentally change' industrial jobs in the next five years



Smart  
Helmet







**GULF CRETE LTD.**

شركة خليج الخرسانه المحدوده

## CONTACT US



+966 114 655 034



Gulfcrete.com



Info@Gulfcrete.com



GULFCRETE



SCAN ME

# THANK YOU

WWW.GULFCRETE.COM

